

MAN
MEF

Department of Commerce
National Marine Fisheries Service
SEP 05 2003
Southwest Fisheries Science Center
La Jolla, California

NOAA Technical Memorandum NMFS



MAY 2003

**ICHTHYOPLANKTON AND STATION DATA FOR
SURFACE (MANTA) AND OBLIQUE (BONGO) PLANKTON TOWS FOR
MINI-CALIFORNIA COOPERATIVE OCEANIC FISHERIES INVESTIGATIONS
SURVEY CRUISES IN 1997 AND 1998**

David A. Ambrose
Richard L. Charter
H. Geoffrey Moser

NOAA-TM-NMFS-SWFSC-351

U.S. DEPARTMENT OF COMMERCE
National Oceanic and Atmospheric Administration
National Marine Fisheries Service
Southwest Fisheries Science Center

The National Oceanic and Atmospheric Administration (NOAA), organized in 1970, has evolved into an agency which establishes national policies and manages and conserves our oceanic, coastal, and atmospheric resources. An organizational element within NOAA, the Office of Fisheries is responsible for fisheries policy and the direction of the National Marine Fisheries Service (NMFS).

In addition to its formal publications, the NMFS uses the NOAA Technical Memorandum series to issue informal scientific and technical publications when complete formal review and editorial processing are not appropriate or feasible. Documents within this series, however, reflect sound professional work and may be referenced in the formal scientific and technical literature.



NOAA Technical Memorandum NMFS

This TM series is used for documentation and timely communication of preliminary results, interim reports, or special purpose information. The TMs have not received complete formal review, editorial control, or detailed editing.

MAY 2003

ICHTHYOPLANKTON AND STATION DATA FOR SURFACE (MANTA) AND OBLIQUE (BONGO) PLANKTON TOWS FOR MINI-CALIFORNIA COOPERATIVE OCEANIC FISHERIES INVESTIGATIONS SURVEY CRUISES IN 1997 AND 1998

David A. Ambrose, Richard L. Charter, and H. Geoffrey Moser

National Oceanic and Atmospheric Administration
National Marine Fisheries Service
Southwest Fisheries Science Center
8604 La Jolla Shores Drive
La Jolla, California, USA 92037

NOAA-TM-NMFS-SWFSC-351

U.S. DEPARTMENT OF COMMERCE

Donald L. Evans, Secretary

National Oceanic and Atmospheric Administration

VADM Conrad C. Lautenbacher, Jr., Undersecretary for Oceans and Atmosphere

National Marine Fisheries Service

William T. Hogarth, Assistant Administrator for Fisheries

CONTENTS

	Page
List of Figures	iii
List of Tables	iii
Abstract	1
Introduction	1
Sampling Area and Pattern	3
Sampling Gear and Methods	3
Laboratory Procedures	4
Identification	5
Species Summary	7
Explanation of Tables	8
Acknowledgments	9
Literature Cited	9
Figures	17
Tables	23
Phylogenetic Index to Tables 4 and 8	65
Alphabetical Index to Tables 4 and 8	68

LIST OF FIGURES

	Page
Figure 1. Diagram of the Manta net used on CalCOFI surveys	17
Figure 2. Stations and cruise tracks for CalCOFI cruises 9712 and 9803	18
Figure 3. Stations and cruise tracks for CalCOFI cruises 9805 and 9806	19
Figure 4. Stations and cruise tracks for CalCOFI cruises 9808 and 9810	20
Figure 5. Stations and cruise tracks for CalCOFI cruises 9811 and 9812	20
Figure 6. Basic station plan for CalCOFI cruises	22

LIST OF TABLES

	Page
Table 1. Station and Manta tow data for Mini-CalCOFI survey cruises in 1997 and 1998	23
Table 2. Pooled occurrences of fish larvae taken in Manta net tows on Mini-CalCOFI survey cruises in 1997 and 1998	27
Table 3. Pooled counts of fish larvae taken in Manta net tows on Mini-CalCOFI survey cruises in 1997 and 1998	28
Table 4. Numbers of fish larvae (per 100 m ³) taken in Manta net tows on Mini-CalCOFI survey cruises in 1997 and 1998 listed by taxon, station, and month	29
Table 5. Station and Bongo tow data for Mini-CalCOFI survey cruises in 1997 and 1998	35
Table 6. Pooled occurrences of fish larvae taken in Bongo net tows on Mini-CalCOFI survey cruises in 1997 and 1998	40
Table 7. Pooled standardized counts of fish larvae taken in Bongo net tows on Mini-CalCOFI survey cruises in 1997 and 1998	43
Table 8. Standardized counts of fish larvae taken in Bongo net tows on Mini-CalCOFI survey cruises in 1997 and 1998 listed by taxon, station, and month	46

ABSTRACT

This report provides ichthyoplankton data from Manta net tows (surface) and Bongo net tows (oblique) and associated station and tow data from a series of eight “Mini-CalCOFI” survey cruises in the Southern California Bight region designed to monitor the response of the California Current to the 1997–1998 El Niño Southern Oscillation event. It is the 60th report in a series that presents these data for all biological-oceanographic CalCOFI surveys from 1951 to the present. A total of 122 stations was occupied on two transect lines extending in a southwesterly direction from Point Mugu (line 83.3) and Dana Point (line 90.0), California, to a maximum of approximately 250 n.mi. (station 100.0). The data are listed in a series of eight tables; the background, methodology, and information necessary for interpretation of the data are presented in an accompanying text. All pertinent station and tow data, including volumes of water strained and standard haul factors, are listed in the first and fifth tables. Other tables list, by station and month, counts (number per 100 cubic meters of water filtered) of each of the 37 larval fish taxa identified in Manta net tows and standardized counts (number under 10 m² of sea surface) of each of the 108 larval fish categories identified in Bongo net tows. This series of reports makes the CalCOFI ichthyoplankton and station data available to all investigators and serves as a guide to the computer data base.

INTRODUCTION

This report, the 60th in the series, provides ichthyoplankton and associated station and tow data from eight “Mini-CalCOFI” cruises designed to monitor the 1997–1998 El Niño Southern Oscillation event to supplement the standard California Cooperative Oceanic Fisheries Investigations (CalCOFI) joint biological-oceanographic survey cruises conducted during 1997–1998. This program was initiated in 1949, under the sponsorship of the Marine Research Committee of the State of California, to study the population fluctuations of the Pacific sardine (*Sardinops sagax*) and the environmental factors that may play a role in these fluctuations. CalCOFI is a partnership among the Southwest Fisheries Science Center of the National Marine Fisheries Service (NMFS), the Scripps Institution of Oceanography (SIO), and the California Department of Fish and Game (CDFG). NMFS and SIO supply ships and personnel to conduct the sea surveys, NMFS processes the plankton samples and analyzes the ichthyoplankton from them. SIO processes and analyzes hydrographic and biological samples and analyzes invertebrate groups from the plankton samples.

The boundaries, station placement, and sampling frequency for the CalCOFI surveys were based on the results of joint biological-oceanographic cruises conducted by NMFS and SIO during 1939–41. Originally, CalCOFI cruises were designed to collect sardine eggs and larvae and associated hydrographic data over the entire areal and seasonal spawning range of the species. From 1951 to 1960 the surveys were annual with cruises conducted monthly. The survey area was occupied quarterly during 1961–1965 and in 1966 the surveys became triennial with monthly cruises. Beginning in 1985 annual surveys were resumed, with quarterly cruises occupying only the Southern California Bight region (see Hewitt 1988 and Moser et al. 1993, 1994, 2001a, 2002 for summaries of CalCOFI historical sampling effort). Neuston¹ sampling with

¹Useage of term “neuston” for surface-living marine organisms is controversial because it was applied originally to organisms associated with the surface film in freshwater habitats (Naumann 1917). Banse (1975) reviewed in detail the evolution of this term, a related term “pleuston”, and the various subdivisions of each. Neuston is now used by most workers in referring to the uppermost (upper ~ 10 – 20 cm) layer of the sea and to the assemblage of organisms that lives in that zone, either permanently or facultatively (Zaitsev 1970; Hemple and Weikert 1972; Peres 1982; Doyle 1992b). We accept this definition and use it interchangeably with the more general term “surface” (e.g., Surface waters, surface zone, surface tow, surface assemblage).

the Manta (Figure 1) was initiated in 1977–1978. Alhstrom and Stevens (1976), Gruber et al. (1982), and Doyle (1992a,b) provided initial information on the distribution and abundance of surface ichthyoplankton in the northeastern Pacific. Moser et al. (2002) summarized the spatial and temporal distribution and abundance of ichthyoplankton collected in Manta net tows on CalCOFI survey cruises from 1977–2000.

Hydrographic and biological data from CalCOFI surveys in 1997–1998 have been published by the Scripps Institution of Oceanography (Univ. of Calif., SIO 1999a, b, c). All available records for all eight 1997–1998 Mini-CalCOFI surveys were verified and edited to produce this ichthyoplankton data report. These reports make the CalCOFI ichthyoplankton and station data available to all investigators and serve as guides to the computer data base. They are the basic documents against which changes in the data base can be compared as it is modified to correct errors and update earlier identifications. This report includes both Manta net tow data and Bongo net tow data, which prior to the 2001 report (Ambrose et al. 2003) were reported separately. Citations for other reports in this series are:

Survey	Manta Tow Report	Survey	Manta Tow Report
1977–78	Moser et al. 2000b	1992	Watson et al. 2002b
1980–81	Ambrose et al. 2002a	1993	Ambrose et al. 2002d
1984	Charter et al. 2002a	1994	Charter et al. 2002d
1985	Ambrose et al. 2002b	1995	Sandknop et al. 2002c
1986	Charter et al. 2002b	1996	Watson et al. 2002c
1987	Sandknop et al. 2002a	1997	Ambrose et al. 2002e
1988	Watson et al. 2002a	1998	Ambrose et al. 2002f
1989	Ambrose et al. 2002c	1999	Ambrose et al. 2002g
1990	Charter et al. 2002c	2000	Watson et al. 2002d
1991	Sandknop et al. 2002b	2001	Ambrose et al. 2003
Survey	Oblique Tow Report	Survey	Oblique Tow Report
1951	Ambrose et al. 1987a	1961	Sandknop et al. 1988a
1952	Sandknop et al. 1987a	1962	Sumida et al. 1988b
1953	Stevens et al. 1987a	1963	Ambrose et al. 1988a
1954	Sumida et al. 1987a	1964	Sandknop et al. 1988b
1955	Ambrose et al. 1987b	1965	Stevens et al. 1988a
1956	Stevens et al. 1987b	1966	Sumida et al. 1988b
1957	Sumida et al. 1987b	1967	Ambrose et al. 1988b
1958	Sandknop et al. 1987b	1968	Sandknop et al. 1988c
1959	Stevens et al. 1987c	1969	Stevens et al. 1988b
1960	Ambrose et al. 1987c	1972	Sumida et al. 1988c

Survey	Oblique Tow Report	Survey	Oblique Tow Report
1975	Ambrose et al. 1988c	1992	Watson et al. 1999b
1978	Sandknop et al. 1988d	1993	Ambrose et al. 1999c
1981	Ambrose et al. 1988d	1994	Charter et al. 1999c
1984	Stevens et al. 1990	1995	Sandknop et al. 1999c
1985	Ambrose et al. 1999a	1996	Watson et al. 1999c
1986	Charter et al. 1999a	1997	Ambrose et al. 1999d
1987	Sandknop et al. 1999a	1998	Charter et al. 1999d
1988	Watson et al. 1999a	1999	Ambrose et al. 2001
1989	Ambrose et al. 1999b	2000	Watson et al. 2001d
1990	Charter et al. 1999b	2001	Ambrose et al. 2003
1991	Sandknop et al. 1999b		

SAMPLING AREA AND PATTERN

A total of 122 standard CalCOFI survey stations was occupied on eight Mini-CalCOFI cruises in 1997–1998 employing the Scripps Institution of Oceanography research vessel *Robert Gordan Sproul* :

9712, 9 stations (9 Manta, 8 Bongo), December 13–15;

9803, 12 stations (11 Manta, 11 Bongo), March 11–16;

9805, 11 stations (11 Manta, 10 Bongo), May 16–21;

9806, 20 stations (20 Manta, 20 Bongo), June 17–22;

9808, 20 stations (19 Manta, 18 Bongo), August 12–17;

9810, 18 stations (18 Manta, 16 Bongo), October 16–21;

9811, 17 stations (16 Manta, 15 Bongo), November 18–23;

9812, 15 stations (15 Manta, 15 Bongo), December 10–15.

The survey area extended along two track lines off Point Mugu (line 83.3) and Dana Point (line 90.0), California, extending seaward in a southwesterly direction approximately 250 n.mi. (station 100.0)(Figures 2–5).² The initial cruise (9712) occupied only line 90.0 and extended seaward to station 80.0. Weather prevented sampling at certain stations on all subsequent cruises, except Cruise 9806 (Figures 2–5).

²Beginning in 1981 we changed our designation of ordinal survey lines (those ending in "3" and "7") to an exact decimal notation. Thus, lines 77, 83, 87, 93, etc. were changed to 76.7, 83.3, 86.7, 93.3, etc. to indicate the spacing between cardinal lines (those ending in "0"). Scripps Institution of Oceanography continues to use the original designation for ordinal lines (Figures 1 and 2 and see Univ. of Calif., SIO 2002a, b, c).

SAMPLING GEAR AND METHODS

Surface plankton tows were made with a modified version of the Manta net originally described by Brown and Cheng (1981). It consists of a rectangular mouth 15.5 cm deep and 86 cm wide attached to a frame that supports square lateral extensions covered with plywood and urethane foam (Figure 1). These extensions stabilize the net when it is towed and keep the top of the net at the sea surface. The net is constructed of 0.505 mm nylon mesh. The towing bridle is asymmetrical with one side longer than the other; when the net is towed this bridle arrangement forces the mouth away from the ship at a slight angle. A General Oceanics flowmeter was suspended across the center of the net mouth to measure the amount of water filtered during each tow. At each Manta tow station the tow line from the bridle was attached to the hydrographic wire and then lowered to slightly below the surface of the water before the net was deployed. The net was towed at a ship speed of 1.0–2.0 knots for 15 minutes. Samples were preserved in 5% buffered formalin and returned to the plankton sorting laboratory at the SWFSC at the end of the cruise.

In 1978, the standard 1-m ring net with towing bridle was replaced by a bridle-free "Bongo" net. The Bongo frame (McGowan and Brown 1966; Smith and Richardson 1977) consists of a pair of circular frames connected to a central axle. The axle is free to rotate so that the mouth openings are vertical during the tow. The standard CalCOFI net has 71 cm diameter frames and net material constructed of nylon mesh. Each net consists of a cylindrical section ~ 146 cm long, a truncated conical section ~ 161 cm long, and a detachable cod end. The starboard net, from which the standard sample is taken, is constructed of 0.505 mm mesh. The sample from the port side is used for other purposes; the mesh size is either 0.505 mm or 0.333 mm depending on requirements. The cod end of each net is constructed of 0.333 mm mesh.

The standard tow in 1997–1998 was a double oblique haul to 212 m depth (to 15 m from the bottom in shallow areas) designed to filter a constant amount of water per depth interval (~ 2 m³/m of depth) over the vertical range of most ichthyoplankters. Hauls were made at a ship speed of 1.5–2.0 knots and initiated by clamping the net to the towing cable above a 34 kg weight suspended below the surface. The net was lowered to ~ 210 m depth by paying out 300 m of wire at 50 m/minute (35 m of depth/minute). After fishing at depth for 30 seconds, the net was retrieved at 20 m/minute (14 m of depth/minute). The angle of stray was recorded every 30 seconds and maintained at 45° (± 3°) by adjusting ship speed and course. After reaching the surface, the nets were washed down and the samples preserved in 5% formalin buffered with sodium borate. At the beginning and end of each tow, readings were made from a flow meter suspended in the mouth of the starboard net. Detailed descriptions of gear and methods are given by Kramer et al. (1972) and Smith and Richardson (1977); Ohman and Smith (1995) provided summaries of historical CalCOFI zooplankton methods and calibration factors for the various gear types.

LABORATORY PROCEDURES

The ichthyoplankton was removed from the invertebrate portion of each sample and bottled separately in 3% buffered formalin. In addition to fish eggs and larvae, some samples contained juvenile, and occasionally adult, stages of fishes; these were removed and bottled separately in 3% formalin. The volume of water filtered by each net was computed from the flowmeter readings. A "standard haul factor" is used for oblique CalCOFI net tows to calculate the total number of ichthyoplankters of a taxon per unit surface area (Kramer et al. 1972; Smith and Richardson 1977; Moser et al. 1993). A requirement for this is the entire depth distribution of the taxon must be encompassed during the tow. The Manta net samples only the upper ~15.5 cm of the water column and most, if not all, ichthyoplankton taxa that inhabit the surface zone have a vertical range > 15.5 cm. Even taxa associated with the immediate surface layer may range deeper than 15.5 cm as a result of diel migratory patterns or vertical mixing (Hempel and Weikert 1972; Doyle 1992b).

Calculation of total numbers of eggs or larvae per unit surface area from Manta net samples awaits accurate information on the fine-scale vertical distribution of these organisms in the upper region of the water column. Even if there are few species whose larvae are restricted to the upper 15.5 cm of the water column, the time series of Manta samples provides a useful index of relative abundance for species whose larvae appear in these samples. In this report we express quantities of eggs or larvae in each sample as unadjusted counts or as numbers of eggs or larvae per unit volume of water filtered by the Manta net.

We determined a zooplankton displacement volume for each Bongo net sample (methods described in Staff, SPFI 1953 and Kramer et al. 1972). Samples containing > 25 ml of plankton were fractionated to ~50% of their original volume (Manta net samples are not fractionated). Aliquot percentages for fractionated samples are listed in Table 5 under the "Percent Sorted" column. The sorting process included the removal of all ichthyoplankton from the samples and identification and separation of: eggs and larvae of Pacific sardine, northern anchovy, and Pacific saury and larvae of Pacific hake. Body lengths of sardine, anchovy, and hake larvae were measured to the nearest 0.5 mm.

A standard haul factor (SHF) was calculated for each Bongo net tow to make them comparable and to allow estimation of areal abundance. The SHF is calculated by the formula:

$$\text{SHF} = \frac{10 D}{V}$$

where D = depth of haul = cosine of the average angle of stray of the towing cable multiplied by cable length (m)

V = total volume of water (m³) strained during the haul

$$V = R \cdot a \cdot p$$

where R = total number of revolutions of the current meter during the haul

a = area (m²) of the mouth of the net

p = length of the column of water needed produce one revolution of the current meter

Tow depth, volume of water strained, and standard haul factor are listed in Table 5 for each tow taken during the 1997–1998 Mini-CalCOFI survey. Detailed descriptions of factors involved in calculating these values are presented in Ahlstrom (1948), Kramer et al. (1972), and Smith and Richardson (1977).

IDENTIFICATION

Identification of ichthyoplankton species beyond those separated during the sorting process was done by a separate group of specialists. Early ontogenetic stages of fishes are inherently difficult to identify and this is further complicated by the large number and diversity of species which contribute to the ichthyoplankton of the California Current region. Most identifications were accomplished by establishing ontogenetic series on the basis of morphology, meristics, and pigmentation, and then linking these series through overlapping features to known metamorphic, juvenile, or adult stages (Powles and Markle 1984). Our ability to identify larvae in the California Current region improved greatly during 1988–1995 as a result of an intensive research project aimed at producing a taxonomic monograph on the ontogenetic stages of fishes of this region (Moser 1996). Except for damaged specimens, most larvae in the 1997–1998 Mini-

CalCOFI survey could be identified to species. A total of 37 larval fish taxa was identified in Manta net tows for 1997–1998: 32 to species and 5 to genus. A total of 108 larval fish categories (including disintegrated) was identified in the Bongo net tows: 92 to species, 13 to genus, and 2 to family. Identifications were done in the Ichthyoplankton Ecology Laboratory of the Fisheries Resources Division.

With few exceptions, taxonomic categories above species represent small specimens which were damaged and partly disintegrated during capture. The following taxonomic categories in Tables 2–4 and 6–8 require special explanation:

Citharichthys spp. – small or damaged larvae, probably *C. sordidus* and/or *C. stigmaeus* lacking diagnostic characters.

Diaphus spp. – *Diaphus theta* is the dominant *Diaphus* species in the survey area and most, if not all, of the larvae from the Southern California Bight region are this species; the generic category is used because a small proportion of the *Diaphus* larvae captured at the outer margin of the survey pattern may represent other species whose larvae are identical to those of *D. theta*.

Disintegrated fish larvae – larvae that could not be identified because of their poor condition; separated from the "unidentified" category to monitor the general condition of the ichthyoplankton samples through the time series.

Howella spp. – larvae represent a single species, either *H. brodiei* or *H. sherborni*; taxonomy of the adult is unresolved.

Nannobranchium – Zahuranec (2000) moved the subgroup of *Lampanyctus* characterized by small or absent pectoral fins in adults to the genus *Nannobranchium*; two *Nannobranchium* species, *N. ritteri* (formerly *L. ritteri*) and *N. regale* (formerly *L. regalis*), occur commonly in the present CalCOFI survey pattern; larvae of these species > ~ 5 mm have been identified in oblique tow samples since 1954; beginning in 1985, larvae of two other species, *N. bristori* and *N. hawaiiensis*, have been identified and included in the CalCOFI data base; in previous data reports these were referred to as *Lampanyctus* "niger" and *Lampanyctus* "no pectorals", respectively (see Moser 1996).

Lyopsetta exilis – see comment for Pleuronectidae.

Melamphaes spp. – small or damaged larvae, mostly *M. lugubris* and/or *M. parvus* lacking diagnostic characters.

Microstoma spp. – larvae of a distinct but undescribed microstomatid species.

Pleuronectidae – Sakamoto (1984) changed pleuronectid generic designations for species in the CalCOFI area as follows: 1) *Glyptocephalus zachirus* was changed to *Errex zachirus*; 2) *Isopsetta isolepis*, *Lepidopsetta bilineata*, and *Parophrys vetulus* were transferred into *Pleuronectes* and 3) *Lyopsetta exilis* was changed to *Eopsetta exilis*; although these changes were incorporated in the lists of Robins et al. (1991) and Eschmeyer (1998) we follow Nelson (1994) in retaining the older nomenclature because Sakamoto's (1984) changes were based on a phenetic study; also, the older names are used in the major identification guides to fishes of our region (Miller and Lea 1972, Eschmeyer et al. 1983, Matarese et al. 1989, and Moser 1996).

Scopelosaurus spp.— according to Balanov and Savinykh (1999) there are two valid species of this genus in the north Pacific, *S. adleri* and *S. harryi*, but only the former spawns in the California Current region; the generic designation is used here since we have not yet reexamined the historical CalCOFI samples to confirm the findings of Balanov and Savinykh (1999).

Vinciguerria lucetia – *V. lucetia*, an eastern tropical Pacific species, is common in the present CalCOFI region whereas the central water mass species *V. poweriae* is encountered rarely, usually only at the most seaward CalCOFI stations; a small percentage of *V. poweriae* larvae may have been included in the *V. lucetia* category because of the difficulty in separating early larvae which often are virtually identical.

SPECIES SUMMARY

Of the five most abundant larvae collected in Manta net tows on Mini-CalCOFI cruises in 1997–1998, northern anchovy (*Engraulis mordax*) ranked first in abundance with 33.7% of the total fish larvae and second in occurrence with larvae collected in 24.4% of the total samples (Tables 2 and 3). The second most abundant species was Pacific sardine (*Sardinops sagax*), which accounted for 26.1% of the total larvae and ranked fourth in occurrence (9.2% of the samples). Mussel blenny (*Hypsoblennius jenkinsi*) was the third most abundant with 15.2% of the total larvae and also ranked third in frequency of occurrence (11.8% of the samples). Pacific saury (*Cololabis saira*) ranked fourth in abundance with 13.4% of total larvae and first in total occurrence (39.5% of the samples). California grunion (*Leuresthes tenuis*) ranked fifth in abundance (1.9% of the total larvae) and tied for fifth in occurrence (5.0% of the samples). The next six most abundant taxa were blacksmith *Chromis punctipinnis*, the blenny genus *Hypsoblennius* spp., and the rockfish genus *Sebastes* (tied with 0.9% of total larvae), jacksmelt *Atherinopsis californiensis* (0.8%), and jack mackerel *Trachurus symmetricus* and opaleye *Girella nigricans* (tied with 0.7%). These taxa ranked tied for 7th, tied for 10th, tied for 7th, tied for 13th, tied for 10th, and tied for 13th in frequency of occurrence, respectively. The eleven most abundant taxa comprised 95.3% of all the larvae collected in Manta net tows on Mini-CalCOFI cruises in 1997–1998. The remaining 4.7% was distributed among 26 other taxa. Of the eleven most abundant taxa, three were coastal demersal taxa, three were coastal pelagic species, one was epipelagic, and four were nearshore schooling species.

Of the five most abundant larvae collected in Bongo net tows on the 1997–1998 Mini-CalCOFI survey, Panama lightfish (*Vinciguerria lucetia*) ranked first in abundance, with 45.3% of the total larvae, and second in occurrence, with 34.5% positive tows (Tables 6 and 7). It was more than four times as abundant as the second most abundant species, northern anchovy (*E. mordax*), which accounted for 9.3% of the total larvae, and ranked first in occurrence (35.4% of the samples). Pacific sardine (*S. sagax*) ranked third with 6.4% of the larvae and tied for 18th in occurrence (9.7% of the stations). Mexican lampfish (*Triphoturus mexicanus*) ranked fourth in abundance with 3.9% of the total larvae and tied for second in frequency of occurrence with 34.5% positive tows. Snubnose blacksmelt (*Bathylagus wesethi*) ranked fifth in abundance (3.6% of total larvae) and tied for ninth in occurrence (19.5% positive tows). The next five most abundant taxa were dogtooth lampfish *Ceratoscopelus townsendi* (3.2% of total larvae), the rockfish genus *Sebastes* (3.0%), California smoothtongue *Leuroglossus stilbius* (2.3%), longfin lanternfish *Diogenichthys atlanticus* (2.1%), and northern lampfish *Stenobranchius leucopsarus* (2.0%). These species ranked 8th, 7th, 12th, tied for 5th, and tied for 9th in frequency of occurrence, respectively. The ten most abundant taxa comprised 81.1% of all the larvae collected in Bongo net tows on Mini-CalCOFI cruises in 1997–1998. The remaining 18.9% was distributed among 98 other taxa (including the disintegrated category). Of the ten most abundant taxa, seven were midwater species, two were coastal pelagic species, and one was coastal demersal taxon.

EXPLANATION OF TABLES

- Table 1. This table lists for each tow the pertinent station and tow data, the volume of water filtered, and the total number of fish eggs and larvae for Manta net tow stations occupied during the 1997–1998 Mini-CalCOFI survey. Cruises are designated by a four digit code; the first two digits indicate the year and the second two the month. Within each cruise the data are listed in order of increasing line and station number (southerly and seaward directions); the order of station occupancy is shown on the station charts (Figures 2–5). Stations are designated by two groups of numbers; the first set indicates the line and decimal fraction and the second set indicates the station and decimal fraction. Time is listed as Pacific Standard Time at the start of each tow in 24-hour designation. The values for total fish eggs and larvae are raw counts (unadjusted for volume of water filtered). The listings for station latitude and longitude in this table may differ from values given for the same station in the SIO data reports, reflecting the slight difference in position of the net tow and hydrocast.
- Table 2. Pooled occurrences of all larval fish taxa taken in Manta nets during the 1997–1998 Mini-CalCOFI survey. Taxa are listed in rank order.
- Table 3. Pooled counts (unadjusted for volume of water filtered) of all larval fish taxa taken in Manta net tows during the 1997–1998 Mini-CalCOFI. Taxa are listed in rank order.
- Table 4. Numbers of fish larvae for each taxon taken in Manta net tows during the 1997–1998 Mini-CalCOFI survey. Numbers of larvae are listed as number per 100 m³ of water filtered. Orders and families are listed in phylogenetic sequence (Eschmeyer 1998); other taxa are listed alphabetically.
- Table 5. This table lists for each Bongo net tow the pertinent station and tow data, the volume of water filtered, the standard haul factor, the plankton volume, the percentage of sample sorted, and the total number of fish eggs and larvae during the 1997–1998 Mini-CalCOFI. Cruises are designated by four digits; the first two indicate the year and the second two the month. Within each cruise the data are listed in order of increasing line and station number (southerly and seaward directions); the order of station occupancy is shown on the station charts (Figures 2–5). Stations are designated by two groups of numbers; the first set indicates the line and decimal fraction and the second set indicates the station and decimal fraction. Plankton displacement volumes were determined after removal of large organisms (those with individual displacement volumes > 5 ml) and expressed as ml per 1000 m³ of water filtered. Time is listed as Pacific Standard Time at the start of each tow in 24-hour designation. The values for total fish eggs and larvae are raw counts (unadjusted for percent of sample sorted or standard haul factor). The listings for station latitude and longitude in this table may differ from values given for the same station in the SIO data reports, reflecting the slight difference in position of the net tow and hydrocast. Dates given here and in Figures 2–5 for the beginning and end of each cruise are based on Pacific Standard time at the first and last oblique net tow station of the cruise and do not include transit time from port to the first station and to port after the last station. Thus, our cruise dates may differ slightly from those in SIO reports which are based on GMT prior to 1990 and include transit time to the first station and from the last station.
- Table 6. Pooled occurrences of all larval fish taxa taken in Bongo net tows on the 1997–1998 Mini-CalCOFI survey cruises in listed in rank order.
- Table 7. Pooled counts of all larval fish taxa taken in Bongo net tows on the 1997–1998 Mini-CalCOFI survey cruises listed in rank order. Numbers are adjusted for percent sorted and standard haul factors.

Table 8. Numbers of fish larvae for each taxon, listed by station and calendar month of the Bongo net tow. Counts are adjusted for percentage of sample sorted and standard haul factor. The orders and families are listed in phylogenetic sequence (Eschmeyer 1998); other taxa are listed alphabetically.

ACKNOWLEDGMENTS

The following NMFS personnel were responsible for making the collections at sea: Ronald Dotson (9806, 9812), David Griffith (9803, 9811), Amy Hays (all cruises, except 9806), Daryl Swensen (all cruises, except 9712), and Ginger Toschiaddi (9810). The samples were sorted by Lucy Dunn. Amy Hays edited the field data. Susan Manion entered the data and assisted with the figures and tables. The cooperation and assistance provided by the crew of the RV *Robert Gordon Sproul* were instrumental in making the collections and observations at sea.

LITERATURE CITED

- Ahlstrom, E. H. 1948. A record of pilchard eggs and larvae collected during surveys made in 1939 to 1941. U.S. Wildl. Serv. Spec. Sci. Rep. Fish. SSRF-54. 82 pp.
- Ahlstrom, E. H. and E. G. Stevens. 1976. Report of neuston (surface) collections made on an extended CalCOFI cruise during May 1972. Calif. Coop. Oceanic Fish. Invest. Rep. 18:167–180.
- Ambrose, D. A., R. L. Charter, H. G. Moser, and C. R. Santos Methot. 1987a. Ichthyoplankton and station data for California Cooperative Oceanic Fisheries Investigations survey cruises in 1951. U.S. Dep. Commer., NOAA Tech. Memo., NOAA-TM-NMFS-SWFC-79. 196 pp.
- Ambrose, D. A., R. L. Charter, H. G. Moser, and C. R. Santos Methot. 1987b. Ichthyoplankton and station data for California Cooperative Oceanic Fisheries Investigations survey cruises in 1955. U.S. Dep. Commer., NOAA Tech. Memo., NOAA-TM-NMFS-SWFC-83. 185 pp.
- Ambrose, D. A., R. L. Charter, H. G. Moser, and C. R. Santos Methot. 1987c. Ichthyoplankton and station data for California Cooperative Oceanic Fisheries Investigations survey cruises in 1960. U.S. Dep. Commer., NOAA Tech. Memo., NOAA-TM-NMFS-SWFC-88. 253 pp.
- Ambrose, D. A., R. L. Charter, H. G. Moser, and B. S. Earhart. 1988a. Ichthyoplankton and station data for California Cooperative Oceanic Fisheries Investigations survey cruises in 1963. U.S. Dep. Commer., NOAA Tech. Memo., NOAA-TM-NMFS-SWFC-94. 209 pp.
- Ambrose, D. A., R. L. Charter, H. G. Moser, and B. S. Earhart. 1988b. Ichthyoplankton and station data for California Cooperative Oceanic Fisheries Investigations survey cruises in 1967. U.S. Dep. Commer., NOAA Tech. Memo., NOAA-TM-NMFS-SWFC-98. 103 pp.
- Ambrose, D. A., R. L. Charter, H. G. Moser, and B. S. Earhart. 1988c. Ichthyoplankton and station data for California Cooperative Oceanic Fisheries Investigations survey cruises in 1975. U.S. Dep. Commer., NOAA Tech. Memo., NOAA-TM-NMFS-SWFC-110. 221 pp.
- Ambrose, D. A., R. L. Charter, H. G. Moser, and B. S. Earhart. 1988d. Ichthyoplankton and station data for California Cooperative Oceanic Fisheries Investigations survey cruises in 1981. U.S. Dep. Commer., NOAA Tech. Memo., NOAA-TM-NMFS-SWFC-112. 170 pp.

- Ambrose, D. A., R. L. Charter, and H. G. Moser. 1999a. Ichthyoplankton and station data for California Cooperative Oceanic Fisheries Investigations survey cruises in 1985. U.S. Dep. Commer., NOAA Tech. Memo., NOAA-TM-NMFS-SWFSC-266. 79 pp.
- Ambrose, D. A., R. L. Charter, and H. G. Moser. 1999b. Ichthyoplankton and station data for California Cooperative Oceanic Fisheries Investigations survey cruises in 1989. U.S. Dep. Commer., NOAA Tech. Memo., NOAA-TM-NMFS-SWFSC-270. 87 pp.
- Ambrose, D. A., R. L. Charter, and H. G. Moser. 1999c. Ichthyoplankton and station data for California Cooperative Oceanic Fisheries Investigations survey cruises in 1993. U.S. Dep. Commer., NOAA Tech. Memo., NOAA-TM-NMFS-SWFSC-274. 88 pp.
- Ambrose, D. A., R. L. Charter, and H. G. Moser. 1999d. Ichthyoplankton and station data for California Cooperative Oceanic Fisheries Investigations survey cruises in 1997. U.S. Dep. Commer., NOAA Tech. Memo., NOAA-TM-NMFS-SWFSC-278. 86 pp.
- Ambrose, D. A., R. L. Charter, and H. G. Moser. 2002a. Ichthyoplankton and station data for Manta (surface) tows taken on California Cooperative Oceanic Fisheries Investigations survey cruises in 1980-81. U.S. Dep. Commer., NOAA Tech. Memo. NOAA-TM-NMFS-SWFSC-319. 100 pp.
- Ambrose, D. A., R. L. Charter, and H. G. Moser. 2002b. Ichthyoplankton and station data for Manta (surface) tows taken on California Cooperative Oceanic Fisheries Investigations survey cruises in 1985. U.S. Dep. Commer., NOAA Tech. Memo. NOAA-TM-NMFS-SWFSC-321. 36 pp.
- Ambrose, D. A., R. L. Charter, and H. G. Moser. 2002c. Ichthyoplankton and station data for Manta (surface) tows taken on California Cooperative Oceanic Fisheries Investigations survey cruises in 1989. U.S. Dep. Commer., NOAA Tech. Memo. NOAA-TM-NMFS-SWFSC-325. 45 pp.
- Ambrose, D. A., R. L. Charter, and H. G. Moser. 2002d. Ichthyoplankton and station data for Manta (surface) tows taken on California Cooperative Oceanic Fisheries Investigations survey cruises in 1993. U.S. Dep. Commer., NOAA Tech. Memo. NOAA-TM-NMFS-SWFSC-329. 41 pp.
- Ambrose, D. A., R. L. Charter, and H. G. Moser. 2002e. Ichthyoplankton and station data for Manta (surface) tows taken on California Cooperative Oceanic Fisheries Investigations survey cruises in 1997. U.S. Dep. Commer., NOAA Tech. Memo. NOAA-TM-NMFS-SWFSC-333. 41 pp.
- Ambrose, D. A., R. L. Charter, and H. G. Moser. 2002f. Ichthyoplankton and station data for Manta (surface) tows taken on California Cooperative Oceanic Fisheries Investigations survey cruises in 1998. U.S. Dep. Commer., NOAA Tech. Memo. NOAA-TM-NMFS-SWFSC-334. 43 pp.
- Ambrose, D. A., R. L. Charter, and H. G. Moser. 2002g. Ichthyoplankton and station data for Manta (surface) tows taken on California Cooperative Oceanic Fisheries Investigations survey cruises in 1999. U.S. Dep. Commer., NOAA Tech. Memo. NOAA-TM-NMFS-SWFSC-335. 39 pp.
- Ambrose, D. A., R. L. Charter, and H. G. Moser. 2003. Ichthyoplankton and station data for Manta (surface) and oblique (Bongo) plankton tows for California Cooperative Oceanic Fisheries Investigations survey cruises in 2001. U.S. Dep. Commer., NOAA Tech. Memo. NOAA-TM-NMFS-SWFSC-348. 104 pp.

- Balanov, A. A. and V. F. Savinykh. 1999. Redescriptions of *Scopelosaurus harryi* and *S. adleri* (Notosudidae): two valid mesopelagic species inhabiting the northern part of the Pacific Ocean. *J. Ichthyol.* 39 (8):616–625.
- Banse, K. 1975. Pleuston and neuston: on the categories of organisms in the uppermost pelagial. *Int.Rev. ges. Hydrobiol.* 60(4):439–447.
- Brown, D. M. and L. Cheng. 1981. New net for sampling the ocean surface. *Mar. Ecol. Prog. Ser.* 5:224–227.
- Charter, S. R., R. L. Charter, and H. G. Moser. 1999a. Ichthyoplankton and station data for California Cooperative Oceanic Fisheries Investigations survey cruises in 1986. U.S. Dep. Commer., NOAA Tech. Memo., NOAA-TM-NMFS-SWFSC-267. 79 pp.
- Charter, S. R., R. L. Charter, and H. G. Moser. 1999b. Ichthyoplankton and station data for California Cooperative Oceanic Fisheries Investigations survey cruises in 1990. U.S. Dep. Commer., NOAA Tech. Memo., NOAA-TM-NMFS-SWFSC-271. 86 pp.
- Charter, S. R., R. L. Charter, and H. G. Moser. 1999c. Ichthyoplankton and station data for California Cooperative Oceanic Fisheries Investigations survey cruises in 1994. U. S. Dep. Commer., NOAA Tech. Memo., NOAA-TM-NMFS-SWFSC-275. 89 pp.
- Charter, S. R., R. L. Charter, and H. G. Moser. 1999d. Ichthyoplankton and station data for California Cooperative Oceanic Fisheries Investigations survey cruises in 1998. U. S. Dep. Commer., NOAA Tech. Memo., NOAA-TM-NMFS-SWFSC-279. 104 pp.
- Charter, S. R., R. L. Charter, and H. G. Moser. 2002a. Ichthyoplankton and station data for Manta (surface) tows taken on California Cooperative Oceanic Fisheries Investigations survey cruises in 1984. U.S. Dep. Commer., NOAA Tech. Memo. NOAA-TM-NMFS-SWFSC-320. 84 pp.
- Charter, S. R., R. L. Charter, and H. G. Moser. 2002b. Ichthyoplankton and station data for Manta (surface) tows taken on California Cooperative Oceanic Fisheries Investigations survey cruises in 1986. U.S. Dep. Commer., NOAA Tech. Memo. NOAA-TM-NMFS-SWFSC-322. 40 pp.
- Charter, S. R., R. L. Charter, and H. G. Moser. 2002c. Ichthyoplankton and station data for Manta (surface) tows taken on California Cooperative Oceanic Fisheries Investigations survey cruises in 1990. U.S. Dep. Commer., NOAA Tech. Memo. NOAA-TM-NMFS-SWFSC-326. 41 pp.
- Charter, S. R., R. L. Charter, and H. G. Moser. 2002d. Ichthyoplankton and station data for Manta (surface) tows taken on California Cooperative Oceanic Fisheries Investigations survey cruises in 1994. U.S. Dep. Commer., NOAA Tech. Memo. NOAA-TM-NMFS-SWFSC-330. 40 pp.
- Doyle, M. J. 1992a. Patterns in distribution and abundance of ichthyoplankton off Washington, Oregon, and northern California (1980–1987). U.S. Dep. Commer., Nat. Mar. Fish. Serv., Alaska Fish. Sci. Ctr. Proc. Rep. 92-14. 344 pp.
- Doyle, M. J. 1992b. Neustonic ichthyoplankton in the northern region of the California Current ecosystem. *Calif. Coop. Oceanic Fish. Invest. Rep.* 33:141–161.

- Eschmeyer, W. N. (ed.). 1998. Catalog of fishes. Center for Biodiversity Research and Information. California Academy of Sciences. Spec. Publ. 1. Vols. I-III. 2905 pp.
- Eschmeyer, W. N., E. S. Herald, and H. Hammann. 1983. A field guide to Pacific coast fishes of North America. Houghton Mifflin Co. Boston. 336 pp.
- Gruber, D., E. H. Ahlstrom, and M. M. Mullin. 1982. Distribution of ichthyoplankton in the Southern California Bight. Calif. Coop. Oceanic Fish. Invest. Rep. 23:172-179.
- Hempel, G. and H. Weikert. 1972. The neuston of the subtropical and boreal northeastern Atlantic Ocean. A review. Mar. Biol. 13:70-88.
- Hewitt, R. P. 1988. Historical review of the oceanographic approach to fishery research. Calif. Coop. Oceanic Fish. Invest. Rep. 29:27-41.
- Kramer, D., M. Kalin, E. G. Stevens, J. R. Thrailkill, and J. R. Zweifel. 1972. Collecting and processing data on fish eggs and larvae in the California Current Region. NOAA Tech. Rep. NMFS Circ. 370. 38 pp.
- Matarese, A. C., A. W. Kendall, Jr., D. M. Blood, and B. M. Vinter. 1989. Laboratory guide to early life history stages of northeast Pacific fishes. U.S. Dep. Commer., NOAA Tech. Rep. NMFS 80. 652 pp.
- McGowan, J. S. and D. M. Brown. 1966. A new opening-closing paired zooplankton net. Scripps Inst. Oceanogr. Ref. 66-23. 23 pp.
- Miller, D. J. and R. N. Lea. 1972. Guide to the coastal marine fishes of California. Calif. Dep. Fish Game Fish Bull. 157. 235 pp.
- Moser, H. G. (ed.). 1996. The early stages of fishes in the California Current region. CalCOFI Atlas 33. 1505 pp.
- Moser, H. G., R. L. Charter, P. E. Smith, D. A. Ambrose, S. R. Charter, C. A. Meyer, E. M. Sandknop, and W. Watson. 1993. Distributional atlas of fish larvae and eggs in the California Current region: taxa with 1000 or more total larvae, 1951 through 1984. CalCOFI Atlas 31. 233 pp.
- Moser, H. G., R. L. Charter, P. E. Smith, D. A. Ambrose, S. R. Charter, C. A. Meyer, E. M. Sandknop, and W. Watson. 1994. Distributional atlas of fish larvae in the California Current region: taxa with less than 1000 total larvae, 1951 through 1984. CalCOFI Atlas 32. 181 pp.
- Moser, H. G., R. L. Charter, P. E. Smith, D. A. Ambrose, W. Watson, S. R. Charter, and E. M. Sandknop. 2001a. Distributional atlas of fish larvae and eggs in the Southern California Bight region: 1951-1998. CalCOFI Atlas 34. 166 pp.
- Moser, H. G., R. L. Charter, D. A. Ambrose, and E. M. Sandknop. 2001b. Ichthyoplankton and station data for Manta (surface) tows taken on California Cooperative Oceanic Fisheries Investigations survey cruises in 1977-78. U.S. Dep. Commer., NOAA Tech. Memo. NOAA-TM-NMFS-SWFSC-313. 58 pp.

- Moser, H. G., R. L. Charter, P.E. Smith, D. A. Ambrose, W. Watson, S. R. Charter, and E. M. Sandknop. 2002. Distributional atlas of fish larvae and eggs from Manta (surface) samples collected on CalCOFI surveys from 1977 to 2000. *CalCOFI Atlas* 35. 97 pp.
- Naumann, E. 1917. Beiträge zur Kenntnis des Teichnannoplanktons. II. Über das Neuston das Süßwassers. *Biol. Zentralbl.* 37:98–106.
- Nelson, J. S. 1994. *Fishes of the world*. Third edition. John Wiley and Sons, N.Y. 600 pp.
- Ohman, M. D. and P. E. Smith. 1995. A comparison of zooplankton sampling methods in the CalCOFI time series. *Calif. Coop. Oceanic Fish. Invest. Rep.* 36:153-158.
- Peres, J. M. 1982. Specific pelagic assemblages: 1. Assemblages at the air-ocean interface *In Marine Ecology*. O. Kinne (ed.). 5 (1):313–372.
- Powles, H. and D. F. Markle. 1984. Identification of larvae. Pages 31-33 *in* H. G. Moser, W. J. Richards, D. M. Cohen, M. P. Fahay, A. W. Kendall, Jr., and S. L. Richardson, eds. *Ontogeny and Systematics of Fishes*. Am. Soc. Ichthyol. Herpetol. Spec. Publ. 1. 760 pp.
- Robins, C. R., R. M. Bailey, C. E. Bond, J. R. Brooker, E. A. Lachner, R. N. Lea, and W. B. Scott. 1991. *Common and scientific names of fishes from the United States and Canada*. Fifth edition. Am. Fish. Soc. Spec. Publ. 20. 183 pp.
- Sakamoto, K. 1984. Interrelationships of the family Pleuronectidae (Pisces: Pleuronectiformes). *Mem. Fac. Fish. Hokkaido Univ.* 31:95-215.
- Sandknop, E. M., R. L. Charter, H. G. Moser, and J. D. Ryan. 1987a. Ichthyoplankton and station data for California Cooperative Oceanic Fisheries Investigations survey cruises in 1952. U.S. Dep. Commer., NOAA Tech. Memo., NOAA-TM-NMFS-SWFC-80. 207 pp.
- Sandknop, E. M., R. L. Charter, H. G. Moser, and J. D. Ryan. 1987b. Ichthyoplankton and station data for California Cooperative Oceanic Fisheries Investigations survey cruises in 1958. U.S. Dep. Commer. NOAA Tech. Memo., NOAA-TM-NMFS-SWFC-86. 248 pp.
- Sandknop, E. M., R. L. Charter, H. G. Moser, C. A. Meyer, and A. E. Hays. 1988a. Ichthyoplankton and station data for California Cooperative Oceanic Fisheries Investigations survey cruises in 1961. U.S. Dep. Commer., NOAA Tech. Memo., NOAA-TM-NMFS-SWFC-92. 167 pp.
- Sandknop, E. M., R. L. Charter, H. G. Moser, C. A. Meyer, and A. E. Hays. 1988b. Ichthyoplankton and station data for California Cooperative Oceanic Fisheries Investigations survey cruises in 1964. U.S. Dep. Commer., NOAA Tech. Memo., NOAA-TM-NMFS-SWFC-95. 222 pp.
- Sandknop, E. M., R. L. Charter, H. G. Moser, C. A. Meyer, and A. E. Hays. 1988c. Ichthyoplankton and station data for California Cooperative Oceanic Fisheries Investigations survey cruises in 1968. U.S. Dep. Commer., NOAA Tech. Memo., NOAA-TM-NMFS-SWFC-99. 112 pp.

- Sandknop, E. M., R. L. Charter, H. G. Moser, C. A. Meyer, and A. E. Hays. 1988d. Ichthyoplankton and station data for California Cooperative Oceanic Fisheries Investigations survey cruises in 1978. U.S. Dep. Commer., NOAA Tech. Memo., NOAA-TM-NMFS-SWFC-111. 216 pp.
- Sandknop, E. M., R. L. Charter, and H. G. Moser. 1999a. Ichthyoplankton and station data for California Cooperative Oceanic Fisheries Investigations survey cruises in 1987. U.S. Dep. Commer., NOAA Tech. Memo., NOAA-TM-NMFS-SWFSC-268. 91 pp.
- Sandknop, E. M., R. L. Charter, and H. G. Moser. 1999b. Ichthyoplankton and station data for California Cooperative Oceanic Fisheries Investigations survey cruises in 1991. U.S. Dep. Commer., NOAA Tech. Memo., NOAA-TM-NMFS-SWFSC-272. 90 pp.
- Sandknop, E. M., R. L. Charter, and H. G. Moser. 1999c. Ichthyoplankton and station data for California Cooperative Oceanic Fisheries Investigations survey cruises in 1995. U.S. Dep. Commer., NOAA Tech. Memo., NOAA-TM-NMFS-276. 84 pp.
- Sandknop, E. M., R. L. Charter, and H. G. Moser. 2002a. Ichthyoplankton and station data for Manta (surface) tows taken on California Cooperative Oceanic Fisheries Investigations survey cruises in 1987. U.S. Dep. Commer., NOAA Tech. Memo. NOAA-TM-NMFS-SWFSC-323. 40 pp.
- Sandknop, E. M., R. L. Charter, and H. G. Moser. 2002b. Ichthyoplankton and station data for Manta (surface) tows taken on California Cooperative Oceanic Fisheries Investigations survey cruises in 1991. U.S. Dep. Commer., NOAA Tech. Memo. NOAA-TM-NMFS-SWFSC-327. 41 pp.
- Sandknop, E. M., R. L. Charter, and H. G. Moser. 2002c. Ichthyoplankton and station data for Manta (surface) tows taken on California Cooperative Oceanic Fisheries Investigations survey cruises in 1995. U.S. Dep. Commer., NOAA Tech. Memo. NOAA-TM-NMFS-SWFSC-331. 42 pp.
- Smith, P. E. and S. L. Richardson. 1977. Standard techniques for pelagic fish egg and larva surveys. FAO Fish. Tech. Pap. 175. 100 pp.
- Staff, South Pacific Fisheries Investigations. 1953. Zooplankton volumes off the Pacific Coast, 1952. U.S. Fish. Wildl. Serv. Spec. Sci. Rep. Fish. SSRF-100. 41 pp.
- Stevens, E. G., R. L. Charter, H. G. Moser, and M. S. Busby. 1987a. Ichthyoplankton and station data for California Cooperative Oceanic Fisheries Investigations survey cruises in 1953. U.S. Dep. Commer., NOAA Tech. Memo., NOAA-TM-NMFS-SWFC-81. 186 pp.
- Stevens, E. G., R. L. Charter, H. G. Moser, and M. S. Busby. 1987b. Ichthyoplankton and station data for California Cooperative Oceanic Fisheries Investigations survey cruises in 1956. U.S. Dep. Commer., NOAA Tech. Memo., NOAA-TM-NMFS-SWFC-84. 189 pp.
- Stevens, E. G., R. L. Charter, H. G. Moser, and M. S. Busby. 1987c. Ichthyoplankton and station data for California Cooperative Oceanic Fisheries Investigations survey cruises in 1959. U.S. Dep. Commer., NOAA Tech. Memo., NOAA-TM-NMFS-SWFC-87. 273 pp.
- Stevens, E. G., R. L. Charter, H. G. Moser, and L. R. Zins. 1988a. Ichthyoplankton and station data for California Cooperative Oceanic Fisheries Investigations survey cruises in 1965. U.S. Dep. Commer., NOAA Tech. Memo., NOAA-TM-NMFS-SWFC-96. 220 pp.

- Stevens, E. G., R. L. Charter, H. G. Moser, and L. R. Zins. 1988b. Ichthyoplankton and station data for California Cooperative Oceanic Fisheries Investigations survey cruises in 1969. U.S. Dep. Commer., NOAA Tech. Memo., NOAA-TM-NMFS-SWFC-100. 265 pp.
- Stevens, E. G., R. L. Charter, H. G. Moser, and C. A. Meyer. 1990. Ichthyoplankton and station data for California Cooperative Oceanic Fisheries Investigations survey cruises in 1984. U.S. Dep. Commer., NOAA Tech. Memo., NOAA-TM-NMFS-SWFC-141. 157 pp.
- Sumida, B. Y., R. L. Charter, H. G. Moser, and D. L. Snow. 1987a. Ichthyoplankton and station data for California Cooperative Oceanic Fisheries Investigations survey cruises in 1954. U.S. Dep. Commer., NOAA Tech. Memo., NOAA-TM-NMFS-SWFC-82. 207 pp.
- Sumida, B. Y., R. L. Charter, H. G. Moser, and D. L. Snow. 1987b. Ichthyoplankton and station data for California Cooperative Oceanic Fisheries Investigations survey cruises in 1957. U.S. Dep. Commer., NOAA Tech. Memo., NOAA-TM-NMFS-SWFC-85. 225 pp.
- Sumida, B. Y., R. L. Charter, H. G. Moser, and D. L. Snow. 1988a. Ichthyoplankton and station data for California Cooperative Oceanic Fisheries Investigations survey cruises in 1962. U.S. Dep. Commer., NOAA Tech. Memo., NOAA-TM-NMFS-SWFC-93. 179 pp.
- Sumida, B. Y., R. L. Charter, H. G. Moser, and D. L. Snow. 1988b. Ichthyoplankton and station data for California Cooperative Oceanic Fisheries Investigations survey cruises in 1966. U.S. Dep. Commer., NOAA Tech. Memo., NOAA-TM-NMFS-SWFC-97. 287 pp.
- Sumida, B. Y., R. L. Charter, H. G. Moser, and D. L. Snow. 1988c. Ichthyoplankton and station data for California Cooperative Oceanic Fisheries Investigations survey cruises in 1972. U.S. Dep. Commer., NOAA Tech. Memo., NOAA-TM-NMFS-SWFC-109. 219 pp.
- University of California, Scripps Institution of Oceanography. 1999a. Data Report. Physical, chemical and biological data. CalCOFI Cruise 9707, 1–18 July 1997, CalCOFI Cruise 9709, 20 September–6 October 1997, CalCOFI Cruise 9712, 13–16 December 1997. SIO Ref. 99-5. 113 pp.
- University of California, Scripps Institution of Oceanography. 1999b. Data Report. Physical, chemical and biological data. CalCOFI Cruise 9802, 23 January–14 February 1998, CalCOFI Cruise 9803, 11–17 March 1998, CalCOFI Cruise 9804, 2–23 April 1998, CalCOFI Cruise 9805, 16–22 May 1998, CalCOFI Cruise 9806, 17–23 June 1998. SIO Ref. 99-9. 160 pp.
- University of California, Scripps Institution of Oceanography. 1999c. Data Report. Physical, chemical and biological data. CalCOFI Cruise 9807, 9–27 July 1998, CalCOFI Cruise 9808, 12–18 August 1998, CalCOFI Cruise 9809, 13 September–1 October 1998, CalCOFI Cruise 9810, 16–22 October 1998, CalCOFI Cruise 9811, 18–24 November 1998, CalCOFI Cruise 9812, 10–15 December 1998. SIO Ref. 99-18. 171 pp.
- Watson, W., R. L. Charter, and H. G. Moser. 1999a. Ichthyoplankton and station data for California Cooperative Oceanic Fisheries Investigations survey cruises in 1988. U. S. Dep. Commer., NOAA Tech. Memo., NOAA-TM-NMFS-SWFSC-269. 88 pp.

- Watson, W., R. L. Charter, and H. G. Moser. 1999b. Ichthyoplankton and station data for California Cooperative Oceanic Fisheries Investigations survey cruises in 1992. U.S. Dep. Commer., NOAA Tech. Memo., NOAA-TM-NMFS-SWFSC-273. 90 pp.
- Watson, W., R. L. Charter, and H. G. Moser. 1999c. Ichthyoplankton and station data for California Cooperative Oceanic Fisheries Investigations survey cruises in 1996. U.S. Dep. Commer., NOAA Tech. Memo., NOAA-TM-NMFS-SWFSC-277. 91 pp.
- Watson, W., R. L. Charter, and H. G. Moser. 2002a. Ichthyoplankton and station data for Manta (surface) tows taken on California Cooperative Oceanic Fisheries Investigations survey cruises in 1988. U.S. Dep. Commer., NOAA Tech. Memo. NOAA-TM-NMFS-SWFSC-324. 46 pp.
- Watson, W., R. L. Charter, and H. G. Moser. 2002b. Ichthyoplankton and station data for Manta (surface) tows taken on California Cooperative Oceanic Fisheries Investigations survey cruises in 1992. U.S. Dep. Commer., NOAA Tech. Memo. NOAA-TM-NMFS-SWFSC-328. 40 pp.
- Watson, W., R. L. Charter, and H. G. Moser. 2002c. Ichthyoplankton and station data for Manta (surface) tows taken on California Cooperative Oceanic Fisheries Investigations survey cruises in 1996. U.S. Dep. Commer., NOAA Tech. Memo. NOAA-TM-NMFS-SWFSC-332. 45 pp.
- Watson, W., R. L. Charter, and H. G. Moser. 2002d. Ichthyoplankton and station data for Manta (surface) tows taken on California Cooperative Oceanic Fisheries Investigations survey cruises in 2000. U.S. Dep. Commer., NOAA Tech. Memo. NOAA-TM-NMFS-SWFSC-336. 40 pp.
- Zahuranec, B. J. 2000. Zoogeography and systematics of the lanternfishes of the genus *Nannobranchium* (Lampanyctini: Myctophidae). *Smiths. Contrib. Zool.* 607. 69 pp.
- Zaitsev, Y. P. 1970. Marine neustonology. Naukova Dumka. Kiev. 264 pp. [In Russian]. [English transl.: 1971. *Israel Progr. Sci. Transl.* No. 5976. 207 pp.]

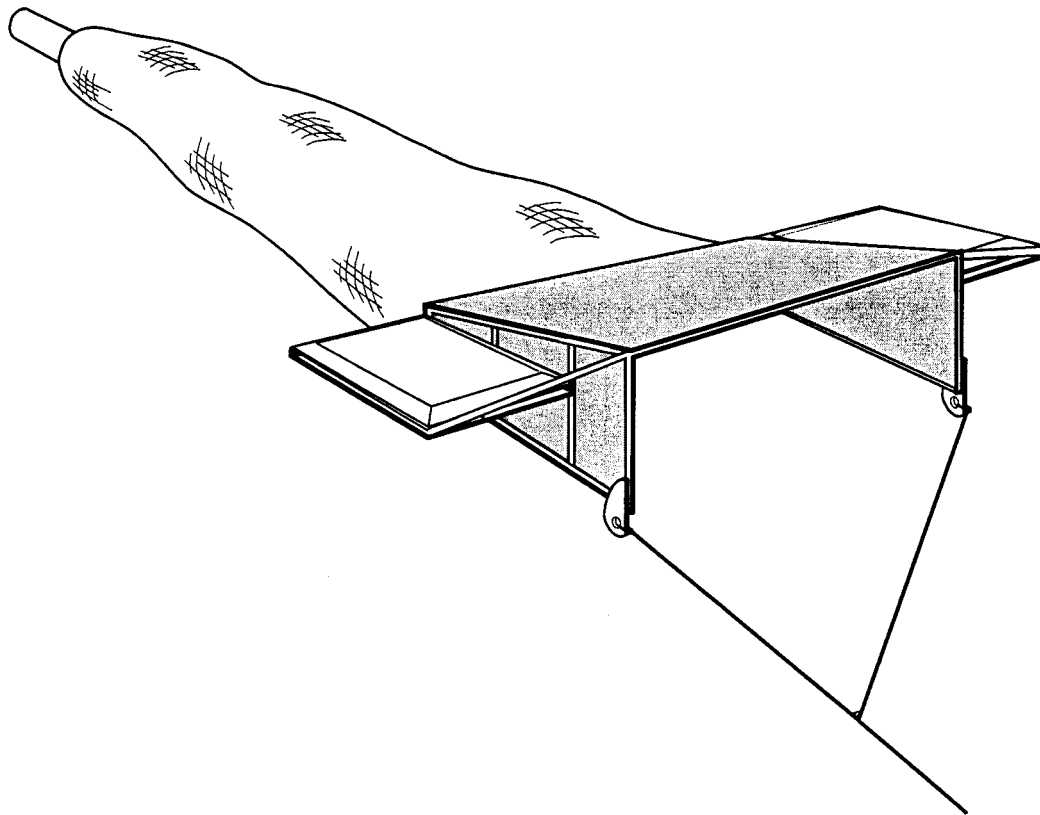

Figure 1. Diagram of the Manta net used on Mini-CalCOFI surveys.

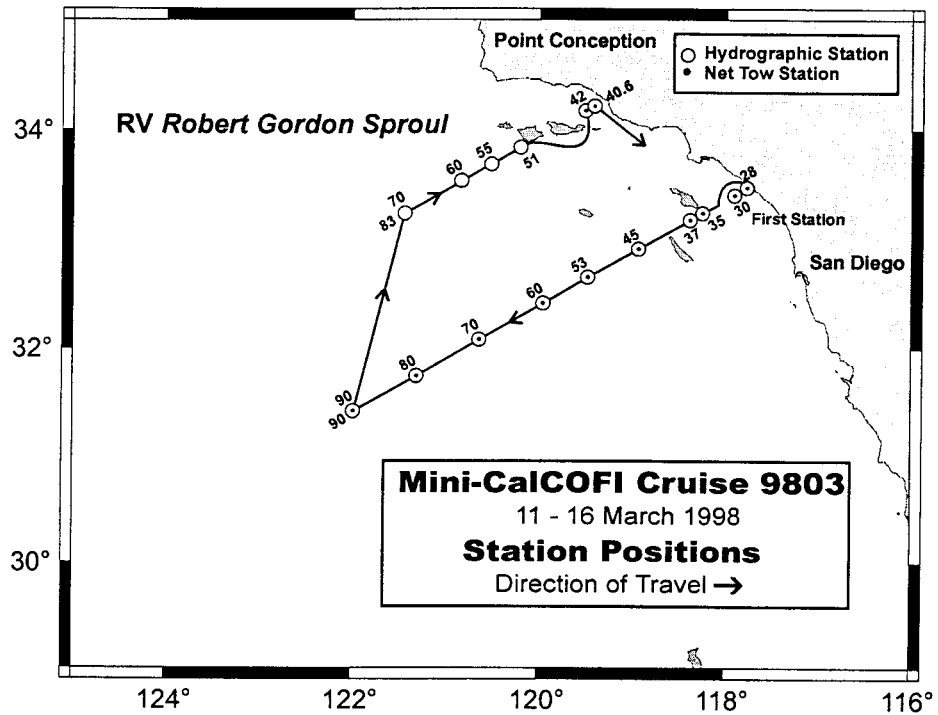
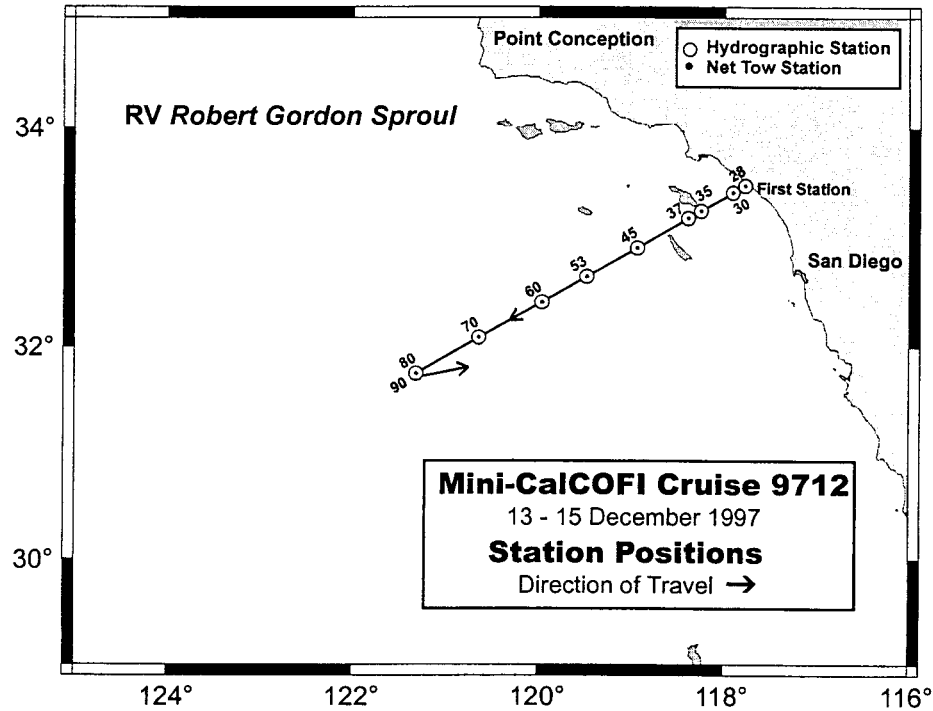

Figure 2. Stations and cruise tracks for Mini-CalCOFI Cruises 9712 (above) and 9803 (below). Circles indicate hydrographic stations; dots indicate net tow stations. A Manta tow without an accompanying oblique tow was taken on the following cruises and stations: 9712, 90.0 80.0 and 9803, 83.3 40.6. A Bongo tow without an accompanying surface tow was taken on Cruise 9803 at station 90.0 30.0.

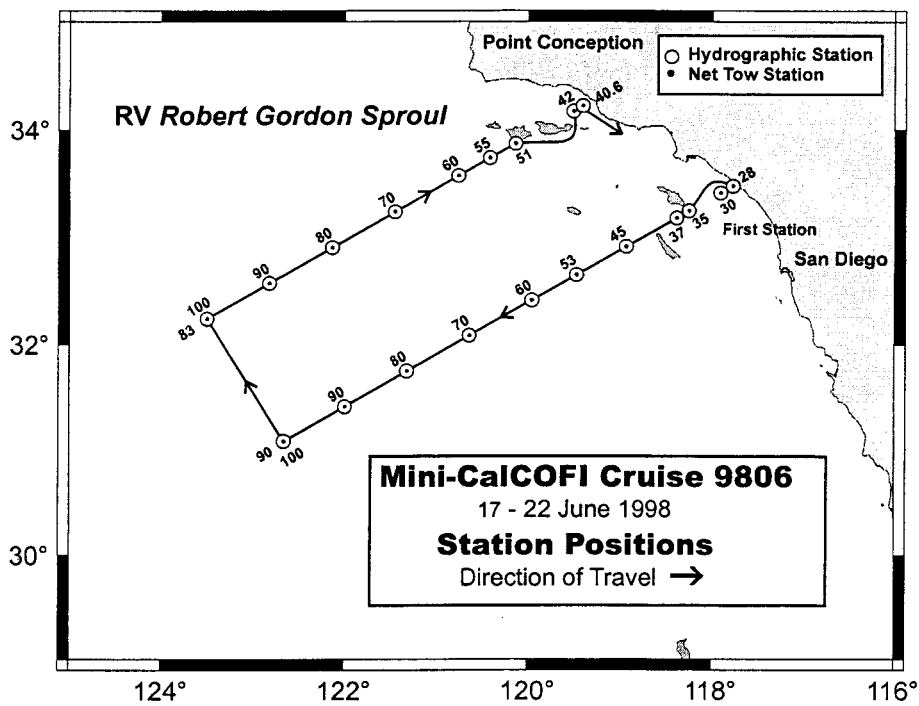
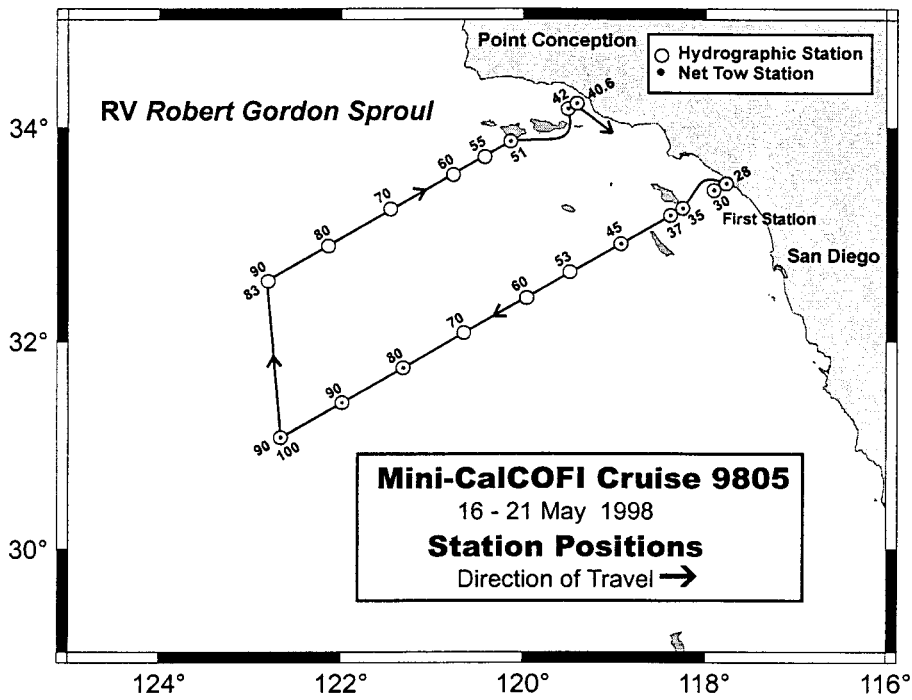

Figure 3. Stations and cruise tracks for Mini-CalCOFI Cruises 9805 (above) and 9806 (below). Symbols as in Figure 2. A Manta tow without an accompanying oblique tow was taken on Cruise 9805 at station 90.0 90.0.

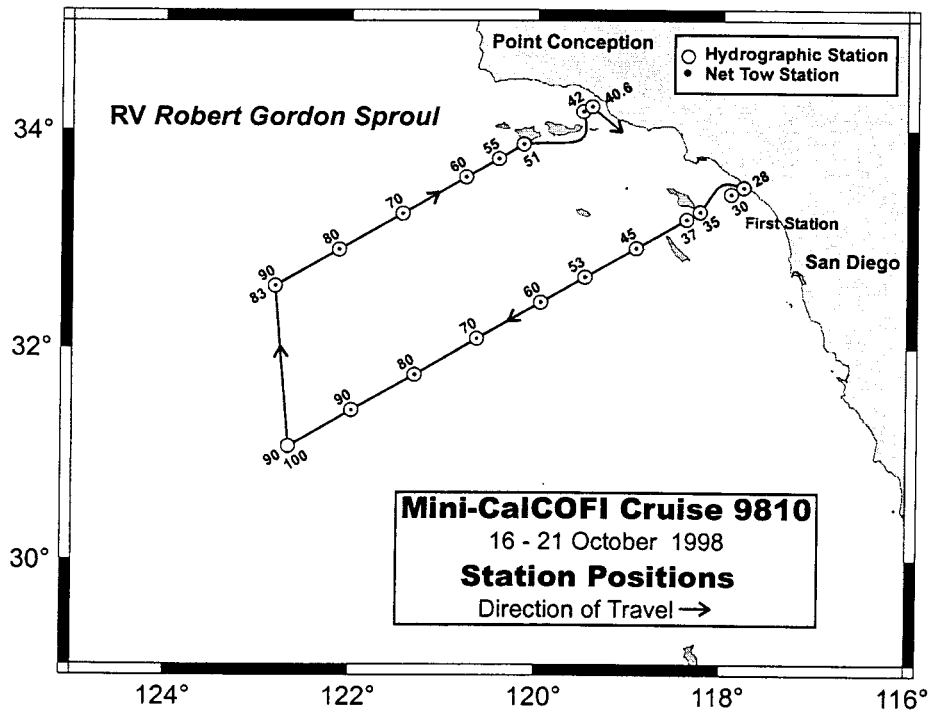
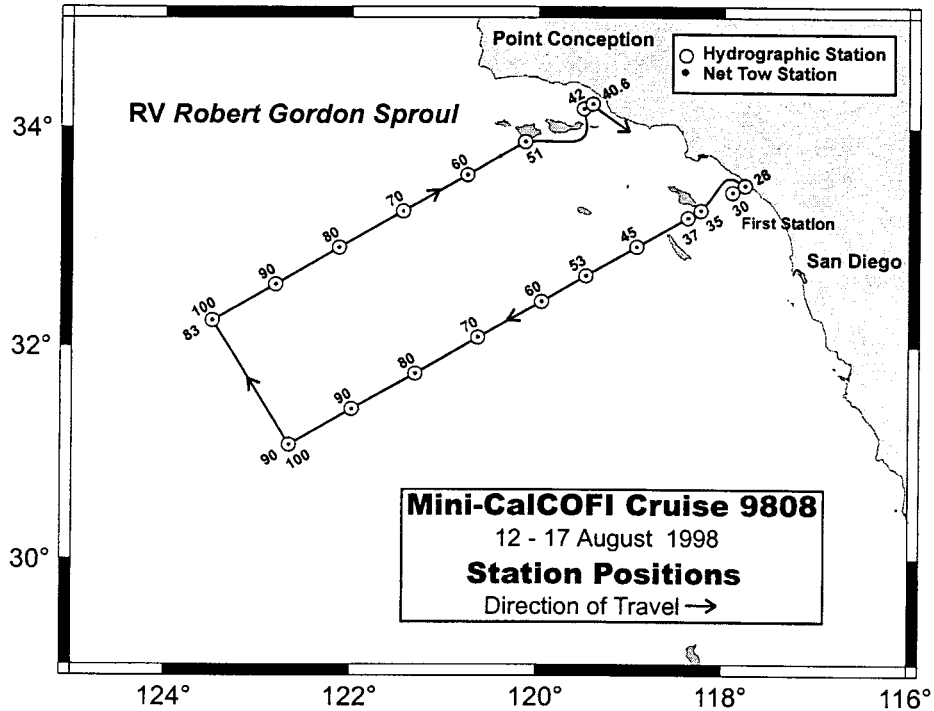

Figure 4. Stations and cruise tracks for Mini-CalCOFI Cruises 9808 (above) and 9810 (below). Symbols as in Figure 2. A Manta tow without an accompanying oblique tow was taken on the following cruises and stations: 9808, 83.3 70.0 and 90.0 45.0; 9810, 90.0 70.0 and 90.0 90.0. A Bongo tow without an accompanying surface tow was taken on Cruise 9808 at station 83.3 55.0.

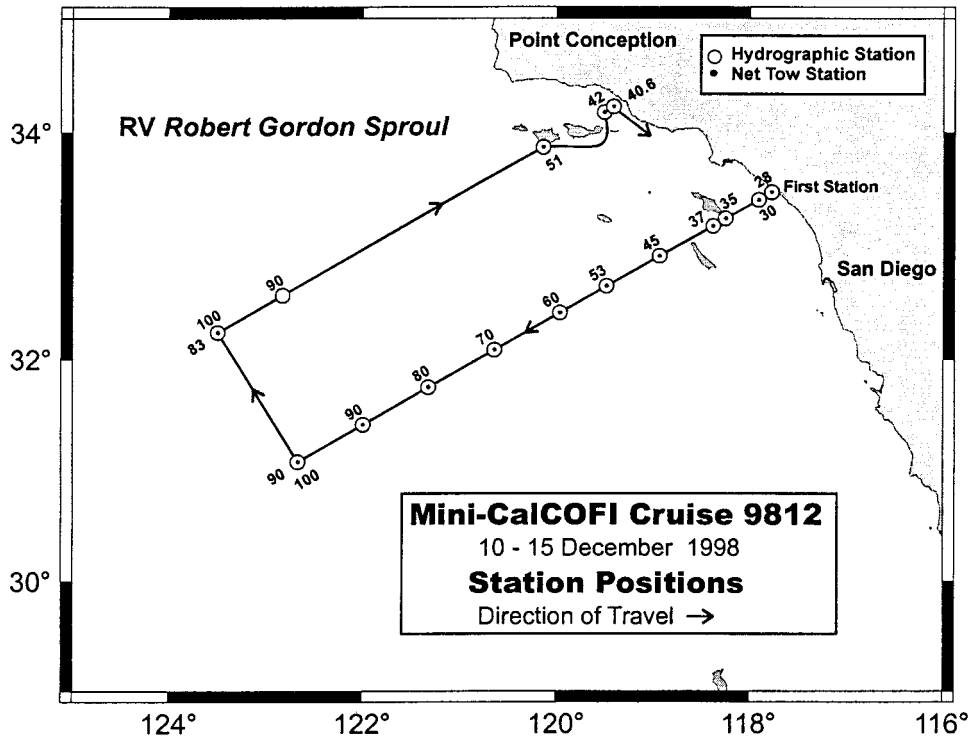
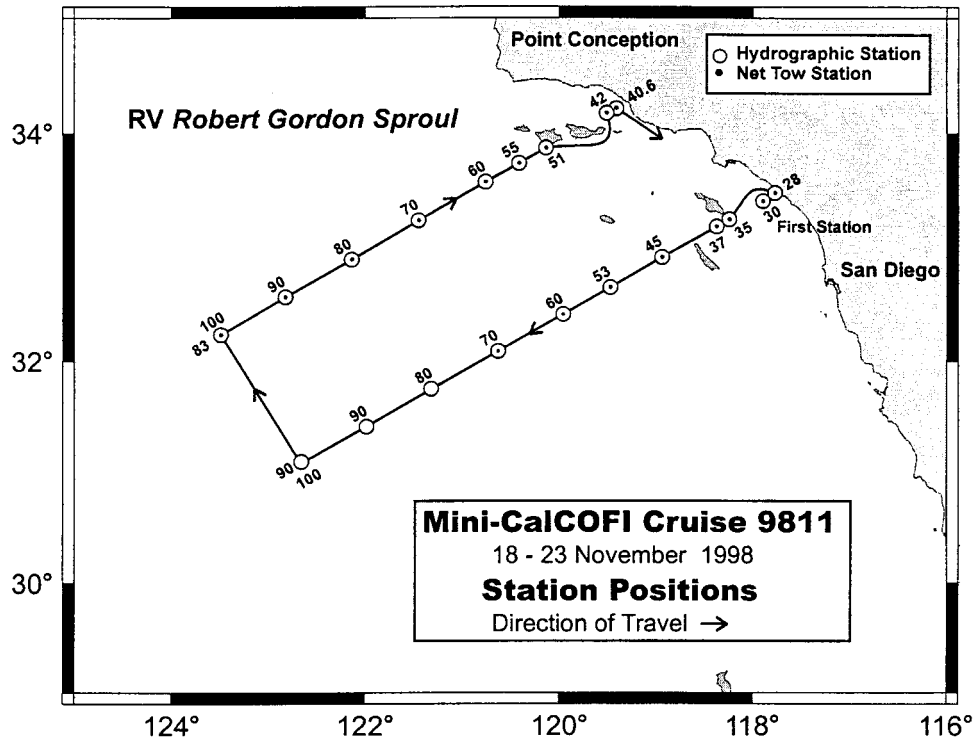

Figure 5. Stations and cruise tracks for Mini-CalCOFI Cruises 9811 (above) and 9812 (below). Symbols as in Figure 2. A Manta tow without an accompanying oblique tow was taken on Cruise 9811 at stations 90.0 60.0 and 90.0 70.0. A Bongo tow without an accompanying surface tow was taken on Cruise 9811 at station 83.3 40.6.

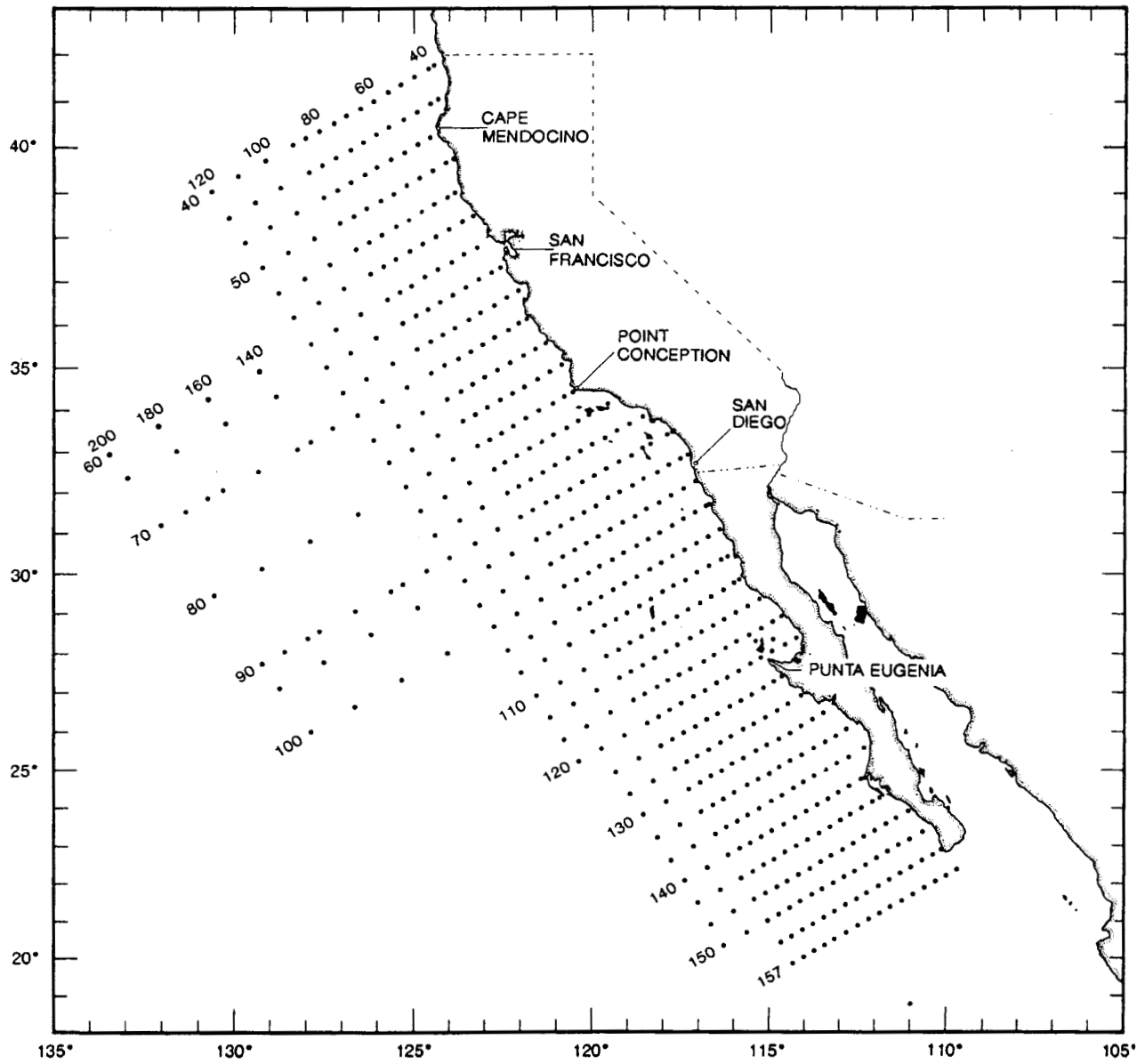

Figure 6. The basic CalCOFI station pattern occupied, in part, by cruises during 1951-1984.

TABLE 1. Station and plankton tow data for Manta net tows taken on the 1997 and 1998 Mini-CalCOFI survey cruises. Numbers of fish eggs and larvae are raw counts, unadjusted for volume (cubic meters) of water filtered.

CalCOFI Cruise 9712

Line	Station	Latitude (N)		Longitude (W)		Ship Code	Tow Date			Time (PST)	Volume		
		deg.	min.	deg.	min.		yr.	mo.	day		Water Strained	Total Larvae	Total Eggs
90.0	28.0	33	29.1	117	46.1	SP	97	12	13	2032	82	0	164
90.0	30.0	33	25.1	117	54.3	SP	97	12	13	1707	105	0	5
90.0	35.0	33	15.2	118	15.1	SP	97	12	14	0120	74	1	0
90.0	37.0	33	11.2	118	23.4	SP	97	12	14	0432	80	0	34
90.0	45.0	32	55.0	118	56.1	SP	97	12	14	1000	90	0	1
90.0	53.0	32	39.1	119	28.9	SP	97	12	14	1550	75	3	39
90.0	60.0	32	25.1	119	57.6	SP	97	12	14	2139	92	1	10
90.0	70.0	32	05.3	120	38.4	SP	97	12	15	0418	81	1	2
90.0	80.0	31	45.2	121	18.8	SP	97	12	15	1156	84	0	1

CalCOFI Cruise 9803

Line	Station	Latitude (N)		Longitude (W)		Ship Code	Tow Date			Time (PST)	Volume		
		deg.	min.	deg.	min.		yr.	mo.	day		Water Strained	Total Larvae	Total Eggs
83.3	40.6	34	13.4	119	24.9	SP	98	03	16	0246	82	6	750
83.3	42.0	34	10.7	119	30.5	SP	98	03	16	0015	104	5	1192
90.0	28.0	33	29.0	117	46.2	SP	98	03	11	1941	113	0	2710
90.0	35.0	33	15.0	118	15.0	SP	98	03	12	0120	100	0	873
90.0	37.0	33	11.1	118	23.2	SP	98	03	12	0447	108	39	440
90.0	45.0	32	55.2	118	56.1	SP	98	03	12	1017	101	3	2072
90.0	53.0	32	39.8	119	28.7	SP	98	03	12	1611	100	5	254
90.0	60.0	32	25.2	119	57.4	SP	98	03	12	2136	82	61	839
90.0	70.0	32	05.1	120	38.3	SP	98	03	13	0409	94	2	31
90.0	80.0	31	45.0	121	18.7	SP	98	03	13	1105	83	2	5
90.0	90.0	31	25.3	121	59.2	SP	98	03	13	1857	52	1	6

CalCOFI Cruise 9805

Line	Station	Latitude (N)		Longitude (W)		Ship Code	Tow Date			Time (PST)	Volume		
		deg.	min.	deg.	min.		yr.	mo.	day		Water Strained	Total Larvae	Total Eggs
83.3	40.6	34	13.5	119	24.8	SP	98	05	21	0858	103	55	181
83.3	42.0	34	10.6	119	30.5	SP	98	05	21	0648	95	2	4
83.3	51.0	33	52.6	120	08.0	SP	98	05	21	0006	85	7	3
90.0	28.0	33	29.1	117	46.1	SP	98	05	16	1904	90	29	3
90.0	30.0	33	25.1	117	54.3	SP	98	05	16	1624	87	0	0
90.0	35.0	33	15.1	118	15.0	SP	98	05	17	0004	73	5	3
90.0	37.0	33	11.1	118	23.2	SP	98	05	17	0407	86	266	0
90.0	45.0	32	55.1	118	55.9	SP	98	05	17	1011	96	2	0
90.0	80.0	31	45.0	121	18.8	SP	98	05	18	1315	65	2	82
90.0	90.0	31	25.0	121	59.2	SP	98	05	18	2015	62	3	26
90.0	100.0	31	05.1	122	39.6	SP	98	05	19	0344	79	4	207

CalCOFI Cruise 9806

Line	Station	Latitude (N)		Longitude (W)		Ship Code	Tow Date			Time (PST)	Volume		
		deg.	min.	deg.	min.		yr.	mo.	day		Water Strained	Total Larvae	Total Eggs
83.3	40.6	34	13.5	119	24.6	SP	98	06	22	0702	111	2	385

TABLE 1. (cont.)

CalCOFI Cruise 9806 (cont.)

Line	Station	Latitude (N)		Longitude (W)		Ship Code	Tow Date			Time (PST)	Volume		
		deg.	min.	deg.	min.		yr.	mo.	day		Water Strained	Total Larvae	Total Eggs
83.3	42.0	34	10.6	119	30.5	SP	98	06	22	0437	94	3	205
83.3	51.0	33	52.5	120	08.1	SP	98	06	21	2056	56	2	277
83.3	55.0	33	44.7	120	24.6	SP	98	06	21	1722	57	1	0
83.3	60.0	33	34.7	120	45.3	SP	98	06	21	1307	126	0	25
83.3	70.0	33	14.7	121	26.7	SP	98	06	21	0633	103	1	0
83.3	80.0	32	54.6	122	07.8	SP	98	06	21	0000	87	4	12
83.3	90.0	32	34.6	122	48.7	SP	98	06	20	1715	68	2	319
83.3	100.0	32	14.5	123	29.5	SP	98	06	20	1033	63	3	2186
90.0	28.0	33	29.0	117	46.2	SP	98	06	17	1856	80	10	747
90.0	30.0	33	25.1	117	54.2	SP	98	06	17	1611	98	0	1208
90.0	35.0	33	15.1	118	15.0	SP	98	06	17	2346	132	17	440
90.0	37.0	33	11.2	118	23.1	SP	98	06	18	0235	115	193	3
90.0	45.0	32	55.1	118	56.0	SP	98	06	18	0751	121	2	11
90.0	53.0	32	39.1	119	28.6	SP	98	06	18	1351	110	0	55
90.0	60.0	32	25.1	119	57.3	SP	98	06	18	1923	121	2	0
90.0	70.0	32	05.2	120	38.1	SP	98	06	19	0134	52	0	174
90.0	80.0	31	45.1	121	18.8	SP	98	06	19	0755	93	0	156
90.0	90.0	31	25.0	121	59.3	SP	98	06	19	1509	80	0	246
90.0	100.0	31	05.4	122	39.4	SP	98	06	19	2152	47	2	58

CalCOFI Cruise 9808

Line	Station	Latitude (N)		Longitude (W)		Ship Code	Tow Date			Time (PST)	Volume		
		deg.	min.	deg.	min.		yr.	mo.	day		Water Strained	Total Larvae	Total Eggs
83.3	40.6	34	13.3	119	24.8	SP	98	08	17	1208	85	3	1467
83.3	42.0	34	10.6	119	30.5	SP	98	08	17	1010	84	0	277
83.3	51.0	33	52.6	120	08.1	SP	98	08	17	0322	122	4	509
83.3	60.0	33	34.6	120	45.3	SP	98	08	16	1743	53	1	7
83.3	70.0	33	14.7	121	26.7	SP	98	08	16	1044	82	0	69
83.3	80.0	32	54.6	122	07.8	SP	98	08	16	0336	100	14	100
83.3	90.0	32	34.5	122	48.7	SP	98	08	15	2006	77	4	220
83.3	100.0	32	14.6	123	29.4	SP	98	08	15	1318	81	5	598
90.0	28.0	33	28.9	117	46.1	SP	98	08	12	1918	87	12	113
90.0	30.0	33	25.1	117	54.3	SP	98	08	12	1623	82	0	210
90.0	35.0	33	15.1	118	14.8	SP	98	08	13	0032	96	6	25
90.0	37.0	33	11.1	118	23.1	SP	98	08	13	0346	90	8	2
90.0	45.0	32	55.1	118	56.1	SP	98	08	13	0951	77	4	5
90.0	53.0	32	39.1	119	28.8	SP	98	08	13	1523	76	1	0
90.0	60.0	32	25.0	119	57.4	SP	98	08	13	2122	74	4	10
90.0	70.0	32	05.1	120	38.1	SP	98	08	14	0446	89	5	10
90.0	80.0	31	45.0	121	18.7	SP	98	08	14	1140	75	0	48
90.0	90.0	31	25.1	121	59.3	SP	98	08	14	1834	75	0	143
90.0	100.0	31	05.1	122	39.5	SP	98	08	15	0131	103	12	0

CalCOFI Cruise 9810

Line	Station	Latitude (N)		Longitude (W)		Ship Code	Tow Date			Time (PST)	Volume		
		deg.	min.	deg.	min.		yr.	mo.	day		Water Strained	Total Larvae	Total Eggs
83.3	40.6	34	13.4	119	24.9	SP	98	10	21	0909	92	1	0

TABLE 1. (cont.)

CalCOFI Cruise 9810 (cont.)

Line	Station	Latitude (N)		Longitude (W)		Ship Code	Tow Date			Time (PST)	Volume Water Strained	Total Larvae	Total Eggs
		deg.	min.	deg.	min.		yr.	mo.	day				
83.3	42.0	34	10.6	119	30.5	SP	98	10	21	0711	80	20	11
83.3	51.0	33	52.6	120	08.8	SP	98	10	21	0001	93	2	137
83.3	55.0	33	44.5	120	24.6	SP	98	10	20	2033	97	5	0
83.3	60.0	33	34.4	120	46.0	SP	98	10	20	1618	71	2	3
83.3	70.0	33	14.5	121	26.6	SP	98	10	20	0902	84	0	14
83.3	80.0	32	54.5	122	07.6	SP	98	10	20	0147	68	2	1
83.3	90.0	32	34.3	122	48.6	SP	98	10	19	1802	72	9	1
90.0	28.0	33	29.1	117	46.2	SP	98	10	16	1950	76	9	8
90.0	30.0	33	25.1	117	54.2	SP	98	10	16	1622	72	15	58
90.0	35.0	33	15.4	118	14.4	SP	98	10	17	0048	83	4	3
90.0	37.0	33	11.1	118	23.2	SP	98	10	17	0431	84	1	0
90.0	45.0	32	55.3	118	55.8	SP	98	10	17	1025	92	0	1
90.0	53.0	32	39.1	119	28.7	SP	98	10	17	1625	58	0	2
90.0	60.0	32	25.2	119	57.4	SP	98	10	17	2156	91	5	5
90.0	70.0	32	05.2	120	38.3	SP	98	10	18	0534	58	3	2
90.0	80.0	31	44.8	121	18.7	SP	98	10	18	1223	71	2	1
90.0	90.0	31	25.1	121	59.0	SP	98	10	18	1857	66	9	4

CalCOFI Cruise 9811

Line	Station	Latitude (N)		Longitude (W)		Ship Code	Tow Date			Time (PST)	Volume Water Strained	Total Larvae	Total Eggs
		deg.	min.	deg.	min.		yr.	mo.	day				
83.3	42.0	34	10.7	119	30.5	SP	98	11	23	1149	111	2	395
83.3	51.0	33	52.5	120	08.1	SP	98	11	23	0507	101	14	99
83.3	55.0	33	44.5	120	24.6	SP	98	11	23	0107	96	4	16
83.3	60.0	33	34.7	120	45.3	SP	98	11	22	2002	100	1	3
83.3	70.0	33	14.6	121	26.7	SP	98	11	22	1252	62	1	1
83.3	80.0	32	54.1	122	08.0	SP	98	11	22	0541	87	11	0
83.3	90.0	32	34.5	122	48.8	SP	98	11	21	2206	72	10	1
83.3	100.0	32	14.4	123	28.8	SP	98	11	21	1356	66	5	1
90.0	28.0	33	29.1	117	46.2	SP	98	11	18	2010	151	35	1567
90.0	30.0	33	24.8	117	53.6	SP	98	11	18	1723	99	16	198
90.0	35.0	33	15.1	118	14.7	SP	98	11	19	0140	106	1	23
90.0	37.0	33	11.3	118	22.5	SP	98	11	19	0435	90	6	0
90.0	45.0	32	55.1	118	56.1	SP	98	11	19	1033	114	2	0
90.0	53.0	32	39.1	119	28.1	SP	98	11	19	1645	80	1	0
90.0	60.0	32	24.9	119	57.3	SP	98	11	19	2204	91	9	1
90.0	70.0	32	05.3	120	37.5	SP	98	11	20	0507	84	0	1

CalCOFI Cruise 9812

Line	Station	Latitude (N)		Longitude (W)		Ship Code	Tow Date			Time (PST)	Volume Water Strained	Total Larvae	Total Eggs
		deg.	min.	deg.	min.		yr.	mo.	day				
83.3	40.6	34	13.8	119	24.6	SP	98	12	15	0552	102	3	65
83.3	42.0	34	10.7	119	30.4	SP	98	12	15	0357	78	10	27
83.3	51.0	33	52.6	120	08.0	SP	98	12	14	2043	52	5	62
83.3	100.0	32	14.6	123	29.4	SP	98	12	13	1339	115	3	3
90.0	28.0	33	29.1	117	46.1	SP	98	12	10	1720	90	237	1
90.0	30.0	33	25.0	117	54.3	SP	98	12	10	2038	165	24	40

TABLE 1. (cont.)

CalCOFI Cruise 9812 (cont.)

Line	Station	Latitude (N)		Longitude (W)		Ship Code	Tow Date			Time (PST)	Volume		
		deg.	min.	deg.	min.		yr.	mo.	day		Water Strained	Total Larvae	Total Eggs
90.0	35.0	33	15.1	118	15.0	SP	98	12	11	0105	135	5	1
90.0	37.0	33	11.1	118	22.9	SP	98	12	11	0410	94	2	0
90.0	45.0	32	55.1	118	55.9	SP	98	12	11	1008	145	0	2
90.0	53.0	32	39.1	119	28.9	SP	98	12	11	1610	101	3	1
90.0	60.0	32	25.1	119	57.5	SP	98	12	11	2138	92	2	1
90.0	70.0	32	05.1	120	38.2	SP	98	12	12	0440	95	11	1
90.0	80.0	31	45.1	121	18.8	SP	98	12	12	1138	96	7	3
90.0	90.0	31	25.0	121	59.3	SP	98	12	12	1849	105	11	0
90.0	100.0	31	05.1	122	39.7	SP	98	12	13	0201	105	7	1

TABLE 2. Pooled occurrences of fish larvae taken in Manta net tows on the 1997 and 1998 Mini-CalCOFI survey cruises.

Rank	Taxon	Occurrences
1	<i>Cololabis saira</i>	47
2	<i>Engraulis mordax</i>	29
3	<i>Hypsoblennius jenkinsi</i>	14
4	<i>Sardinops sagax</i>	11
5	<i>Scorpaenichthys marmoratus</i>	6
5	<i>Leuresthes tenuis</i>	6
7	<i>Sebastes</i> spp.	5
7	<i>Vinciguerrria lucetia</i>	5
7	<i>Chromis punctipinnis</i>	5
10	<i>Trachurus symmetricus</i>	4
10	<i>Hypsoblennius</i> spp.	4
10	<i>Sebastes diploproa</i>	4
13	<i>Hypsoblennius gentilis</i>	3
13	<i>Girella nigricans</i>	3
13	<i>Atherinopsis californiensis</i>	3
13	<i>Scomber japonicus</i>	3
13	<i>Ceratoscopelus townsendi</i>	3
13	<i>Sphyræna argentea</i>	3
19	<i>Fodiator acutus</i>	2
19	<i>Hypsoblennius gilberti</i>	2
19	<i>Cheilopogon</i> spp.	2
22	<i>Triphoturus mexicanus</i>	1
22	<i>Nannobrachium</i> spp.	1
22	<i>Lampadena urophaos</i>	1
22	<i>Diogenichthys atlanticus</i>	1
22	<i>Cyclothone signata</i>	1
22	<i>Lampanyctus steinbecki</i>	1
22	<i>Merluccius productus</i>	1
22	<i>Brosmophycis marginata</i>	1
22	<i>Cheilopogon heterurus</i>	1
22	<i>Macroramphosus gracilis</i>	1
22	<i>Pleuronichthys coenosus</i>	1
22	<i>Sebastes jordani</i>	1
22	<i>Paralabrax</i> spp.	1
22	<i>Genyonemus lineatus</i>	1
22	<i>Medialuna californiensis</i>	1
22	<i>Cheilopogon pinnatibarbatu</i>	1
	Total	180

TABLE 3. Pooled raw counts of fish larvae taken in Manta net tows on the 1997 and 1998 Mini-CalCOFI survey cruises.

Rank	Taxon	Count
1	<i>Engraulis mordax</i>	462
2	<i>Sardinops sagax</i>	357
3	<i>Hypsoblennius jenkinsi</i>	208
4	<i>Cololabis saira</i>	183
5	<i>Leuresthes tenuis</i>	26
6	<i>Chromis punctipinnis</i>	13
6	<i>Hypsoblennius</i> spp.	13
8	<i>Sebastes</i> spp.	12
9	<i>Atherinopsis californiensis</i>	11
10	<i>Trachurus symmetricus</i>	10
10	<i>Girella nigricans</i>	10
12	<i>Scorpaenichthys marmoratus</i>	8
12	<i>Hypsoblennius gilberti</i>	8
14	<i>Fodiator acutus</i>	5
14	<i>Vinciguerria lucetia</i>	5
14	<i>Sebastes diploproa</i>	5
17	<i>Sphyræna argentea</i>	3
17	<i>Ceratoscopelus townsendi</i>	3
17	<i>Scomber japonicus</i>	3
17	<i>Hypsoblennius gentilis</i>	3
17	<i>Macroramphosus gracilis</i>	3
22	<i>Cheilopogon heterurus</i>	2
22	<i>Cheilopogon</i> spp.	2
24	<i>Lampadena urophaos</i>	1
24	<i>Diogenichthys atlanticus</i>	1
24	<i>Genyonemus lineatus</i>	1
24	<i>Pleuronichthys coenosus</i>	1
24	<i>Nannobranchium</i> spp.	1
24	<i>Paralabrax</i> spp.	1
24	<i>Cheilopogon pinnatibarbus</i>	1
24	<i>Sebastes jordani</i>	1
24	<i>Lampanyctus steinbecki</i>	1
24	<i>Triphoturus mexicanus</i>	1
24	<i>Brosmophycis marginata</i>	1
24	<i>Cyclothone signata</i>	1
24	<i>Merluccius productus</i>	1
24	<i>Medialuna californiensis</i>	1
	Total	1369

TABLE 4. Numbers of fish larvae taken in Manta net tows on the 1997 and 1998 Mini-CalCOFI survey cruises, listed by taxon, station, and month. Numbers of larvae are expressed as larvae per 100 cubic meters of water filtered. Unoccupied stations are indicated by a dash.

Station	'97 Dec.	'98 Mar.	May	June	Aug.	Oct.	Nov.	Dec.
<i>Sardinops sagax</i>								
83.3 42.0	-	1.0	1.0	0.0	0.0	0.0	0.0	0.0
83.3 51.0	-	-	3.4	0.0	0.0	0.0	0.0	0.0
90.0 28.0	0.0	0.0	0.9	0.0	0.0	0.0	0.0	0.0
90.0 35.0	0.0	0.0	0.7	0.0	0.0	0.0	0.0	0.0
90.0 37.0	0.0	37.6	216.6	0.0	0.0	0.0	0.0	0.0
90.0 45.0	0.0	3.0	1.9	0.0	0.0	0.0	0.0	0.0
90.0 53.0	0.0	3.0	-	0.0	0.0	0.0	0.0	0.0
90.0 60.0	0.0	44.8	-	0.0	0.0	0.0	0.0	0.0
<i>Engraulis mordax</i>								
Station	'97 Dec.	'98 Mar.	May	June	Aug.	Oct.	Nov.	Dec.
83.3 40.6	-	0.0	55.4	0.0	2.5	0.0	-	0.0
83.3 42.0	-	0.0	0.0	0.0	0.0	15.9	0.0	7.8
83.3 51.0	-	-	0.9	0.6	2.4	1.9	9.1	2.6
83.3 55.0	-	-	-	0.0	-	3.9	0.0	-
83.3 60.0	-	-	-	0.0	0.0	0.0	1.0	-
90.0 28.0	0.0	0.0	0.0	0.8	0.0	5.3	46.7	209.3
90.0 30.0	0.0	-	0.0	0.0	0.0	10.1	11.8	38.0
90.0 35.0	0.0	0.0	0.7	7.9	0.0	0.0	0.0	0.0
90.0 37.0	0.0	4.3	6.0	4.6	0.0	0.0	0.9	0.0
90.0 45.0	0.0	0.0	0.0	1.2	0.0	0.0	0.0	0.0
90.0 60.0	0.0	0.0	-	0.0	0.0	2.7	1.8	0.9
<i>Cyclothone signata</i>								
Station	'97 Dec.	'98 Mar.	May	June	Aug.	Oct.	Nov.	Dec.
90.0 100.0	-	-	0.0	0.0	1.0	-	-	0.0
<i>Vinciguerria lucetia</i>								
Station	'97 Dec.	'98 Mar.	May	June	Aug.	Oct.	Nov.	Dec.
83.3 80.0	-	-	-	0.0	1.0	0.0	0.9	-
83.3 90.0	-	-	-	0.7	0.0	0.0	0.0	-
90.0 70.0	0.0	0.0	-	0.0	0.9	0.0	0.0	0.0

TABLE 4. (cont.)

Station 90.0 100.0						<i>Vinciguerria lucetia</i> (cont.)					
	'97 Dec.	'98 Mar.	May	June	Aug.		Oct.	Nov.	Dec.		
	-	-	0.0	0.0	1.0		-	-	0.0		
Station 83.3 80.0						<i>Ceratoscopelus townsendi</i>					
	'97 Dec.	'98 Mar.	May	June	Aug.		Oct.	Nov.	Dec.		
	-	-	-	0.9	0.0		0.0	0.0	-		
Station 83.3 90.0											
	-	-	-	0.0	0.0		0.7	0.0	-		
Station 90.0 100.0											
	-	-	0.0	0.0	0.0		-	-	1.1		
Station 90.0 60.0						<i>Lampadena urophaos</i>					
	'97 Dec.	'98 Mar.	May	June	Aug.		Oct.	Nov.	Dec.		
	0.9	0.0	-	0.0	0.0		0.0	0.0	0.0		
Station 90.0 90.0						<i>Lampanyctus steinbecki</i>					
	'97 Dec.	'98 Mar.	May	June	Aug.		Oct.	Nov.	Dec.		
	-	0.5	0.0	0.0	0.0		0.0	-	0.0		
Station 90.0 70.0						<i>Nannobrachium</i> spp.					
	'97 Dec.	'98 Mar.	May	June	Aug.		Oct.	Nov.	Dec.		
	0.0	0.0	-	0.0	0.0		0.0	0.0	1.0		
Station 90.0 70.0						<i>Triphoturus mexicanus</i>					
	'97 Dec.	'98 Mar.	May	June	Aug.		Oct.	Nov.	Dec.		
	0.0	0.0	-	0.0	0.0		0.6	0.0	0.0		
Station 90.0 53.0						<i>Diogenichthys atlanticus</i>					
	'97 Dec.	'98 Mar.	May	June	Aug.		Oct.	Nov.	Dec.		
	0.0	0.0	-	0.0	0.0		0.0	0.8	0.0		
Station 90.0 35.0						<i>Merluccius productus</i>					
	'97 Dec.	'98 Mar.	May	June	Aug.		Oct.	Nov.	Dec.		
	0.0	0.0	0.7	0.0	0.0		0.0	0.0	0.0		
Station 83.3 51.0						<i>Brosomphycis marginata</i>					
	'97 Dec.	'98 Mar.	May	June	Aug.		Oct.	Nov.	Dec.		
	-	-	0.0	0.0	0.0		0.0	1.0	0.0		
Station 83.3 40.6						<i>Atherinopsis californiensis</i>					
	'97 Dec.	'98 Mar.	May	June	Aug.		Oct.	Nov.	Dec.		
	-	4.9	0.0	0.0	0.0		0.0	-	0.0		
Station 83.3 42.0											
	-	4.2	0.0	0.0	0.0		0.0	1.1	0.0		

TABLE 4. (cont.)

		<i>Leuresthes tenuis</i>							
Station		'97 Dec.	'98 Mar.	May	June	Aug.	Oct.	Nov.	Dec.
83.3	40.6	-	0.0	1.0	2.2	0.0	0.0	-	0.0
83.3	42.0	-	0.0	1.0	0.0	0.0	0.0	0.0	0.0
83.3	55.0	-	-	-	0.6	-	0.0	0.0	-
90.0	28.0	0.0	0.0	17.1	0.0	0.0	0.0	0.0	0.0
90.0	35.0	0.0	0.0	1.5	0.0	0.0	0.0	0.0	0.0
		<i>Cololabis saira</i>							
Station		'97 Dec.	'98 Mar.	May	June	Aug.	Oct.	Nov.	Dec.
83.3	55.0	-	-	-	0.0	-	0.0	1.9	-
83.3	60.0	-	-	-	0.0	0.0	1.4	0.0	-
83.3	70.0	-	-	-	1.0	0.0	0.0	0.6	-
83.3	80.0	-	-	-	2.6	13.1	1.4	8.7	-
83.3	90.0	-	-	-	0.7	3.1	5.8	7.2	-
83.3	100.0	-	-	-	1.9	3.2	-	3.3	3.5
90.0	28.0	0.0	0.0	0.0	0.0	0.0	1.5	3.0	0.0
90.0	35.0	0.0	0.0	0.0	0.0	1.9	0.8	1.1	6.8
90.0	37.0	0.0	0.0	0.0	1.2	3.6	0.8	2.7	0.9
90.0	45.0	0.0	0.0	0.0	0.0	0.0	0.0	2.3	0.0
90.0	53.0	0.0	1.0	-	0.0	0.0	0.0	0.0	0.0
90.0	60.0	0.0	0.0	-	0.0	3.0	1.8	5.5	0.0
90.0	70.0	0.8	0.0	-	0.0	1.8	1.2	0.0	9.5
90.0	80.0	0.0	1.7	1.3	0.0	0.0	1.4	-	6.7
90.0	90.0	-	0.0	1.9	0.0	0.0	5.9	-	11.6
90.0	100.0	-	-	3.2	0.9	10.3	-	-	6.3
		<i>Cheilopogon</i> spp.							
Station		'97 Dec.	'98 Mar.	May	June	Aug.	Oct.	Nov.	Dec.
83.3	60.0	-	-	-	0.0	0.5	0.0	0.0	-
83.3	100.0	-	-	-	0.0	0.8	-	0.0	0.0
		<i>Cheilopogon heterurus</i>							
Station		'97 Dec.	'98 Mar.	May	June	Aug.	Oct.	Nov.	Dec.
90.0	35.0	0.0	0.0	0.0	0.0	1.9	0.0	0.0	0.0

TABLE 4. (cont.)

Station 90.0 35.0	<i>Cheilopogon pinnatibarbatus</i>		May	June	Aug.	Oct.	Nov.	Dec.
	'98 Mar.	'97 Dec.	0.0	0.0	0.0	0.8	0.0	0.0
Station 90.0 37.0 90.0 45.0	<i>Fodiator acutus</i>		May	June	Aug.	Oct.	Nov.	Dec.
	'98 Mar.	'97 Dec.	0.0	0.0	0.9	0.0	0.0	0.0
			0.0	0.0	3.1	0.0	0.0	0.0
Station 90.0 53.0	<i>Macroramphosus gracilis</i>		May	June	Aug.	Oct.	Nov.	Dec.
	'98 Mar.	'97 Dec.	-	0.0	0.0	0.0	0.0	3.0
Station 83.3 40.6 83.3 42.0 90.0 28.0 90.0 37.0 90.0 53.0	<i>Sebastes spp.</i>		May	June	Aug.	Oct.	Nov.	Dec.
	'98 Mar.	'97 Dec.	0.0	0.0	0.0	0.0	-	1.0
			0.0	0.0	0.0	0.0	1.1	0.0
			0.0	0.0	0.0	0.0	0.0	0.9
			5.2	0.0	0.0	0.0	0.0	0.0
			-	0.0	0.0	0.0	0.0	0.0
Station 83.3 40.6 83.3 51.0 90.0 35.0	<i>Sebastes diploproa</i>		May	June	Aug.	Oct.	Nov.	Dec.
	'98 Mar.	'97 Dec.	0.0	0.0	0.0	0.9	-	0.0
			0.9	0.0	0.0	0.0	2.0	0.0
			0.0	0.0	0.0	0.0	0.0	0.0
Station 83.3 51.0	<i>Sebastes jordani</i>		May	June	Aug.	Oct.	Nov.	Dec.
	'98 Mar.	'97 Dec.	0.9	0.0	0.0	0.0	0.0	0.0
Station 83.3 40.6 83.3 51.0 83.3 55.0 90.0 28.0 90.0 30.0 90.0 60.0	<i>Scorpaenichthys marmoratus</i>		May	June	Aug.	Oct.	Nov.	Dec.
	'98 Mar.	'97 Dec.	0.0	0.0	0.0	0.0	-	1.0
			-	0.0	0.0	0.0	2.0	0.0
			-	0.0	-	0.0	1.9	-
			0.0	0.0	0.0	0.0	0.0	0.9
			0.0	0.0	0.0	0.0	0.0	1.7
			-	0.0	0.0	0.0	0.9	0.0

TABLE 4. (cont.)

Station 90.0 28.0	'97 Dec. 0.0	'98 Mar. 0.0	May 0.0	June 0.0	Aug. 0.9	Oct. 0.0	Nov. 0.0	Dec. 0.0
<i>Paralabrax spp.</i>								
Station 90.0 53.0	'97 Dec. 0.0	'98 Mar. 1.0	May -	June 0.0	Aug. 0.0	Oct. 0.0	Nov. 0.0	Dec. 0.0
90.0 60.0	0.0	4.1	-	2.4	0.0	0.0	0.0	0.0
90.0 70.0	0.0	1.9	-	0.0	0.0	0.0	0.0	0.0
<i>Trachurus symmetricus</i>								
Station 90.0 28.0	'97 Dec. 0.0	'98 Mar. 0.0	May 0.0	June 0.0	Aug. 0.0	Oct. 0.0	Nov. 1.5	Dec. 0.0
<i>Genyonemus lineatus</i>								
Station 90.0 28.0	'97 Dec. 0.0	'98 Mar. 0.0	May 0.0	June 6.4	Aug. 0.0	Oct. 0.0	Nov. 0.0	Dec. 0.0
90.0 35.0	0.0	0.0	0.0	1.3	0.0	0.0	0.0	0.0
90.0 37.0	0.0	0.0	0.0	1.2	0.0	0.0	0.0	0.0
<i>Girella nigricans</i>								
Station 90.0 53.0	'97 Dec. 0.0	'98 Mar. 0.0	May -	June 0.0	Aug. 0.8	Oct. 0.0	Nov. 0.0	Dec. 0.0
<i>Medialuna californiensis</i>								
Station 90.0 28.0	'97 Dec. 0.0	'98 Mar. 0.0	May 0.9	June 0.0	Aug. 7.8	Oct. 0.0	Nov. 0.0	Dec. 0.0
90.0 35.0	0.0	0.0	0.0	0.0	1.0	0.8	0.0	0.0
90.0 60.0	0.0	0.0	-	0.0	0.0	0.0	0.0	0.9
<i>Chromis punctipinnis</i>								
Station 83.3 51.0	'97 Dec. -	'98 Mar. -	May 0.0	June 0.6	Aug. 0.0	Oct. 0.0	Nov. 0.0	Dec. 0.0
90.0 28.0	0.0	0.0	7.2	0.0	1.7	0.0	0.0	0.0
90.0 30.0	0.0	-	0.0	0.0	0.0	0.0	2.0	0.0
<i>Hypsoblennius spp.</i>								
Station 90.0 30.0	'97 Dec. 0.0	'98 Mar. -	May 0.0	June 0.0	Aug. 0.0	Oct. 0.0	Nov. 1.0	Dec. 0.0
90.0 45.0	0.0	0.0	0.0	1.2	0.0	0.7	0.0	0.0
<i>Hypsoblennius gentilis</i>								

TABLE 4. (cont.)

		<i>Hypsoblennius gilberti</i>				<i>Hypsoblennius jenkinsi</i>				<i>Sphyraena argentea</i>				<i>Scomber japonicus</i>				<i>Pleuronichthys coenosus</i>							
Station		'97 Dec.	'98 Mar.	May	June	Aug.	Oct.	Nov.	Dec.	'97 Dec.	'98 Mar.	May	June	Aug.	Oct.	Nov.	Dec.	'97 Dec.	'98 Mar.	May	June	Aug.	Oct.	Nov.	Dec.
83.3	55.0	-	-	-	0.0	-	1.0	0.0	-	-	0.0	0.0	0.0	0.0	0.0	0.0	0.0	-	-	-	0.0	-	1.0	0.0	1.0
90.0	37.0	0.0	0.0	0.0	8.1	0.0	0.0	0.0	0.0	0.0	0.0	0.0	0.0	0.0	0.0	0.0	0.0	0.0	0.0	0.0	0.0	0.0	0.0	0.0	0.0
83.3	40.6	-	0.0	0.0	0.0	0.0	0.0	0.0	0.0	0.0	0.0	0.0	0.0	0.0	0.0	0.0	0.0	0.0	0.0	0.0	0.0	0.0	0.0	0.0	0.0
83.3	42.0	-	0.0	0.0	2.8	0.0	0.0	0.0	0.0	0.0	0.0	0.0	0.0	0.0	0.0	0.0	0.0	0.0	0.0	0.0	0.0	0.0	0.0	0.0	0.0
83.3	51.0	-	-	0.0	0.0	1.2	0.0	0.0	0.0	0.0	0.0	0.0	0.0	0.0	0.0	0.0	0.0	0.0	0.0	0.0	0.0	0.0	0.0	0.0	0.0
90.0	28.0	0.0	0.0	0.0	0.0	0.0	0.0	0.0	0.0	0.0	0.0	0.0	0.0	0.0	0.0	0.0	0.0	0.0	0.0	0.0	0.0	0.0	0.0	0.0	2.7
90.0	30.0	0.0	-	0.0	0.0	0.0	0.0	0.0	0.0	0.0	0.0	0.0	0.0	0.0	0.0	0.0	0.0	0.0	0.0	0.0	0.0	0.0	0.0	0.0	0.0
90.0	35.0	0.0	0.0	0.0	13.2	1.0	0.8	0.0	0.0	0.0	0.0	0.0	0.0	0.0	0.8	0.0	0.0	0.0	0.0	0.0	0.0	0.0	0.0	0.0	0.0
90.0	37.0	0.0	0.0	0.9	206.0	2.7	0.0	0.9	0.9	0.0	0.0	0.0	0.0	2.7	0.0	0.9	0.9	0.0	0.0	0.0	0.0	0.0	0.0	0.9	0.9
90.0	70.0	0.0	0.0	-	0.0	1.8	0.0	0.0	0.0	0.0	0.0	0.0	0.0	1.8	0.0	0.0	0.0	0.0	0.0	0.0	0.0	0.0	0.0	0.0	0.0
83.3	51.0	-	-	0.0	0.0	1.2	0.0	0.0	0.0	0.0	0.0	0.0	0.0	1.2	0.0	0.0	0.0	0.0	0.0	0.0	0.0	0.0	0.0	0.0	0.0
90.0	28.0	0.0	0.0	0.0	0.8	0.0	0.0	0.0	0.0	0.0	0.0	0.0	0.0	0.0	0.0	1.5	0.0	0.0	0.0	0.0	0.0	0.0	0.0	0.0	0.0
90.0	37.0	0.0	0.0	0.9	1.2	0.0	0.0	0.0	0.0	0.0	0.0	0.0	0.0	0.0	0.0	0.0	0.0	0.0	0.0	0.0	0.0	0.0	0.0	0.0	0.0
90.0	60.0	0.0	0.8	-	0.0	0.0	0.0	0.0	0.0	0.0	0.0	0.0	0.0	0.0	0.0	0.0	0.0	0.0	0.0	0.0	0.0	0.0	0.0	0.0	0.0
90.0	37.0	0.0	0.0	0.0	0.0	0.0	0.0	0.0	0.0	0.0	0.0	0.0	0.0	0.0	0.0	0.9	0.0	0.0	0.0	0.0	0.0	0.0	0.0	0.9	0.0

TABLE 5. Station and Bongo net tows data for 1997 and 1998 Mini-CalCOFI survey cruises. Counts for fish eggs and larvae are not adjusted for standard haul factor or percent of sample sorted. Plankton volume given as milliliters per 1000 cubic meters of water strained.

CalCOFI Cruise 9712													
Line	Station	Latitude (N) deg. min.	Longitude (W) deg. min.	Ship Code	Tow Date yr. mo. day	Time (PST)	Tow Depth (m)	Volume Water Strained	Standard Haul Factor	Plankton Volume	Percent Sorted	Total Larvae	Total Eggs
90.0	28.0	33 29.1	117 46.1	SP	97 12 13	2105	47	126	3.72	32	100.0	10	27
90.0	30.0	33 25.1	117 54.3	SP	97 12 13	1748	215	413	5.21	34	100.0	7	3
90.0	35.0	33 15.2	118 15.1	SP	97 12 14	0149	190	372	5.12	35	100.0	8	300
90.0	37.0	33 11.2	118 23.4	SP	97 12 14	0501	206	424	4.86	28	100.0	9	93
90.0	45.0	32 55.0	118 56.1	SP	97 12 14	1023	206	407	5.07	34	100.0	2	1
90.0	53.0	32 39.1	119 28.9	SP	97 12 14	1616	219	424	5.17	28	100.0	13	20
90.0	60.0	32 25.1	119 57.6	SP	97 12 14	2205	202	521	3.87	36	100.0	42	96
90.0	70.0	32 05.3	120 38.4	SP	97 12 15	0445	195	473	4.12	44	100.0	17	12

CalCOFI Cruise 9803

CalCOFI Cruise 9803													
Line	Station	Latitude (N) deg. min.	Longitude (W) deg. min.	Ship Code	Tow Date yr. mo. day	Time (PST)	Tow Depth (m)	Volume Water Strained	Standard Haul Factor	Plankton Volume	Percent Sorted	Total Larvae	Total Eggs
83.3	42.0	34 10.7	119 30.5	SP	98 03 16	0041	67	226	2.95	89	100.0	75	349
90.0	28.0	33 29.0	117 46.2	SP	98 03 11	2020	47	130	3.59	46	100.0	103	307
90.0	30.0	33 25.1	117 54.2	SP	98 03 11	1659	211	441	4.80	18	100.0	55	25
90.0	35.0	33 15.0	118 15.0	SP	98 03 12	0147	205	460	4.46	30	100.0	103	114
90.0	37.0	33 11.1	118 23.2	SP	98 03 12	0511	200	423	4.72	31	100.0	26	85
90.0	45.0	32 55.2	118 56.1	SP	98 03 12	1036	198	421	4.72	45	52.6	149	408
90.0	53.0	32 39.8	119 28.7	SP	98 03 12	1631	216	430	5.01	21	100.0	89	133
90.0	60.0	32 25.2	119 57.4	SP	98 03 12	2157	208	433	4.79	30	100.0	175	67
90.0	70.0	32 05.1	120 38.3	SP	98 03 13	0430	203	455	4.47	20	100.0	91	34
90.0	80.0	31 45.0	121 18.7	SP	98 03 13	1126	203	508	3.99	12	100.0	24	36
90.0	90.0	31 25.3	121 59.2	SP	98 03 13	1929	208	575	3.61	7	100.0	37	75

CalCOFI Cruise 9805

CalCOFI Cruise 9805													
Line	Station	Latitude (N) deg. min.	Longitude (W) deg. min.	Ship Code	Tow Date yr. mo. day	Time (PST)	Tow Depth (m)	Volume Water Strained	Standard Haul Factor	Plankton Volume	Percent Sorted	Total Larvae	Total Eggs
83.3	40.6	34 13.5	119 24.8	SP	98 05 21	0919	21	49	4.33	41	100.0	2	10

TABLE 5. (cont.)

CalCOFI Cruise 9805 (cont.)													
Line	Station	Latitude (N) deg. min.	Longitude (W) deg. min.	Ship Code	Tow Date yr. mo. day	Time (PST)	Tow Depth (m)	Volume Water Strained	Standard Haul Factor	Plankton Volume	Percent Sorted	Total Larvae	Total Eggs
83.3	42.0	34 10.6	119 30.5	SP	98 05 21	0710	152	312	4.87	173	48.1	24	2
83.3	51.0	33 52.6	120 08.0	SP	98 05 21	0029	110	265	4.14	113	46.7	16	0
90.0	28.0	33 29.1	117 46.1	SP	98 05 16	1927	86	179	4.78	117	100.0	7	55
90.0	30.0	33 25.1	117 54.3	SP	98 05 16	1647	227	440	5.15	52	100.0	5	3
90.0	35.0	33 15.1	118 15.0	SP	98 05 17	0030	207	465	4.46	47	100.0	38	1
90.0	37.0	33 11.1	118 23.2	SP	98 05 17	0429	208	437	4.75	46	100.0	11	0
90.0	45.0	32 55.1	118 55.9	SP	98 05 17	1043	211	453	4.65	26	100.0	20	0
90.0	80.0	31 45.0	121 18.8	SP	98 05 18	1335	214	468	4.57	9	100.0	77	136
90.0	100.0	31 05.1	122 39.6	SP	98 05 19	0406	207	476	4.35	11	100.0	125	422

CalCOFI Cruise 9806

CalCOFI Cruise 9806													
Line	Station	Latitude (N) deg. min.	Longitude (W) deg. min.	Ship Code	Tow Date yr. mo. day	Time (PST)	Tow Depth (m)	Volume Water Strained	Standard Haul Factor	Plankton Volume	Percent Sorted	Total Larvae	Total Eggs
83.3	40.6	34 13.5	119 24.6	SP	98 06 22	0725	20	82	2.49	36	100.0	4	52
83.3	42.0	34 10.6	119 30.5	SP	98 06 22	0458	175	387	4.51	338	51.1	2	6
83.3	51.0	33 52.5	120 08.1	SP	98 06 21	2116	191	421	4.54	501	48.8	8	11
83.3	55.0	33 44.7	120 24.6	SP	98 06 21	1742	215	401	5.35	90	47.2	5	0
83.3	60.0	33 34.7	120 45.3	SP	98 06 21	1327	206	384	5.36	117	51.1	12	7
83.3	70.0	33 14.7	121 26.7	SP	98 06 21	0653	211	463	4.57	30	100.0	11	5
83.3	80.0	32 54.6	122 07.8	SP	98 06 21	0019	206	498	4.13	32	100.0	564	63
83.3	90.0	32 34.6	122 48.7	SP	98 06 20	1735	213	452	4.71	11	100.0	178	582
83.3	100.0	32 14.5	123 29.5	SP	98 06 20	1053	208	483	4.31	12	100.0	34	1311
90.0	28.0	33 29.0	117 46.2	SP	98 06 17	1919	70	148	4.71	108	100.0	11	235
90.0	30.0	33 25.1	117 54.2	SP	98 06 17	1635	213	423	5.03	21	100.0	18	282
90.0	35.0	33 15.1	118 15.0	SP	98 06 18	0009	205	415	4.93	63	100.0	11	24
90.0	37.0	33 11.2	118 23.1	SP	98 06 18	0255	212	426	4.99	113	52.1	7	0
90.0	45.0	32 55.1	118 56.0	SP	98 06 18	0812	209	450	4.63	64	48.3	2	0
90.0	53.0	32 39.1	119 28.6	SP	98 06 18	1412	213	398	5.35	60	54.2	4	4
90.0	60.0	32 25.1	119 57.3	SP	98 06 18	1945	212	421	5.02	43	100.0	82	7
90.0	70.0	32 05.2	120 38.1	SP	98 06 19	0153	215	455	4.72	26	100.0	115	198
90.0	80.0	31 45.1	121 18.8	SP	98 06 19	0815	214	460	4.64	13	100.0	278	410
90.0	90.0	31 25.0	121 59.3	SP	98 06 19	1531	215	437	4.90	11	100.0	242	250
90.0	100.0	31 05.4	122 39.4	SP	98 06 19	2214	215	464	4.63	26	100.0	19	123

TABLE 5. (cont.)

CalCOFI Cruise 9808													
Line	Station	Latitude (N) deg. min.	Longitude (W) deg. min.	Ship Code	Tow Date yr. mo. day	Time (PST)	Tow Depth (m)	Volume Water Strained	Standard Haul Factor	Plankton Volume	Percent Sorted	Total Larvae	Total Eggs
83.3	40.6	34 13.3	119 24.8	SP	98 08 17	1228	20	75	2.66	67	100.0	102	928
83.3	42.0	34 10.6	119 30.5	SP	98 08 17	1031	97	206	4.71	44	100.0	178	354
83.3	51.0	33 52.6	120 08.1	SP	98 08 17	0330	214	445	4.81	22	100.0	13	94
83.3	55.0	33 44.6	120 24.7	SP	98 08 16	2250	193	579	3.33	116	52.2	3	0
83.3	60.0	33 34.6	120 45.3	SP	98 08 16	1806	204	534	3.82	51	51.9	10	2
83.3	80.0	32 54.6	122 07.8	SP	98 08 16	0400	211	469	4.50	30	100.0	152	333
83.3	90.0	32 34.5	122 48.7	SP	98 08 15	2026	210	448	4.68	25	100.0	203	340
83.3	100.0	32 14.6	123 29.4	SP	98 08 15	1337	214	446	4.79	13	100.0	178	1427
90.0	28.0	33 28.9	117 46.1	SP	98 08 12	1939	214	416	5.15	46	100.0	5	14
90.0	30.0	33 25.1	117 54.3	SP	98 08 12	1644	218	420	5.19	5	100.0	1	24
90.0	35.0	33 15.1	118 14.8	SP	98 08 13	0055	186	461	4.04	93	53.5	6	0
90.0	37.0	33 11.1	118 23.1	SP	98 08 13	0409	195	490	3.97	171	53.6	6	2
90.0	53.0	32 39.1	119 28.8	SP	98 08 13	1545	214	429	4.99	28	100.0	74	9
90.0	60.0	32 25.0	119 57.4	SP	98 08 13	2143	209	443	4.71	45	100.0	161	18
90.0	70.0	32 05.1	120 38.1	SP	98 08 14	0508	211	436	4.85	62	100.0	131	65
90.0	80.0	31 45.0	121 18.7	SP	98 08 14	1200	203	456	4.45	22	100.0	141	371
90.0	90.0	31 25.1	121 59.3	SP	98 08 14	1854	209	438	4.76	30	100.0	179	185
90.0	100.0	31 05.1	122 39.5	SP	98 08 15	0155	200	465	4.31	22	100.0	375	76

CalCOFI Cruise 9810													
Line	Station	Latitude (N) deg. min.	Longitude (W) deg. min.	Ship Code	Tow Date yr. mo. day	Time (PST)	Tow Depth (m)	Volume Water Strained	Standard Haul Factor	Plankton Volume	Percent Sorted	Total Larvae	Total Eggs
83.3	40.6	34 13.4	119 24.9	SP	98 10 21	0929	28	92	2.99	54	100.0	5	37
83.3	42.0	34 10.6	119 30.5	SP	98 10 21	0739	135	220	6.14	27	100.0	7	6
83.3	51.0	33 52.6	120 08.8	SP	98 10 21	0022	110	281	3.91	50	100.0	3	75
83.3	55.0	33 44.5	120 24.6	SP	98 10 20	2052	210	450	4.67	102	52.2	4	1
83.3	60.0	33 34.4	120 46.0	SP	98 10 20	1640	200	467	4.30	32	100.0	3	1
83.3	70.0	33 14.5	121 26.6	SP	98 10 20	0923	204	450	4.52	47	100.0	2	9
83.3	80.0	32 54.5	122 07.6	SP	98 10 20	0212	208	447	4.66	27	100.0	14	4
83.3	90.0	32 34.3	122 48.6	SP	98 10 19	1822	213	457	4.66	20	100.0	13	4
90.0	28.0	33 29.1	117 46.2	SP	98 10 16	2016	67	200	3.33	45	100.0	31	11
90.0	30.0	33 25.1	117 54.2	SP	98 10 16	1642	210	447	4.71	22	100.0	13	62
90.0	35.0	33 15.4	118 14.4	SP	98 10 17	0111	202	429	4.71	56	100.0	3	0

TABLE 5. (cont.)

CalCOFI Cruise 9810 (cont.)													
Line	Station	Latitude (N) deg. min.	Longitude (W) deg. min.	Ship Code	Tow Date yr. mo. day	Time (PST)	Tow Depth (m)	Volume Water Strained	Standard Haul Factor	Plankton Volume	Percent Sorted	Total Larvae	Total Eggs
90.0	37.0	33 11.1	118 23.2	SP	98 10 17	0450	208	443	4.69	36	100.0	6	0
90.0	45.0	32 55.3	118 55.8	SP	98 10 17	1046	213	422	5.04	59	100.0	0	1
90.0	53.0	32 39.1	119 28.7	SP	98 10 17	1646	219	452	4.85	35	100.0	6	3
90.0	60.0	32 25.2	119 57.4	SP	98 10 17	2218	213	457	4.66	52	100.0	17	1
90.0	80.0	31 44.8	121 18.7	SP	98 10 18	1244	213	445	4.79	61	100.0	1	3
CalCOFI Cruise 9811													
Line	Station	Latitude (N) deg. min.	Longitude (W) deg. min.	Ship Code	Tow Date yr. mo. day	Time (PST)	Tow Depth (m)	Volume Water Strained	Standard Haul Factor	Plankton Volume	Percent Sorted	Total Larvae	Total Eggs
83.3	40.6	34 13.4	119 24.7	SP	98 11 23	1346	27	75	3.67	13	100.0	1	8
83.3	42.0	34 10.7	119 30.5	SP	98 11 23	1130	115	273	4.21	33	100.0	7	126
83.3	51.0	33 52.5	120 08.1	SP	98 11 23	0437	192	504	3.81	18	100.0	8	93
83.3	55.0	33 44.5	120 24.6	SP	98 11 23	0038	203	488	4.17	53	53.8	7	39
83.3	60.0	33 34.7	120 45.3	SP	98 11 22	1933	204	497	4.11	157	52.6	3	2
83.3	70.0	33 14.6	121 26.7	SP	98 11 22	1223	206	521	3.95	59	48.4	3	182
83.3	80.0	32 54.1	122 08.0	SP	98 11 22	0510	214	474	4.51	38	100.0	6	14
83.3	90.0	32 34.5	122 48.8	SP	98 11 21	2136	206	414	4.99	53	100.0	15	7
83.3	100.0	32 14.4	123 28.8	SP	98 11 21	1423	211	462	4.57	24	100.0	9	8
90.0	28.0	33 29.1	117 46.2	SP	98 11 18	2030	206	444	4.64	34	100.0	102	1916
90.0	30.0	33 24.8	117 53.6	SP	98 11 18	1756	212	411	5.15	32	100.0	31	40
90.0	35.0	33 15.1	118 14.7	SP	98 11 19	0110	204	452	4.51	75	50.0	3	4
90.0	37.0	33 11.3	118 22.5	SP	98 11 19	0406	207	463	4.47	61	100.0	1	0
90.0	45.0	32 55.1	118 56.1	SP	98 11 19	1005	210	478	4.40	59	50.0	2	23
90.0	53.0	32 39.1	119 28.1	SP	98 11 19	1616	215	458	4.69	55	48.0	5	21
CalCOFI Cruise 9812													
Line	Station	Latitude (N) deg. min.	Longitude (W) deg. min.	Ship Code	Tow Date yr. mo. day	Time (PST)	Tow Depth (m)	Volume Water Strained	Standard Haul Factor	Plankton Volume	Percent Sorted	Total Larvae	Total Eggs
83.3	40.6	34 13.8	119 24.6	SP	98 12 15	0543	23	73	3.16	41	100.0	0	15
83.3	42.0	34 10.7	119 30.4	SP	98 12 15	0334	130	293	4.45	103	53.3	6	75
83.3	51.0	33 52.6	120 08.0	SP	98 12 14	2025	78	199	3.91	30	100.0	1	62

TABLE 5. (cont.)

CalCOFI Cruise 9812 (cont.)													
Line	Station	Latitude (N) deg. min.	Longitude (W) deg. min.	Ship Code	Tow Date yr. mo. day	Time (PST)	Tow Depth (m)	Volume Water Strained	Standard Haul Factor	Plankton Volume	Percent Sorted	Total Larvae	Total Eggs
83.3	100.0	32 14.6	123 29.4	SP	98 12 13	1311	207	434	4.77	12	100.0	16	9
90.0	28.0	33 29.1	117 46.1	SP	98 12 10	1707	56	131	4.30	53	100.0	12	3
90.0	30.0	33 25.0	117 54.3	SP	98 12 10	2010	205	404	5.08	40	100.0	34	8
90.0	35.0	33 15.1	118 15.0	SP	98 12 11	0037	204	437	4.67	78	52.9	3	51
90.0	37.0	33 11.1	118 22.9	SP	98 12 11	0342	191	463	4.12	69	46.9	5	1
90.0	45.0	32 55.1	118 55.9	SP	98 12 11	0939	200	450	4.44	56	52.0	4	18
90.0	53.0	32 39.1	119 28.9	SP	98 12 11	1539	210	409	5.14	47	100.0	9	164
90.0	60.0	32 25.1	119 57.5	SP	98 12 11	2109	210	405	5.19	101	51.2	7	62
90.0	70.0	32 05.1	120 38.2	SP	98 12 12	0410	217	454	4.79	35	100.0	6	3
90.0	80.0	31 45.1	121 18.8	SP	98 12 12	1107	213	473	4.51	15	100.0	5	1
90.0	90.0	31 25.0	121 59.3	SP	98 12 12	1819	206	442	4.66	29	100.0	19	6
90.0	100.0	31 05.1	122 39.7	SP	98 12 13	0128	200	516	3.87	83	100.0	6	4

TABLE 6. Pooled occurrences of fish larvae taken in Bongo net tows on the 1997 and 1998 Mini-CalCOFI survey cruises.

Rank	Taxon	Occurrences
1	<i>Engraulis mordax</i>	40
2	<i>Vinciguerria lucetia</i>	39
2	<i>Triphoturus mexicanus</i>	39
4	<i>Protomyctophum crockeri</i>	38
5	<i>Cyclothone signata</i>	36
5	<i>Diogenichthys atlanticus</i>	36
7	<i>Sebastes</i> spp.	29
8	<i>Ceratoscopelus townsendi</i>	27
9	<i>Bathylagus wesethi</i>	22
9	<i>Stenobranchius leucopsarus</i>	22
11	<i>Symbolophorus californiensis</i>	20
12	<i>Leuroglossus stilbius</i>	18
13	<i>Bathylagus ochotensis</i>	16
13	<i>Nannobranchium ritteri</i>	16
15	<i>Lestidiops ringens</i>	14
16	<i>Nannobranchium</i> spp.	13
16	<i>Merluccius productus</i>	13
18	<i>Stomias atriventer</i>	11
18	<i>Sardinops sagax</i>	11
18	<i>Idiacanthus antrostomus</i>	11
21	<i>Argyropelecus sladeni</i>	9
21	<i>Hygophum reinhardtii</i>	9
21	<i>Citharichthys stigmaeus</i>	9
24	<i>Melamphaes lugubris</i>	8
24	<i>Citharichthys sordidus</i>	8
24	<i>Trachurus symmetricus</i>	8
27	<i>Sternoptyx</i> spp.	7
28	<i>Myctophum nitidulum</i>	6
28	<i>Scopelogadus bispinosus</i>	6
28	<i>Chiasmodon niger</i>	6
31	<i>Paralichthys californicus</i>	5
31	<i>Notoscopelus resplendens</i>	5
31	<i>Scomber japonicus</i>	5
31	<i>Argentina sialis</i>	5
31	<i>Diogenichthys laternatus</i>	5
36	<i>Tarletonbeania crenularis</i>	4
36	<i>Chromis punctipinnis</i>	4
36	<i>Rosenblattichthys volucris</i>	4
36	<i>Lampadena urophaos</i>	4
36	<i>Danaphos oculatus</i>	4
36	<i>Chauliodus macouni</i>	4
36	<i>Sebastes diploproa</i>	4
36	<i>Microstoma</i> spp.	4
36	<i>Poromitra crassiceps</i>	4
45	<i>Hypsoblennius jenkinsi</i>	3
45	<i>Bathylagus pacificus</i>	3
45	<i>Nannobranchium regale</i>	3
45	<i>Argyropelecus affinis</i>	3
45	<i>Argyropelecus lychnus</i>	3
45	<i>Lampanyctus steinbecki</i>	3

TABLE 6. (cont.)

Rank	Taxon	Occurrences
45	<i>Coryphopterus nicholsii</i>	3
45	<i>Diaphus</i> spp.	3
45	<i>Ichthyococcus irregularis</i>	3
45	<i>Vinciguerrria poweriae</i>	3
45	<i>Benthalbella dentata</i>	3
45	<i>Aristostomias scintillans</i>	3
45	<i>Sphyraena argentea</i>	3
58	<i>Cataetyx rubrirostris</i>	2
58	<i>Sebastes aurora</i>	2
58	<i>Scorpaena guttata</i>	2
58	<i>Bathophilus flemingi</i>	2
58	<i>Zaniolepis latipinnis</i>	2
58	<i>Scopelarchus analis</i>	2
58	<i>Howella</i> spp.	2
58	<i>Arctozenus risso</i>	2
58	<i>Paralabrax</i> spp.	2
58	Myctophidae	2
58	<i>Brama japonica</i>	2
58	Disintegrated fish larvae	2
58	<i>Hypsoblennius</i> spp.	2
58	<i>Pleuronichthys verticalis</i>	2
58	<i>Trachipterus altivelis</i>	2
58	<i>Seriphus politus</i>	2
58	<i>Oxyjulis californica</i>	2
75	<i>Cyema atrum</i>	1
75	<i>Oxylebius pictus</i>	1
75	<i>Lyopsetta exilis</i>	1
75	<i>Artedius lateralis</i>	1
75	<i>Xeneretmus latifrons</i>	1
75	<i>Xystreurys liolepis</i>	1
75	<i>Argyropelecus hemigymnus</i>	1
75	<i>Hippoglossina stomata</i>	1
75	<i>Atractoscion nobilis</i>	1
75	<i>Sebastes paucispinis</i>	1
75	<i>Melamphaes</i> spp.	1
75	<i>Nansenia candida</i>	1
75	<i>Glyptocephalus zachirus</i>	1
75	<i>Genyonemus lineatus</i>	1
75	<i>Icichthys lockingtoni</i>	1
75	<i>Hygophum atratum</i>	1
75	<i>Diogenichthys</i> spp.	1
75	<i>Hypsoblennius gilberti</i>	1
75	<i>Nemichthys scolopaceus</i>	1
75	<i>Plectobranthus evides</i>	1
75	<i>Nannobranchium hawaiiensis</i>	1
75	<i>Chilara taylori</i>	1
75	<i>Melamphaes parvus</i>	1
75	<i>Antennarius avalonis</i>	1
75	<i>Sebastes jordani</i>	1
75	Paralepididae	1
75	<i>Scopelosaurus</i> spp.	1
75	<i>Scopelarchus guentheri</i>	1

TABLE 6. (cont.)

Rank	Taxon	Occurrences
75	<i>Oneirodes</i> spp.	1
75	<i>Electrona risso</i>	1
75	<i>Tetragonurus cuvieri</i>	1
75	<i>Notolychnus valdiviae</i>	1
75	<i>Citharichthys</i> spp.	1
75	<i>Ophidion scrippsae</i>	1
	Total	715

TABLE 7. Pooled counts of fish larvae taken in Bongo net tows on the 1997 and 1998 Mini-CalCOFI survey cruises. Counts are adjusted for percent of sample sorted and standard haul factor (see text).

Rank	Taxon	Count
1	<i>Vinciguerria lucetia</i>	11523
2	<i>Engraulis mordax</i>	2361
3	<i>Sardinops sagax</i>	1617
4	<i>Triphoturus mexicanus</i>	1004
5	<i>Bathylagus wesethi</i>	927
6	<i>Ceratoscopelus townsendi</i>	813
7	<i>Sebastes</i> spp.	760
8	<i>Leuroglossus stilbius</i>	573
9	<i>Diogenichthys atlanticus</i>	524
10	<i>Stenobranchius leucopsarus</i>	515
11	<i>Cyclothone signata</i>	449
12	<i>Protomyctophum crockeri</i>	421
13	Disintegrated fish larvae	374
14	<i>Merluccius productus</i>	322
15	<i>Trachurus symmetricus</i>	243
16	<i>Scomber japonicus</i>	221
17	<i>Symbolophorus californiensis</i>	208
18	<i>Sphyræna argentea</i>	200
19	<i>Bathylagus ochotensis</i>	182
20	<i>Nannobranchium ritteri</i>	148
21	<i>Chromis punctipinnis</i>	117
22	<i>Idiacanthus antrostomus</i>	115
23	<i>Lestidiops ringens</i>	112
24	<i>Nannobranchium</i> spp.	110
25	<i>Vinciguerria poweriae</i>	77
26	<i>Citharichthys stigmaeus</i>	62
27	<i>Stomias atriventer</i>	55
28	<i>Chiasmodon niger</i>	54
29	<i>Citharichthys sordidus</i>	53
30	<i>Hypsoblennius jenkinsi</i>	52
31	<i>Hygophum reinhardtii</i>	50
32	<i>Argyropelecus sladeni</i>	46
33	<i>Diogenichthys laternatus</i>	42
34	<i>Sternoptyx</i> spp.	41
34	<i>Melamphaes lugubris</i>	41
36	<i>Paralabrax</i> spp.	40
37	<i>Seriphus politus</i>	38
38	<i>Bathylagus pacificus</i>	37
39	<i>Lyopsetta exilis</i>	35
39	<i>Sebastes diploproa</i>	35
41	<i>Tarletonbeania crenularis</i>	34
42	<i>Danaphos oculatus</i>	33
43	<i>Scopelogadus bispinosus</i>	31
44	<i>Argentina sialis</i>	30
44	<i>Rosenblattichthys volucris</i>	30
46	<i>Notoscopelus resplendens</i>	28
47	<i>Lampadena urophaos</i>	27
48	<i>Myctophum nitidulum</i>	26
49	<i>Argyropelecus affinis</i>	25
50	<i>Diaphus</i> spp.	24

TABLE 7. (cont.)

Rank	Taxon	Count
51	<i>Oxyjulis californica</i>	23
52	<i>Paralichthys californicus</i>	20
53	<i>Citharichthys</i> spp.	19
53	<i>Benthalbella dentata</i>	19
53	<i>Chauliodus macouni</i>	19
53	<i>Sebastes aurora</i>	19
53	<i>Nannobranchium regale</i>	19
53	<i>Microstoma</i> spp.	19
59	<i>Poromitra crassiceps</i>	18
60	<i>Coryphopterus nicholsii</i>	15
60	<i>Argyropelecus lychnus</i>	15
62	<i>Ichthyococcus irregularis</i>	14
62	<i>Trachipterus altivelis</i>	14
64	<i>Lampanyctus steinbecki</i>	13
64	<i>Aristostomias scintillans</i>	13
64	<i>Arctozenus risso</i>	13
67	<i>Chilara taylori</i>	11
68	<i>Notolychnus valdiviae</i>	10
68	<i>Hypsoblennius</i> spp.	10
68	<i>Glyptocephalus zachirus</i>	10
68	Myctophidae	10
68	<i>Howella</i> spp.	10
68	<i>Scorpaena guttata</i>	10
74	<i>Plectobranchnus evides</i>	9
74	<i>Sebastes jordani</i>	9
74	<i>Oxylebius pictus</i>	9
74	<i>Oneirodes</i> spp.	9
74	<i>Scopelarchus analis</i>	9
79	<i>Cataetyx rubrirostris</i>	8
79	<i>Brama japonica</i>	8
79	<i>Zaniolepis latipinnis</i>	8
79	<i>Sebastes paucispinis</i>	8
79	<i>Pleuronichthys verticalis</i>	8
79	<i>Bathophilus flemingi</i>	8
79	<i>Hypsoblennius gilberti</i>	8
86	<i>Nansenia candida</i>	5
86	<i>Atractoscion nobilis</i>	5
86	<i>Hippoglossina stomata</i>	5
86	<i>Argyropelecus hemigymnus</i>	5
86	<i>Cyema atrum</i>	5
86	<i>Hygophum atratum</i>	5
86	<i>Icichthys lockingtoni</i>	5
86	<i>Electrona risso</i>	5
86	<i>Diogenichthys</i> spp.	5
95	<i>Antennarius avalonis</i>	4
95	Paralepididae	4
95	<i>Genyonemus lineatus</i>	4
95	<i>Xeneretmus latifrons</i>	4
95	<i>Nannobranchium hawaiiensis</i>	4
95	<i>Artedius lateralis</i>	4
95	<i>Scopelosaurus</i> spp.	4
95	<i>Melamphaes parvus</i>	4

TABLE 7. (cont.)

Rank	Taxon	Count
95	<i>Melamphaes</i> spp.	4
95	<i>Scopelarchus guentheri</i>	4
95	<i>Tetragonurus cuvieri</i>	4
95	<i>Nemichthys scolopaceus</i>	4
107	<i>Ophidion scrippsae</i>	3
107	<i>Xystreureys liolepis</i>	3
	Total	25428

TABLE 8. Number of fish larvae taken in Bongo net tows at stations occupied on the 1997 and 1998 Mini-CalCOFI survey cruises. Counts are adjusted for percent of sample sorted and standard haul factor (see text). Unoccupied stations are indicated by a dash.

Station	'97 Dec.	'98 Mar.	May	June	Aug.	Oct.	Nov.	Dec.
<i>Nemichthys scolopaceus</i>								
90.0 100.0	-	-	0.0	0.0	4.3	-	-	0.0
<i>Cyema atrum</i>								
83.3 70.0	-	-	-	4.6	-	0.0	0.0	-
<i>Sardinops sagax</i>								
83.3 42.0	-	32.5	0.0	0.0	0.0	0.0	0.0	0.0
83.3 51.0	-	-	8.9	0.0	0.0	0.0	0.0	0.0
90.0 28.0	0.0	122.1	0.0	0.0	0.0	0.0	0.0	0.0
90.0 30.0	0.0	91.2	0.0	0.0	0.0	0.0	0.0	0.0
90.0 35.0	0.0	89.2	8.9	0.0	0.0	0.0	0.0	0.0
90.0 37.0	0.0	18.9	0.0	0.0	0.0	0.0	0.0	0.0
90.0 45.0	0.0	780.7	0.0	0.0	-	0.0	0.0	0.0
90.0 53.0	0.0	25.1	-	0.0	0.0	0.0	0.0	0.0
90.0 60.0	0.0	435.9	-	0.0	0.0	0.0	-	0.0
90.0 70.0	0.0	4.5	-	0.0	0.0	-	-	0.0
<i>Engraulis mordax</i>								
83.3 40.6	-	-	4.3	0.0	114.4	9.0	3.7	0.0
83.3 42.0	-	62.0	40.5	0.0	475.7	24.6	12.6	0.0
83.3 51.0	-	-	26.6	0.0	33.7	0.0	11.4	0.0
83.3 55.0	-	-	-	0.0	6.4	8.9	0.0	-
83.3 60.0	-	-	-	0.0	0.0	0.0	7.8	-
90.0 28.0	33.5	215.4	19.1	37.7	20.6	96.6	468.6	43.0
90.0 30.0	0.0	62.4	0.0	5.0	0.0	33.0	144.2	127.0
90.0 35.0	0.0	22.3	17.8	9.9	7.6	4.7	0.0	0.0
90.0 37.0	0.0	28.3	0.0	38.3	0.0	0.0	0.0	17.6
90.0 45.0	0.0	9.0	46.5	0.0	-	0.0	0.0	0.0
90.0 53.0	0.0	0.0	-	0.0	0.0	0.0	0.0	0.0
90.0 60.0	0.0	4.8	-	0.0	0.0	0.0	0.0	5.1
								0.0

TABLE 8. (cont.)

	<i>Argentina sialis</i>											
Station						June						
83.3 42.0				May		0.0	Aug.	Oct.	Nov.	Dec.		
90.0 35.0	'97 Dec.	'98 Mar.		10.1	0.0	0.0	0.0	0.0	0.0	8.3		
90.0 45.0	0.0	3.0		0.0	0.0	0.0	0.0	0.0	0.0	0.0		
	0.0	4.5		4.7	0.0	0.0	-	0.0	0.0	0.0		
	0.0	0.0			0.0							
			<i>Microstoma spp.</i>									
Station						June						
83.3 80.0	'97 Dec.	'98 Mar.		May		0.0	Aug.	Oct.	Nov.	Dec.		
90.0 60.0	-	-		-	0.0	0.0	0.0	0.0	4.5	-		
90.0 70.0	3.9	4.8		-	0.0	0.0	0.0	0.0	-	0.0		
	0.0	0.0		-	0.0		4.9	-	-	0.0		
			<i>Nansenia candida</i>									
Station						June						
90.0 70.0	'97 Dec.	'98 Mar.		May		0.0	Aug.	Oct.	Nov.	Dec.		
	-	0.0		-	0.0		4.9	-	-	0.0		
			<i>Bathylagus ochotensis</i>									
Station						June						
83.3 42.0	'97 Dec.	'98 Mar.		May		0.0	Aug.	Oct.	Nov.	Dec.		
83.3 51.0	-	0.0		10.1	0.0	0.0	0.0	0.0	0.0	0.0		
83.3 70.0	-	-		8.9	9.3	0.0	0.0	0.0	0.0	0.0		
90.0 30.0	-	-		-	4.6	-	-	0.0	0.0	-		
90.0 35.0	0.0	0.0		0.0	10.1	0.0	0.0	0.0	0.0	0.0		
90.0 37.0	0.0	0.0		8.9	19.7	0.0	0.0	0.0	0.0	0.0		
90.0 45.0	0.0	0.0		9.5	9.6	0.0	7.4	0.0	0.0	0.0		
90.0 60.0	0.0	44.9		4.7	0.0	0.0	-	0.0	0.0	8.5		
90.0 70.0	0.0	4.8		-	10.0	0.0	0.0	0.0	-	0.0		
	0.0	8.9		-	0.0		0.0	-	-	0.0		
			<i>Bathylagus pacificus</i>									
Station						June						
90.0 45.0	'97 Dec.	'98 Mar.		May		0.0	Aug.	Oct.	Nov.	Dec.		
90.0 53.0	0.0	26.9		0.0	0.0	0.0	-	0.0	0.0	0.0		
90.0 80.0	0.0	5.0		-	0.0	0.0	0.0	0.0	0.0	0.0		
	0.0	0.0		0.0	4.6		0.0	0.0	-	0.0		
			<i>Bathylagus wesethi</i>									
Station						June						
83.3 60.0	'97 Dec.	'98 Mar.		May		0.0	Aug.	Oct.	Nov.	Dec.		
83.3 80.0	-	-		-	0.0	0.0	7.4	0.0	0.0	-		
83.3 90.0	-	-		-	181.7		31.5	0.0	0.0	-		
83.3 100.0	-	-		-	0.0		4.7	0.0	0.0	-		
90.0 35.0	-	-		-	4.3		4.8	-	0.0	0.0		
90.0 53.0	0.0	0.0		4.5	0.0	0.0	0.0	0.0	0.0	0.0		
	5.2	5.0		-	0.0		0.0	0.0	0.0	0.0		

TABLE 8. (cont.)

<i>Bathylagus wesethi</i> (cont.)									
Station	'97 Dec.	'98 Mar.	May	June	Aug.	Oct.	Nov.	Dec.	
90.0 60.0	7.7	28.7	-	50.2	155.4	0.0	-	0.0	
90.0 70.0	0.0	40.2	-	85.0	111.6	-	-	0.0	
90.0 80.0	0.0	12.0	9.1	9.3	160.2	0.0	-	0.0	
90.0 90.0	-	0.0	-	0.0	4.8	-	-	0.0	
90.0 100.0	-	-	0.0	0.0	4.3	-	-	0.0	
<i>Leuroglossus stilbius</i>									
Station	'97 Dec.	'98 Mar.	May	June	Aug.	Oct.	Nov.	Dec.	
83.3 42.0	-	3.0	0.0	0.0	0.0	6.1	0.0	0.0	
83.3 60.0	-	-	-	0.0	0.0	4.3	0.0	-	
83.3 90.0	-	-	-	0.0	0.0	18.6	0.0	-	
90.0 28.0	0.0	3.6	4.8	0.0	0.0	0.0	0.0	0.0	
90.0 30.0	0.0	72.0	15.5	0.0	0.0	0.0	0.0	0.0	
90.0 35.0	0.0	165.0	13.4	4.9	0.0	0.0	0.0	8.8	
90.0 37.0	0.0	37.8	0.0	0.0	0.0	0.0	0.0	0.0	
90.0 45.0	0.0	71.8	9.3	0.0	-	0.0	0.0	0.0	
90.0 53.0	0.0	105.2	-	0.0	0.0	0.0	0.0	0.0	
90.0 60.0	0.0	0.0	-	0.0	0.0	0.0	-	20.3	
90.0 80.0	0.0	0.0	9.1	0.0	0.0	0.0	-	0.0	
<i>Cyclothone signata</i>									
Station	'97 Dec.	'98 Mar.	May	June	Aug.	Oct.	Nov.	Dec.	
83.3 80.0	-	-	-	33.0	13.5	4.7	13.5	-	
83.3 90.0	-	-	-	9.4	4.7	9.3	0.0	-	
83.3 100.0	-	-	-	4.3	24.0	-	4.6	14.3	
90.0 35.0	5.1	0.0	4.5	0.0	0.0	0.0	0.0	0.0	
90.0 37.0	4.9	0.0	0.0	0.0	0.0	0.0	0.0	0.0	
90.0 45.0	5.1	0.0	0.0	0.0	-	0.0	0.0	0.0	
90.0 53.0	0.0	20.0	-	0.0	0.0	0.0	0.0	0.0	
90.0 60.0	3.9	14.4	-	5.0	9.4	4.7	-	0.0	
90.0 70.0	12.4	40.2	-	42.5	4.9	-	-	0.0	
90.0 80.0	0.0	8.0	4.6	13.9	0.0	0.0	-	4.5	
90.0 90.0	-	18.1	-	9.8	0.0	-	-	14.0	
90.0 100.0	-	-	4.4	9.3	43.1	-	-	7.7	
<i>Argyropelecus affinis</i>									
Station	'97 Dec.	'98 Mar.	May	June	Aug.	Oct.	Nov.	Dec.	
90.0 60.0	0.0	9.6	-	10.0	0.0	0.0	-	0.0	
90.0 90.0	-	0.0	-	0.0	4.8	-	-	0.0	

TABLE 8. (cont.)

Station														
90.0	60.0	'97 Dec.	'98 Mar.	May	June	Aug.	Oct.	Nov.	Dec.					
		0.0	4.8	-	0.0	0.0	0.0	-	0.0					
<i>Argyropelecus hemigymnus</i>														
Station														
83.3	80.0	'97 Dec.	'98 Mar.	May	June	Aug.	Oct.	Nov.	Dec.					
		-	-	-	0.0	4.5	0.0	0.0	-					
83.3	100.0	-	-	-	0.0	0.0	-	0.0	4.8					
90.0	53.0	0.0	0.0	-	0.0	0.0	4.9	0.0	0.0					
<i>Argyropelecus tychnus</i>														
Station														
83.3	100.0	'97 Dec.	'98 Mar.	May	June	Aug.	Oct.	Nov.	Dec.					
		-	-	-	0.0	4.8	-	0.0	0.0					
90.0	37.0	4.9	0.0	0.0	0.0	0.0	0.0	0.0	0.0					
90.0	45.0	5.1	0.0	0.0	0.0	-	0.0	0.0	0.0					
90.0	53.0	0.0	0.0	-	0.0	0.0	0.0	0.0	5.1					
90.0	70.0	0.0	4.5	-	0.0	4.9	-	-	0.0					
90.0	90.0	-	0.0	-	0.0	0.0	-	-	9.3					
90.0	100.0	-	-	0.0	0.0	4.3	-	-	3.9					
<i>Argyropelecus sladeni</i>														
Station														
83.3	60.0	'97 Dec.	'98 Mar.	May	June	Aug.	Oct.	Nov.	Dec.					
		-	-	-	0.0	0.0	-	0.0	0.0					
90.0	45.0	0.0	9.0	0.0	0.0	-	0.0	0.0	0.0					
90.0	60.0	0.0	4.8	-	0.0	0.0	0.0	-	0.0					
90.0	70.0	0.0	8.9	-	0.0	0.0	-	-	0.0					
<i>Danaphos oculatus</i>														
Station														
83.3	60.0	'97 Dec.	'98 Mar.	May	June	Aug.	Oct.	Nov.	Dec.					
		-	-	-	10.5	0.0	0.0	0.0	-					
90.0	45.0	0.0	9.0	0.0	0.0	-	0.0	0.0	0.0					
90.0	60.0	0.0	4.8	-	0.0	0.0	0.0	-	0.0					
90.0	70.0	0.0	8.9	-	0.0	0.0	-	-	0.0					
<i>Sternoptyx spp.</i>														
Station														
83.3	70.0	'97 Dec.	'98 Mar.	May	June	Aug.	Oct.	Nov.	Dec.					
		-	-	-	4.6	-	0.0	0.0	-					
83.3	80.0	-	-	-	8.3	0.0	0.0	0.0	-					
90.0	28.0	0.0	3.6	0.0	0.0	0.0	0.0	0.0	0.0					
90.0	37.0	4.9	0.0	0.0	0.0	0.0	0.0	0.0	0.0					
90.0	53.0	0.0	10.0	-	0.0	0.0	0.0	0.0	0.0					
90.0	60.0	0.0	0.0	-	0.0	4.7	0.0	-	0.0					
90.0	90.0	-	3.6	-	0.0	0.0	-	-	0.0					
<i>Ichthyococcus irregularis</i>														
Station														
90.0	60.0	'97 Dec.	'98 Mar.	May	June	Aug.	Oct.	Nov.	Dec.					
		0.0	0.0	-	0.0	4.7	0.0	-	0.0					
90.0	90.0	-	0.0	-	4.9	0.0	-	-	0.0					
90.0	100.0	-	-	0.0	0.0	4.3	-	-	0.0					

TABLE 8. (cont.)

		<i>Vinciguerria lucetia</i>									
Station		'97 Dec.	'98 Mar.	May	June	Aug.	Oct.	Nov.	Dec.		
83.3	42.0	-	0.0	0.0	0.0	4.7	0.0	0.0	0.0		
83.3	70.0	-	-	-	9.1	-	0.0	0.0	-		
83.3	80.0	-	-	-	1656.1	540.0	0.0	0.0	-		
83.3	90.0	-	-	-	697.1	851.8	0.0	0.0	-		
83.3	100.0	-	-	-	94.8	699.3	-	29.9	-		
90.0	30.0	26.1	0.0	0.0	0.0	0.0	0.0	9.1	4.8		
90.0	35.0	0.0	0.0	0.0	0.0	7.6	0.0	0.0	0.0		
90.0	37.0	4.9	0.0	0.0	0.0	0.0	0.0	4.5	0.0		
90.0	45.0	0.0	9.0	0.0	0.0	-	0.0	0.0	0.0		
90.0	53.0	15.5	0.0	-	0.0	0.0	0.0	9.8	0.0		
90.0	60.0	81.3	38.3	-	105.4	409.8	32.6	-	0.0		
90.0	70.0	16.5	134.1	-	221.8	358.9	-	-	0.0		
90.0	80.0	0.0	16.0	269.6	1169.3	369.4	0.0	-	14.4		
90.0	90.0	-	39.7	-	965.3	761.6	-	-	0.0		
90.0	100.0	-	-	500.3	50.9	1288.7	-	-	4.7		
		<i>Vinciguerria poweriae</i>									
Station		'97 Dec.	'98 Mar.	May	June	Aug.	Oct.	Nov.	Dec.		
83.3	80.0	-	-	-	49.6	0.0	0.0	0.0	-		
90.0	80.0	0.0	4.0	0.0	0.0	0.0	0.0	-	0.0		
90.0	90.0	-	0.0	-	0.0	0.0	-	-	23.3		
		<i>Chauliodus macouni</i>									
Station		'97 Dec.	'98 Mar.	May	June	Aug.	Oct.	Nov.	Dec.		
83.3	80.0	-	-	-	4.1	0.0	0.0	0.0	-		
90.0	35.0	0.0	0.0	0.0	4.9	0.0	0.0	0.0	0.0		
90.0	53.0	0.0	0.0	-	0.0	0.0	0.0	0.0	5.1		
90.0	100.0	-	-	0.0	4.6	0.0	-	-	0.0		
		<i>Stomias atriventer</i>									
Station		'97 Dec.	'98 Mar.	May	June	Aug.	Oct.	Nov.	Dec.		
83.3	80.0	-	-	-	4.1	4.5	0.0	0.0	-		
83.3	100.0	-	-	-	0.0	4.8	-	0.0	0.0		
90.0	35.0	0.0	4.5	0.0	0.0	0.0	0.0	0.0	0.0		
90.0	53.0	0.0	5.0	-	0.0	0.0	0.0	0.0	0.0		
90.0	60.0	3.9	4.8	-	0.0	0.0	0.0	-	0.0		
90.0	70.0	0.0	8.9	-	0.0	0.0	-	-	0.0		
90.0	80.0	0.0	0.0	4.6	4.6	4.5	0.0	-	0.0		

TABLE 8. (cont.)

Station	'97 Dec.	'98 Mar.	May	June	Aug.	Oct.	Nov.	Dec.
				<i>Bathophilus flemingi</i>				
83.3 80.0	-	-	-	4.1	0.0	0.0	0.0	-
90.0 80.0	0.0	0.0	0.0	0.0	4.5	0.0	-	0.0
				<i>Aristostomias scintillans</i>				
Station	'97 Dec.	'98 Mar.	May	June	Aug.	Oct.	Nov.	Dec.
90.0 60.0	0.0	4.8	-	0.0	0.0	0.0	-	0.0
90.0 70.0	0.0	4.5	-	0.0	0.0	-	-	0.0
90.0 90.0	-	3.6	-	0.0	0.0	-	-	0.0
				<i>Idiacanthus antrostomus</i>				
Station	'97 Dec.	'98 Mar.	May	June	Aug.	Oct.	Nov.	Dec.
83.3 80.0	-	-	-	20.7	0.0	32.6	4.5	-
83.3 90.0	-	-	-	0.0	4.7	9.3	5.0	-
90.0 70.0	0.0	0.0	-	0.0	9.7	-	-	0.0
90.0 80.0	0.0	0.0	0.0	9.3	8.9	0.0	-	0.0
90.0 90.0	-	0.0	-	0.0	4.8	-	-	0.0
90.0 100.0	-	-	0.0	0.0	0.0	-	-	3.9
				<i>Benthalbella dentata</i>				
Station	'97 Dec.	'98 Mar.	May	June	Aug.	Oct.	Nov.	Dec.
83.3 100.0	-	-	-	0.0	4.8	-	0.0	0.0
90.0 53.0	0.0	0.0	-	9.9	0.0	0.0	0.0	0.0
90.0 90.0	-	3.6	-	0.0	0.0	-	-	0.0
				<i>Rosenblattichthys volucris</i>				
Station	'97 Dec.	'98 Mar.	May	June	Aug.	Oct.	Nov.	Dec.
83.3 80.0	-	-	-	12.4	0.0	4.7	0.0	-
90.0 60.0	7.7	0.0	-	0.0	0.0	0.0	-	0.0
90.0 90.0	-	0.0	-	0.0	4.8	-	-	0.0
				<i>Scopelarchus analis</i>				
Station	'97 Dec.	'98 Mar.	May	June	Aug.	Oct.	Nov.	Dec.
83.3 100.0	-	-	-	0.0	0.0	-	0.0	0.0
90.0 60.0	3.9	0.0	-	0.0	0.0	0.0	4.6	0.0
				<i>Scopelarchus guentheri</i>				
Station	'97 Dec.	'98 Mar.	May	June	Aug.	Oct.	Nov.	Dec.
83.3 80.0	-	-	-	4.1	0.0	0.0	0.0	-
				<i>Scopelosaurus</i> spp.				
Station	'97 Dec.	'98 Mar.	May	June	Aug.	Oct.	Nov.	Dec.
90.0 70.0	0.0	4.5	-	0.0	0.0	-	-	0.0

TABLE 8. (cont.)

Station	'97 Dec.	'98 Mar.	May	June	Aug.	Oct.	Nov.	Dec.
90.0 70.0	0.0	4.5	-	0.0	0.0	-	-	0.0
Paralepididae								
Station	'97 Dec.	'98 Mar.	May	June	Aug.	Oct.	Nov.	Dec.
90.0 70.0	0.0	0.0	-	0.0	-	0.0	8.2	-
Arctozenus risso								
90.0 70.0	0.0	0.0	-	4.7	0.0	-	-	0.0
Lestidiops ringens								
Station	'97 Dec.	'98 Mar.	May	June	Aug.	Oct.	Nov.	Dec.
83.3 55.0	-	-	-	0.0	0.0	0.0	7.8	-
83.3 60.0	-	-	-	0.0	7.4	0.0	0.0	-
83.3 80.0	-	-	-	8.3	4.5	9.3	0.0	-
90.0 37.0	0.0	0.0	0.0	0.0	7.4	0.0	0.0	0.0
90.0 53.0	0.0	0.0	-	0.0	0.0	4.9	0.0	0.0
90.0 60.0	0.0	9.6	-	20.1	14.1	0.0	-	0.0
90.0 70.0	0.0	4.5	-	4.7	4.9	-	-	0.0
90.0 100.0	-	-	0.0	4.6	0.0	-	-	0.0
Myctophidae								
Station	'97 Dec.	'98 Mar.	May	June	Aug.	Oct.	Nov.	Dec.
83.3 100.0	-	-	-	0.0	4.8	-	0.0	0.0
90.0 90.0	-	0.0	-	4.9	0.0	-	-	0.0
Ceratoscopelus townsendi								
Station	'97 Dec.	'98 Mar.	May	June	Aug.	Oct.	Nov.	Dec.
83.3 70.0	-	-	-	4.6	-	0.0	0.0	-
83.3 80.0	-	-	-	74.3	18.0	0.0	4.5	-
83.3 90.0	-	-	-	75.4	42.1	0.0	5.0	-
83.3 100.0	-	-	-	25.9	38.3	-	13.7	0.0
90.0 30.0	0.0	4.8	0.0	0.0	0.0	0.0	0.0	0.0
90.0 35.0	0.0	4.5	0.0	0.0	0.0	0.0	0.0	0.0
90.0 60.0	0.0	4.8	-	75.3	4.7	0.0	-	0.0
90.0 70.0	8.2	13.4	-	14.2	19.4	-	-	0.0
90.0 80.0	0.0	23.9	0.0	37.1	0.0	0.0	-	0.0
90.0 90.0	-	25.3	-	58.8	14.3	-	-	4.7
90.0 100.0	-	-	8.7	0.0	189.6	-	-	0.0
Diaphus spp.								
Station	'97 Dec.	'98 Mar.	May	June	Aug.	Oct.	Nov.	Dec.
83.3 60.0	-	-	-	0.0	14.7	0.0	0.0	-

TABLE 8. (cont.)

Station	'97 Dec.	'98 Mar.	May	<i>Diaphus</i> spp. (cont.)		Aug.	Oct.	Nov.	Dec.
83.3 80.0	-	-	-	June	4.1	0.0	0.0	0.0	-
83.3 90.0	-	-	-	June	0.0	0.0	4.7	0.0	-
Station				<i>Lampadena urophaos</i>					
83.3 90.0	'97 Dec.	'98 Mar.	May	June	0.0	4.7	0.0	Nov.	Dec.
83.3 100.0	-	-	-	0.0	4.8	4.8	-	0.0	-
90.0 60.0	3.9	0.0	-	0.0	4.8	0.0	-	0.0	0.0
90.0 100.0	-	-	0.0	0.0	0.0	0.0	0.0	-	0.0
Station				<i>Lampanyctus steinbecki</i>					
83.3 90.0	'97 Dec.	'98 Mar.	May	June		Aug.	Oct.	Nov.	Dec.
90.0 90.0	-	-	-	0.0		0.0	0.0	5.0	-
90.0 100.0	-	3.6	-	0.0		0.0	-	-	0.0
			4.4	0.0		0.0	-	-	0.0
Station				<i>Nannobranchium</i> spp.					
83.3 80.0	'97 Dec.	'98 Mar.	May	June		Aug.	Oct.	Nov.	Dec.
90.0 30.0	-	-	-	8.3		0.0	0.0	0.0	-
90.0 35.0	0.0	0.0	0.0	0.0		5.2	0.0	0.0	0.0
90.0 53.0	5.2	20.0	-	9.9		0.0	0.0	0.0	0.0
90.0 70.0	0.0	4.5	-	14.2		0.0	-	-	0.0
90.0 90.0	-	7.2	-	14.7		0.0	-	-	9.3
90.0 100.0	-	-	0.0	4.6		0.0	-	-	3.9
Station				<i>Nannobranchium hawaiiensis</i>					
90.0 100.0	'97 Dec.	'98 Mar.	May	June		Aug.	Oct.	Nov.	Dec.
	-	-	4.4	0.0		0.0	-	-	0.0
Station				<i>Nannobranchium regale</i>					
90.0 45.0	'97 Dec.	'98 Mar.	May	June		Aug.	Oct.	Nov.	Dec.
90.0 60.0	0.0	0.0	4.7	0.0		-	0.0	0.0	0.0
90.0 70.0	3.9	0.0	-	0.0		0.0	0.0	-	0.0
	0.0	0.0	-	0.0		9.7	-	-	0.0
Station				<i>Nannobranchium ritteri</i>					
83.3 60.0	'97 Dec.	'98 Mar.	May	June		Aug.	Oct.	Nov.	Dec.
83.3 70.0	-	-	-	10.5		0.0	0.0	0.0	-
83.3 100.0	-	-	-	4.6		-	0.0	0.0	-
	-	-	-	0.0		0.0	-	4.6	0.0

TABLE 8. (cont.)

<i>Nannobranchium ritteri</i> (cont.)									
Station	'97 Dec.	'98 Mar.	May	June	Aug.	Oct.	Nov.	Dec.	
90.0 30.0	5.2	0.0	0.0	15.1	0.0	0.0	0.0	0.0	
90.0 35.0	5.1	0.0	8.9	0.0	0.0	0.0	0.0	0.0	
90.0 53.0	0.0	5.0	-	0.0	0.0	0.0	0.0	0.0	
90.0 60.0	0.0	9.6	-	25.1	14.1	0.0	-	10.1	
90.0 70.0	0.0	8.9	-	0.0	0.0	-	-	0.0	
90.0 80.0	0.0	8.0	0.0	0.0	8.9	0.0	-	0.0	
90.0 100.0	-	-	0.0	0.0	4.3	-	-	0.0	
<i>Notolichnus valdiviae</i>									
Station	'97 Dec.	'98 Mar.	May	June	Aug.	Oct.	Nov.	Dec.	
83.3 100.0	-	-	-	0.0	0.0	-	0.0	9.5	
<i>Notoscopelus resplendens</i>									
Station	'97 Dec.	'98 Mar.	May	June	Aug.	Oct.	Nov.	Dec.	
83.3 80.0	-	-	-	8.3	0.0	0.0	0.0	-	
83.3 100.0	-	-	-	0.0	4.8	-	0.0	0.0	
90.0 60.0	0.0	0.0	-	0.0	0.0	4.7	-	0.0	
90.0 90.0	-	0.0	-	4.9	4.8	-	-	0.0	
<i>Stenobranchius leucoparus</i>									
Station	'97 Dec.	'98 Mar.	May	June	Aug.	Oct.	Nov.	Dec.	
83.3 40.6	-	-	4.3	0.0	0.0	0.0	0.0	0.0	
83.3 42.0	-	0.0	121.5	17.7	0.0	0.0	0.0	0.0	
83.3 51.0	-	-	17.7	55.8	0.0	0.0	0.0	0.0	
83.3 60.0	-	-	-	21.0	0.0	0.0	0.0	-	
83.3 70.0	-	-	-	9.1	-	0.0	0.0	-	
90.0 28.0	0.0	18.0	0.0	4.7	0.0	0.0	0.0	0.0	
90.0 30.0	0.0	14.4	5.2	15.1	0.0	0.0	0.0	0.0	
90.0 35.0	0.0	17.8	22.3	0.0	0.0	0.0	0.0	0.0	
90.0 37.0	0.0	9.4	0.0	9.6	0.0	0.0	0.0	0.0	
90.0 45.0	0.0	98.7	4.7	19.2	-	0.0	0.0	0.0	
90.0 53.0	0.0	20.0	-	0.0	0.0	0.0	0.0	0.0	
90.0 60.0	0.0	4.8	-	0.0	0.0	0.0	0.0	0.0	
90.0 70.0	0.0	4.5	-	0.0	0.0	-	-	0.0	
<i>Triphoturus mexicanus</i>									
Station	'97 Dec.	'98 Mar.	May	June	Aug.	Oct.	Nov.	Dec.	
83.3 40.6	-	-	0.0	0.0	2.7	0.0	0.0	0.0	
83.3 42.0	-	0.0	0.0	0.0	4.7	6.1	0.0	0.0	

TABLE 8. (cont.)

		<i>Triphoturus mexicanus</i> (cont.)									
Station		'97 Dec.	'98 Mar.	May	June	Aug.	Oct.	Nov.	Dec.		
83.3	51.0	-	-	0.0	0.0	9.6	0.0	0.0	0.0		
83.3	55.0	-	-	-	0.0	12.8	8.9	7.8	-		
83.3	60.0	-	-	-	42.0	0.0	0.0	0.0	-		
83.3	70.0	-	-	-	4.6	-	4.5	0.0	-		
83.3	80.0	-	-	-	86.7	22.5	0.0	0.0	-		
83.3	90.0	-	-	-	18.8	14.0	0.0	0.0	-		
83.3	100.0	-	-	-	0.0	9.6	-	0.0	0.0		
90.0	28.0	0.0	3.6	0.0	4.7	0.0	0.0	0.0	0.0		
90.0	30.0	0.0	0.0	0.0	40.2	0.0	18.8	0.0	0.0		
90.0	35.0	0.0	0.0	0.0	0.0	22.7	0.0	18.0	0.0		
90.0	37.0	0.0	0.0	0.0	0.0	29.6	9.4	0.0	0.0		
90.0	53.0	0.0	0.0	-	0.0	0.0	9.7	0.0	0.0		
90.0	60.0	0.0	24.0	-	65.3	84.8	0.0	-	0.0		
90.0	70.0	0.0	8.9	-	85.0	53.4	-	-	0.0		
90.0	80.0	0.0	0.0	22.9	23.2	31.2	0.0	-	0.0		
90.0	90.0	-	7.2	-	117.6	28.6	-	-	0.0		
90.0	100.0	-	-	13.1	4.6	17.2	-	-	0.0		
<i>Diogenichthys</i> spp.											
Station		'97 Dec.	'98 Mar.	May	June	Aug.	Oct.	Nov.	Dec.		
90.0	37.0	0.0	4.7	0.0	0.0	0.0	0.0	0.0	0.0		
<i>Diogenichthys atlanticus</i>											
Station		'97 Dec.	'98 Mar.	May	June	Aug.	Oct.	Nov.	Dec.		
83.3	55.0	-	-	-	0.0	0.0	0.0	7.8	-		
83.3	70.0	-	-	-	0.0	-	0.0	8.2	-		
83.3	80.0	-	-	-	45.4	40.5	4.7	0.0	-		
83.3	90.0	-	-	-	4.7	4.7	0.0	25.0	-		
83.3	100.0	-	-	-	4.3	24.0	-	4.6	19.1		
90.0	35.0	0.0	4.5	13.4	0.0	0.0	0.0	0.0	0.0		
90.0	45.0	0.0	0.0	0.0	0.0	-	0.0	8.8	0.0		
90.0	53.0	0.0	0.0	-	0.0	0.0	4.9	9.8	0.0		
90.0	60.0	3.9	14.4	-	30.1	33.0	14.0	-	0.0		
90.0	70.0	12.4	35.8	-	37.8	9.7	-	-	9.6		
90.0	80.0	0.0	8.0	0.0	0.0	13.4	0.0	-	13.5		
90.0	90.0	-	7.2	-	0.0	9.5	-	-	23.3		
90.0	100.0	-	-	0.0	4.6	4.3	-	-	3.9		

TABLE 8. (cont.)

<i>Diogenichthys laternatus</i>											
Station											
90.0	35.0	'97 Dec.	'98 Mar.	May	June	Aug.	Oct.	Nov.	Dec.		
		10.2	4.5	0.0	0.0	0.0	0.0	0.0	0.0		
90.0	37.0	14.6	0.0	0.0	0.0	0.0	4.7	0.0	0.0		
90.0	60.0	7.7	0.0	-	0.0	0.0	0.0	-	0.0		
<i>Electrona risso</i>											
Station											
83.3	80.0	'97 Dec.	'98 Mar.	May	June	Aug.	Oct.	Nov.	Dec.		
		-	-	-	0.0	4.5	0.0	0.0	-		
<i>Hygophum atratum</i>											
Station											
90.0	30.0	'97 Dec.	'98 Mar.	May	June	Aug.	Oct.	Nov.	Dec.		
		5.2	0.0	0.0	0.0	0.0	0.0	0.0	0.0		
<i>Hygophum reinhardtii</i>											
Station											
83.3	80.0	'97 Dec.	'98 Mar.	May	June	Aug.	Oct.	Nov.	Dec.		
		-	-	-	4.1	0.0	0.0	0.0	-		
83.3	90.0	-	-	-	9.4	4.7	9.3	0.0	-		
83.3	100.0	-	-	-	0.0	0.0	-	0.0	4.8		
90.0	60.0	3.9	0.0	-	0.0	4.7	0.0	-	0.0		
90.0	70.0	0.0	4.5	-	0.0	0.0	-	-	0.0		
90.0	90.0	-	0.0	-	0.0	4.8	-	-	0.0		
<i>Myctophum nitidulum</i>											
Station											
83.3	80.0	'97 Dec.	'98 Mar.	May	June	Aug.	Oct.	Nov.	Dec.		
		-	-	-	4.1	0.0	0.0	0.0	-		
83.3	90.0	-	-	-	4.7	0.0	0.0	0.0	-		
83.3	100.0	-	-	-	0.0	0.0	-	0.0	4.8		
90.0	60.0	3.9	0.0	-	0.0	0.0	0.0	-	0.0		
90.0	70.0	0.0	4.5	-	0.0	0.0	-	-	0.0		
90.0	90.0	-	3.6	-	0.0	0.0	-	-	0.0		
<i>Protonyctophum crockeri</i>											
Station											
83.3	60.0	'97 Dec.	'98 Mar.	May	June	Aug.	Oct.	Nov.	Dec.		
		-	-	-	0.0	22.1	4.3	0.0	-		
83.3	80.0	-	-	-	20.7	0.0	9.3	0.0	-		
83.3	90.0	-	-	-	0.0	4.7	9.3	5.0	-		
83.3	100.0	-	-	-	0.0	9.6	-	0.0	14.3		
90.0	30.0	0.0	0.0	0.0	0.0	0.0	4.7	15.5	10.2		
90.0	35.0	10.2	8.9	0.0	0.0	0.0	0.0	0.0	0.0		
90.0	37.0	4.9	14.2	4.8	0.0	0.0	4.7	0.0	8.8		
90.0	45.0	0.0	0.0	0.0	0.0	-	0.0	0.0	25.6		

TABLE 8. (cont.)

		<i>Protomyctophum crockeri</i> (cont.)															
Station	'97 Dec.	'98 Mar.	May	June	Aug.	Oct.	Nov.	Dec.	Station	'97 Dec.	'98 Mar.	May	June	Aug.	Oct.	Nov.	Dec.
90.0 53.0	15.5	0.0	-	0.0	0.0	4.9	19.5	30.8	90.0 53.0	15.5	0.0	-	0.0	0.0	4.9	19.5	30.8
90.0 60.0	7.7	14.4	-	5.0	4.7	9.3	-	30.4	90.0 60.0	7.7	14.4	-	5.0	4.7	9.3	-	30.4
90.0 70.0	12.4	8.9	-	4.7	4.9	-	-	4.8	90.0 70.0	12.4	8.9	-	4.7	4.9	-	-	4.8
90.0 80.0	0.0	0.0	9.1	0.0	0.0	0.0	-	0.0	90.0 80.0	0.0	0.0	9.1	0.0	0.0	0.0	-	0.0
90.0 100.0	-	-	4.4	0.0	17.2	-	-	0.0	90.0 100.0	-	-	4.4	0.0	17.2	-	-	0.0
		<i>Symbolophorus californiensis</i>															
Station	'97 Dec.	'98 Mar.	May	June	Aug.	Oct.	Nov.	Dec.	Station	'97 Dec.	'98 Mar.	May	June	Aug.	Oct.	Nov.	Dec.
83.3 51.0	-	-	0.0	0.0	4.8	0.0	0.0	0.0	83.3 51.0	-	-	0.0	0.0	4.8	0.0	0.0	0.0
83.3 60.0	-	-	-	0.0	7.4	0.0	0.0	-	83.3 60.0	-	-	-	0.0	7.4	0.0	0.0	-
83.3 80.0	-	-	-	49.6	0.0	0.0	0.0	-	83.3 80.0	-	-	-	49.6	0.0	0.0	0.0	-
83.3 90.0	-	-	-	4.7	4.7	0.0	0.0	-	83.3 90.0	-	-	-	4.7	4.7	0.0	0.0	-
83.3 100.0	-	-	-	8.6	0.0	-	0.0	0.0	83.3 100.0	-	-	-	8.6	0.0	-	0.0	0.0
90.0 53.0	0.0	0.0	-	9.9	0.0	0.0	0.0	0.0	90.0 53.0	0.0	0.0	-	9.9	0.0	0.0	0.0	0.0
90.0 60.0	3.9	9.6	-	0.0	0.0	0.0	-	0.0	90.0 60.0	3.9	9.6	-	0.0	0.0	0.0	-	0.0
90.0 70.0	8.2	13.4	-	4.7	19.4	-	-	0.0	90.0 70.0	8.2	13.4	-	4.7	19.4	-	-	0.0
90.0 80.0	0.0	8.0	0.0	13.9	8.9	0.0	-	4.5	90.0 80.0	0.0	8.0	0.0	13.9	8.9	0.0	-	4.5
90.0 90.0	-	7.2	-	0.0	9.5	-	-	0.0	90.0 90.0	-	7.2	-	0.0	9.5	-	-	0.0
90.0 100.0	-	-	0.0	4.6	0.0	-	-	0.0	90.0 100.0	-	-	0.0	4.6	0.0	-	-	0.0
		<i>Tartarobea crenularis</i>															
Station	'97 Dec.	'98 Mar.	May	June	Aug.	Oct.	Nov.	Dec.	Station	'97 Dec.	'98 Mar.	May	June	Aug.	Oct.	Nov.	Dec.
83.3 55.0	-	-	-	0.0	0.0	0.0	7.8	-	83.3 55.0	-	-	-	0.0	0.0	0.0	7.8	-
83.3 60.0	-	-	-	0.0	0.0	0.0	7.8	-	83.3 60.0	-	-	-	0.0	0.0	0.0	7.8	-
83.3 70.0	-	-	-	0.0	-	0.0	8.2	-	83.3 70.0	-	-	-	0.0	-	0.0	8.2	-
90.0 60.0	0.0	0.0	-	0.0	0.0	0.0	-	10.1	90.0 60.0	0.0	0.0	-	0.0	0.0	0.0	-	10.1
		<i>Trachipterus altivelis</i>															
Station	'97 Dec.	'98 Mar.	May	June	Aug.	Oct.	Nov.	Dec.	Station	'97 Dec.	'98 Mar.	May	June	Aug.	Oct.	Nov.	Dec.
90.0 37.0	0.0	0.0	0.0	0.0	0.0	0.0	0.0	8.8	90.0 37.0	0.0	0.0	0.0	0.0	0.0	0.0	0.0	8.8
90.0 60.0	0.0	4.8	-	0.0	0.0	0.0	-	0.0	90.0 60.0	0.0	4.8	-	0.0	0.0	0.0	-	0.0
		<i>Merluccius productus</i>															
Station	'97 Dec.	'98 Mar.	May	June	Aug.	Oct.	Nov.	Dec.	Station	'97 Dec.	'98 Mar.	May	June	Aug.	Oct.	Nov.	Dec.
83.3 42.0	-	14.8	30.4	0.0	0.0	0.0	0.0	0.0	83.3 42.0	-	14.8	30.4	0.0	0.0	0.0	0.0	0.0
83.3 51.0	-	-	35.5	0.0	0.0	0.0	0.0	0.0	83.3 51.0	-	-	35.5	0.0	0.0	0.0	0.0	0.0
90.0 30.0	0.0	9.6	5.2	0.0	0.0	0.0	0.0	0.0	90.0 30.0	0.0	9.6	5.2	0.0	0.0	0.0	0.0	0.0
90.0 35.0	0.0	75.8	17.8	0.0	0.0	0.0	0.0	0.0	90.0 35.0	0.0	75.8	17.8	0.0	0.0	0.0	0.0	0.0
90.0 37.0	0.0	9.4	9.5	0.0	0.0	0.0	0.0	0.0	90.0 37.0	0.0	9.4	9.5	0.0	0.0	0.0	0.0	0.0

TABLE 8. (cont.)

Station	'97 Dec.	'98 Mar.	May	<i>Merluccius productus</i> (cont.)		Aug.	Oct.	Nov.	Dec.
90.0 45.0	0.0	89.7	14.0	June	0.0	-	0.0	0.0	0.0
90.0 53.0	0.0	5.0	-	June	0.0	0.0	0.0	0.0	0.0
90.0 80.0	0.0	0.0	0.0	4.6	0.0	0.0	0.0	-	0.0
				<i>Chilara taylori</i>					
Station	'97 Dec.	'98 Mar.	May	June	Aug.	Oct.	Nov.	Dec.	
83.3 55.0	-	-	-	11.3	0.0	0.0	0.0	0.0	-
				<i>Ophidion scrippsae</i>					
Station	'97 Dec.	'98 Mar.	May	June	Aug.	Oct.	Nov.	Dec.	
83.3 40.6	-	-	0.0	0.0	2.7	0.0	0.0	0.0	0.0
				<i>Catactyx rubrirostris</i>					
Station	'97 Dec.	'98 Mar.	May	June	Aug.	Oct.	Nov.	Dec.	
83.3 42.0	-	3.0	0.0	0.0	0.0	0.0	0.0	0.0	0.0
90.0 45.0	0.0	0.0	4.7	0.0	-	0.0	0.0	0.0	0.0
				<i>Antennarius avalonis</i>					
Station	'97 Dec.	'98 Mar.	May	June	Aug.	Oct.	Nov.	Dec.	
90.0 100.0	-	-	0.0	0.0	4.3	-	-	-	0.0
				<i>Oneirodes</i> spp.					
Station	'97 Dec.	'98 Mar.	May	June	Aug.	Oct.	Nov.	Dec.	
90.0 100.0	-	-	0.0	0.0	8.6	-	-	-	0.0
				<i>Melamphaes</i> spp.					
Station	'97 Dec.	'98 Mar.	May	June	Aug.	Oct.	Nov.	Dec.	
90.0 60.0	3.9	0.0	-	0.0	8.6	0.0	-	-	0.0
				<i>Melamphaes lugubris</i>					
Station	'97 Dec.	'98 Mar.	May	June	Aug.	Oct.	Nov.	Dec.	
83.3 70.0	-	-	-	4.6	-	0.0	0.0	0.0	-
83.3 80.0	-	-	-	4.1	0.0	0.0	0.0	0.0	-
90.0 35.0	0.0	0.0	4.5	0.0	0.0	0.0	0.0	0.0	0.0
90.0 37.0	0.0	0.0	0.0	0.0	0.0	4.7	0.0	0.0	0.0
90.0 60.0	0.0	0.0	-	5.0	4.7	0.0	-	-	0.0
90.0 80.0	0.0	0.0	0.0	0.0	8.9	0.0	-	-	0.0
90.0 100.0	-	-	0.0	0.0	4.3	-	-	-	0.0
				<i>Melamphaes parvus</i>					
Station	'97 Dec.	'98 Mar.	May	June	Aug.	Oct.	Nov.	Dec.	
90.0 70.0	0.0	4.5	-	0.0	0.0	-	-	-	0.0

TABLE 8. (cont.)

Station	'97 Dec.	'98 Mar.	May	June	Aug.	Oct.	Nov.	Dec.
<i>Poromitra crassiceps</i>								
83.3 100.0	-	-	-	4.3	0.0	-	0.0	0.0
90.0 35.0	0.0	0.0	0.0	4.9	0.0	0.0	0.0	0.0
90.0 80.0	0.0	0.0	0.0	0.0	4.5	0.0	-	0.0
90.0 90.0	-	0.0	-	4.9	0.0	-	-	0.0
<i>Scopelogadus bispinosus</i>								
Station	'97 Dec.	'98 Mar.	May <th>June</th> <th>Aug.</th> <th>Oct.</th> <th>Nov.</th> <th>Dec.</th>	June	Aug.	Oct.	Nov.	Dec.
83.3 80.0	-	-	-	4.1	0.0	0.0	0.0	-
83.3 100.0	-	-	-	0.0	4.8	-	0.0	0.0
90.0 60.0	3.9	0.0	-	5.0	0.0	0.0	-	0.0
90.0 70.0	0.0	0.0	-	9.4	0.0	-	-	0.0
90.0 100.0	-	-	0.0	0.0	4.3	-	-	0.0
<i>Sebastes spp.</i>								
Station	'97 Dec.	'98 Mar.	May <th>June</th> <th>Aug.</th> <th>Oct.</th> <th>Nov.</th> <th>Dec.</th>	June	Aug.	Oct.	Nov.	Dec.
83.3 42.0	-	97.4	20.2	0.0	0.0	0.0	16.8	41.7
83.3 51.0	-	-	0.0	0.0	0.0	7.8	15.2	0.0
83.3 55.0	-	-	-	34.0	0.0	0.0	15.5	-
83.3 60.0	-	-	-	31.5	0.0	4.3	0.0	-
90.0 28.0	0.0	0.0	0.0	0.0	0.0	0.0	4.6	4.3
90.0 30.0	0.0	4.8	0.0	0.0	0.0	0.0	0.0	35.6
90.0 35.0	10.2	49.1	44.6	4.9	0.0	9.4	9.0	8.8
90.0 37.0	0.0	0.0	28.5	9.6	0.0	0.0	0.0	0.0
90.0 45.0	0.0	125.6	0.0	0.0	-	0.0	0.0	0.0
90.0 53.0	25.9	80.2	-	9.9	0.0	0.0	0.0	0.0
90.0 70.0	0.0	4.5	-	0.0	4.9	-	-	0.0
<i>Sebastes aurora</i>								
Station	'97 Dec.	'98 Mar.	May <th>June</th> <th>Aug.</th> <th>Oct.</th> <th>Nov.</th> <th>Dec.</th>	June	Aug.	Oct.	Nov.	Dec.
83.3 42.0	-	0.0	10.1	0.0	0.0	0.0	0.0	0.0
90.0 45.0	0.0	9.0	0.0	0.0	-	0.0	0.0	0.0
<i>Sebastes diploproa</i>								
Station	'97 Dec.	'98 Mar.	May <th>June</th> <th>Aug.</th> <th>Oct.</th> <th>Nov.</th> <th>Dec.</th>	June	Aug.	Oct.	Nov.	Dec.
83.3 42.0	-	0.0	0.0	0.0	0.0	6.1	0.0	0.0
83.3 55.0	-	-	-	11.3	0.0	8.9	0.0	-
90.0 45.0	0.0	9.0	0.0	0.0	-	0.0	0.0	0.0

TABLE 8. (cont.)

Station	'97 Dec.	'98 Mar.	May	June	Aug.	Oct.	Nov.	Dec.
<i>Trachurus symmetricus</i> (cont.)								
90.0 70.0	0.0	0.0	-	14.2	0.0	-	-	0.0
90.0 80.0	0.0	0.0	22.9	0.0	0.0	0.0	-	0.0
90.0 100.0	-	-	4.4	0.0	0.0	-	-	0.0
<i>Brama japonica</i>								
Station	'97 Dec.	'98 Mar.	May	June	Aug.	Oct.	Nov.	Dec.
90.0 80.0	0.0	4.0	0.0	0.0	4.5	0.0	-	0.0
<i>Atractoscion nobilis</i>								
Station	'97 Dec.	'98 Mar.	May	June	Aug.	Oct.	Nov.	Dec.
90.0 35.0	0.0	0.0	0.0	4.9	0.0	0.0	0.0	0.0
<i>Genyonemus lineatus</i>								
Station	'97 Dec.	'98 Mar.	May	June	Aug.	Oct.	Nov.	Dec.
90.0 28.0	0.0	0.0	0.0	0.0	0.0	0.0	0.0	4.3
<i>Seriphus politus</i>								
Station	'97 Dec.	'98 Mar.	May	June	Aug.	Oct.	Nov.	Dec.
83.3 40.6	-	-	0.0	0.0	34.6	0.0	0.0	0.0
90.0 28.0	0.0	0.0	0.0	0.0	0.0	3.3	0.0	0.0
<i>Chromis punctipinnis</i>								
Station	'97 Dec.	'98 Mar.	May	June	Aug.	Oct.	Nov.	Dec.
83.3 40.6	-	-	0.0	0.0	0.0	3.0	0.0	0.0
83.3 42.0	-	0.0	0.0	0.0	103.6	0.0	0.0	0.0
90.0 37.0	0.0	0.0	0.0	0.0	0.0	4.7	0.0	0.0
90.0 60.0	0.0	0.0	-	0.0	0.0	4.7	-	0.0
<i>Oxyjulis californica</i>								
Station	'97 Dec.	'98 Mar.	May	June	Aug.	Oct.	Nov.	Dec.
83.3 42.0	-	0.0	0.0	0.0	14.1	0.0	0.0	0.0
90.0 60.0	0.0	0.0	-	0.0	0.0	9.3	-	0.0
<i>Plectobranchus evides</i>								
Station	'97 Dec.	'98 Mar.	May	June	Aug.	Oct.	Nov.	Dec.
83.3 51.0	-	-	8.9	0.0	0.0	0.0	0.0	0.0
<i>Chiasmodon niger</i>								
Station	'97 Dec.	'98 Mar.	May	June	Aug.	Oct.	Nov.	Dec.
83.3 80.0	-	-	-	20.7	0.0	0.0	0.0	-
83.3 100.0	-	-	-	0.0	9.6	-	0.0	0.0
90.0 53.0	0.0	5.0	-	0.0	0.0	0.0	0.0	0.0
90.0 60.0	3.9	0.0	-	0.0	4.7	0.0	-	0.0

TABLE 8. (cont.)

Station 90.0 70.0						May	June	Aug.	Oct.	Nov.	Dec.
						-	0.0	0.0	-	-	0.0
Station 83.3 40.6						May	June	Aug.	Oct.	Nov.	Dec.
90.0 28.0		'97 Dec.				0.0	0.0	0.0	0.0	0.0	0.0
Station 83.3 40.6						May	June	Aug.	Oct.	Nov.	Dec.
90.0 28.0		'97 Dec.				0.0	0.0	0.0	0.0	0.0	0.0
Station 83.3 42.0						May	June	Aug.	Oct.	Nov.	Dec.
90.0 28.0		'97 Dec.				0.0	5.0	42.6	0.0	0.0	0.0
Station 83.3 60.0						May	June	Aug.	Oct.	Nov.	Dec.
		'97 Dec.				0.0	0.0	4.7	0.0	0.0	0.0
Station 83.3 40.6						May	June	Aug.	Oct.	Nov.	Dec.
83.3 42.0		'97 Dec.				0.0	0.0	4.7	0.0	0.0	0.0
90.0 28.0											
Station 83.3 40.6						May	June	Aug.	Oct.	Nov.	Dec.
90.0 70.0		'97 Dec.				0.0	0.0	16.0	0.0	0.0	0.0
90.0 80.0								179.0	0.0	0.0	0.0
Station 90.0 30.0						May	June	Aug.	Oct.	Nov.	Dec.
		'97 Dec.				0.0	0.0	8.0	0.0	0.0	0.0
								14.1	0.0	0.0	0.0
Station 90.0 90.0						May	June	Aug.	Oct.	Nov.	Dec.
		'97 Dec.				0.0	0.0	0.0	4.7	0.0	0.0

TABLE 8. (cont.)

Station 83.3 42.0	'97 Dec. -	'98 Mar. 0.0	May 0.0	June 0.0	Aug. 18.8	Oct. 0.0	Nov. 0.0	Dec. 0.0
<i>Citharichthys</i> spp.								
Station 83.3 40.6	'97 Dec. -	'98 Mar. -	May 0.0	June 0.0	Aug. 2.7	Oct. 0.0	Nov. 0.0	Dec. 0.0
83.3 42.0	-	0.0	0.0	0.0	4.7	0.0	0.0	0.0
83.3 51.0	-	-	0.0	0.0	9.6	0.0	0.0	0.0
83.3 60.0	-	-	-	0.0	7.4	0.0	0.0	-
83.3 70.0	-	-	-	0.0	-	4.5	0.0	-
90.0 30.0	0.0	4.8	0.0	0.0	0.0	0.0	0.0	0.0
90.0 35.0	0.0	0.0	0.0	0.0	0.0	0.0	0.0	8.8
90.0 37.0	0.0	0.0	0.0	0.0	0.0	0.0	0.0	8.8
<i>Citharichthys stigmaeus</i>								
Station 83.3 51.0	'97 Dec. -	'98 Mar. -	May 0.0	June 0.0	Aug. 4.8	Oct. 0.0	Nov. 0.0	Dec. 0.0
83.3 55.0	-	-	-	0.0	0.0	8.9	0.0	-
83.3 60.0	-	-	-	0.0	0.0	0.0	7.8	-
90.0 28.0	0.0	0.0	4.8	0.0	0.0	3.3	0.0	0.0
90.0 35.0	0.0	0.0	0.0	0.0	7.6	0.0	0.0	0.0
90.0 45.0	0.0	0.0	0.0	0.0	-	0.0	8.8	0.0
90.0 53.0	0.0	0.0	-	0.0	0.0	0.0	9.8	0.0
90.0 80.0	0.0	0.0	0.0	0.0	0.0	4.8	-	0.0
<i>Hippoglossina stomata</i>								
Station 83.3 42.0	'97 Dec. -	'98 Mar. 0.0	May 0.0	June 0.0	Aug. 4.7	Oct. 0.0	Nov. 0.0	Dec. 0.0
<i>Paralichthys californicus</i>								
Station 83.3 40.6	'97 Dec. -	'98 Mar. -	May 0.0	June 0.0	Aug. 2.7	Oct. 0.0	Nov. 0.0	Dec. 0.0
83.3 42.0	-	3.0	0.0	0.0	4.7	0.0	0.0	0.0
90.0 28.0	0.0	3.6	0.0	0.0	5.2	0.0	0.0	0.0
<i>Xystreurus tolepis</i>								
Station 83.3 40.6	'97 Dec. -	'98 Mar. -	May 0.0	June 0.0	Aug. 0.0	Oct. 3.0	Nov. 0.0	Dec. 0.0
<i>Glyptocephalus zachirus</i>								
Station 83.3 60.0	'97 Dec. -	'98 Mar. -	May -	June 10.5	Aug. 0.0	Oct. 0.0	Nov. 0.0	Dec. -

TABLE 8. (cont.)

Station												
83.3	51.0	'97 Dec.	'98 Mar.	May	June	Aug.	Oct.	Nov.	Dec.			
		-	-	35.5	0.0	0.0	0.0	0.0	0.0			
Station												
83.3	40.6	'97 Dec.	'98 Mar.	May	June	Aug.	Oct.	Nov.	Dec.			
90.0	30.0	-	-	0.0	0.0	2.7	0.0	0.0	0.0			
		0.0	0.0	0.0	5.0	0.0	0.0	0.0	0.0			
Station												
90.0	53.0	'97 Dec.	'98 Mar.	May	June	Aug.	Oct.	Nov.	Dec.			
		0.0	5.0	-	0.0	369.3	0.0	0.0	0.0			

Lyopsetta exilis

Pleuronichthys verticalis

Disintegrated fish larvae

PHYLOGENETIC INDEX TO TABLES 4 AND 8

Anguilliformes	
Nemichthyidae	
<i>Nemichthys scolopaceus</i>	46
Saccopharyngiformes	
Cyematidae	
<i>Cyema atrum</i>	46
Clupeiformes	
Clupeidae	
<i>Sardinops sagax</i>	29, 46
Engraulidae	
<i>Engraulis mordax</i>	29, 46
Osmeriformes	
Argentinidae	
<i>Argentina sialis</i>	47
Microstomatidae	
<i>Microstoma</i> spp.	47
<i>Nansenia candida</i>	47
Bathylagidae	
<i>Bathylagus ochotensis</i>	47
<i>Bathylagus pacificus</i>	47
<i>Bathylagus wesethi</i>	47
<i>Leuroglossus stilbius</i>	48
Stomiiformes	
Gonostomatidae	
<i>Cyclothone signata</i>	29, 48
Sternoptychidae	
<i>Argyropelecus affinis</i>	48
<i>Argyropelecus hemigymnus</i>	49
<i>Argyropelecus lychnus</i>	49
<i>Argyropelecus sladeni</i>	49
<i>Danaphos oculatus</i>	49
<i>Sternoptyx</i> spp.	49
Phosichthyidae	
<i>Ichthyococcus irregularis</i>	49
<i>Vinciguerrria lucetia</i>	29, 50
<i>Vinciguerrria poweriae</i>	50
Stomiidae	
Chauliodontinae	
<i>Chauliodus macouni</i>	50
Stomiinae	
<i>Stomias atriventer</i>	50
Melanostomiinae	
<i>Bathophilus flemingi</i>	51
Malacosteidae	
Aristostomias scintillans	51
Idiacanthinae	
<i>Idiacanthus antrostomus</i>	51
Aulopiformes	
Scopelarchidae	
<i>Benthalbella dentata</i>	51
<i>Rosenblattichthys volucris</i>	51
<i>Scopelarchus analis</i>	51
<i>Scopelarchus guentheri</i>	51
Notosudidae	
<i>Scopelosaurus</i> spp.	51
Paralepididae	52
<i>Arctozenus risso</i>	52
<i>Lestidiops ringens</i>	52
Myctophiformes	
Myctophidae	52
Lampanyctinae	
<i>Ceratoscopelus townsendi</i>	30, 52
<i>Diaphus</i> spp.	52
<i>Lampadena urophaos</i>	30, 53
<i>Lampanyctus steinbecki</i>	30, 53
<i>Nannobranchium</i> spp.	30, 53
<i>Nannobranchium hawaiiensis</i>	53
<i>Nannobranchium regale</i>	53
<i>Nannobranchium ritteri</i>	53
<i>Notolychnus valdiviae</i>	54
<i>Notoscopelus resplendens</i>	54
<i>Stenobranchius leucopsarus</i>	54
<i>Triphoturus mexicanus</i>	30, 54
Myctophinae	
<i>Diogenichthys</i> spp.	55
<i>Diogenichthys atlanticus</i>	30, 55
<i>Diogenichthys lanternatus</i>	56
<i>Electrona risso</i>	56
<i>Hygophum atratum</i>	56
<i>Hygophum reinhardtii</i>	56
<i>Myctophum nitidulum</i>	56
<i>Protomyctophum crockeri</i>	56
<i>Symbolophorus californiensis</i>	57
<i>Tarletonbeania crenularis</i>	57
Lampridiformes	
Trachipteridae	
<i>Trachipterus altivelis</i>	57
Gadiformes	
Merlucciidae	
<i>Merluccius productus</i>	30, 57
Ophidiiformes	
Ophidiidae	
<i>Chilara taylori</i>	58
<i>Ophidion scrippsae</i>	58

Bythitidae		<i>Howella</i> spp.	60
<i>Brosmophycis marginata</i>	30	Serranidae	
<i>Cataetyx rubrirostris</i>	58	<i>Paralabrax</i> spp.	33, 60
Lophiiformes		Carangidae	
Antennariidae		<i>Trachurus symmetricus</i>	33, 60
<i>Antennarius avalonis</i>	58	Bramidae	
Oneirodidae		<i>Brama japonica</i>	61
<i>Oneirodes</i> spp.	58	Sciaenidae	
Atheriniformes		<i>Atractoscion nobilis</i>	61
Atherinidae		<i>Genyonemus lineatus</i>	33, 61
<i>Atherinopsis californiensis</i>	30	<i>Seriphus politus</i>	61
<i>Leuresthes tenuis</i>	31	Kyphosidae	
Beloniformes		<i>Girella nigricans</i>	33
Scomberosocidae		<i>Medialuna californiensis</i>	33
<i>Cololabis saira</i>	31	Labroidei	
Exocoetidae		Pomacentridae	
<i>Cheilopogon</i> spp.	31	<i>Chromis punctipinnis</i>	33, 61
<i>Cheilopogon heterurus</i>	31	Labridae	
<i>Cheilopogon pinnatibarbatus</i>	32	<i>Oxyjulis californica</i>	61
<i>Fodiator acutus</i>	32	Zoarcoidei	
Stephanoberyciformes		Stichaeidae	
<i>Melamphaes</i> spp.	58	<i>Plectobranchnus evides</i>	61
<i>Melamphaes lugubris</i>	58	Trachinoidei	
<i>Melamphaes parvus</i>	58	Chiasmodontidae	
<i>Poromitra crassiceps</i>	59	<i>Chiasmodon niger</i>	61
<i>Scopelogadus bispinosus</i>	59	Blennioidei	
Syngnathiformes		Blenniidae	
Centriscidae		<i>Hypsoblennius</i> spp.	33, 62
<i>Macroramphosus gracilis</i>	32	<i>Hypsoblennius gentilis</i>	33
Scorpaeniformes		<i>Hypsoblennius gilberti</i>	34, 62
Sebastidae		<i>Hypsoblennius jenkinsi</i>	34, 62
<i>Sebastes</i> spp.	32, 59	Gobioidei	
<i>Sebastes aurora</i>	59	Gobiidae	
<i>Sebastes diploproa</i>	32, 59	<i>Coryphopterus nicholsii</i>	62
<i>Sebastes jordani</i>	32, 60	Sphyraenoidei	
<i>Sebastes paucispinis</i>	60	Sphyraenidae	
Scorpaenidae		<i>Sphyraena argentea</i>	34, 62
<i>Scorpaena guttata</i>	60	Scombroidei	
Zaniolepididae		Scombridae	
<i>Oxylebius pictus</i>	60	<i>Scomber japonicus</i>	34, 62
<i>Zaniolepis latipinnis</i>	60	Stromateoidei	
Cottidae		Centrolophidae	
<i>Artedius lateralis</i>	60	<i>Icichthys lockingtoni</i>	62
<i>Scorpaenichthys marmoratus</i>	32	Tetragonuridae	
Agonidae		<i>Tetragonurus cuvieri</i>	62
<i>Xeneretmus latifrons</i>	60	Pleuronectiformes	
Perciformes		Paralichthyidae	
Percoidei		<i>Citharichthys</i> spp.	63
Howellidae		<i>Citharichthys sordidus</i>	63

<i>Citharichthys stigmaeus</i>	63
<i>Hippoglossina stomata</i>	63
<i>Paralichthys californica</i>	63
<i>Xystreurus liolepis</i>	63
Pleuronectidae	

<i>Glyptocephalus zachirus</i>	63
<i>Lyopsetta exilis</i>	64
<i>Pleuronichthys coenosus</i>	34
<i>Pleuronichthys verticalis</i>	64
Disintegrated fish larvae	64

ALPHABETICAL INDEX INDEX TO TABLES 4 AND 8

<i>Antennarius avalonis</i>	58	<i>Howella</i> spp.	60
<i>Arctozenus risso</i>	52	<i>Hygophum atratum</i>	56
<i>Argentina sialis</i>	47	<i>Hygophum reinhardtii</i>	56
<i>Argyropelecus affinis</i>	48	<i>Hypsoblennius gentilis</i>	33
<i>Argyropelecus hemigymnus</i>	49	<i>Hypsoblennius gilberti</i>	34, 62
<i>Argyropelecus lychnus</i>	49	<i>Hypsoblennius jenkinsi</i>	34, 62
<i>Argyropelecus sladeni</i>	49	<i>Hypsoblennius</i> spp.	33, 62
<i>Aristostomias scintillans</i>	51	<i>Ichthyococcus irregularis</i>	49
<i>Artedius lateralis</i>	60	<i>Icichthys lockingtoni</i>	62
<i>Atherinopsis californiensis</i>	30	<i>Idiacanthus antrostomus</i>	51
<i>Atractoscion nobilis</i>	61	<i>Lampadena urophaos</i>	30, 53
<i>Bathophilus flemingi</i>	51	<i>Lampanyctus steinbecki</i>	30, 53
<i>Bathylagus ochotensis</i>	47	<i>Lestidiops ringens</i>	52
<i>Bathylagus pacificus</i>	47	<i>Leuresthes tenuis</i>	31
<i>Bathylagus wesethi</i>	47	<i>Leuroglossus stilbius</i>	48
<i>Benthalbella dentata</i>	51	<i>Lyopsetta exilis</i>	64
<i>Brama japonica</i>	61	<i>Macroramphosus gracilis</i>	32
<i>Brosomphycis marginata</i>	30	<i>Medialuna californiensis</i>	33
<i>Cataetyx rubrirostris</i>	58	<i>Melamphaes lugubris</i>	58
<i>Ceratospelus townsendi</i>	30, 52	<i>Melamphaes parvus</i>	58
<i>Chauliodus macouni</i>	50	<i>Melamphaes</i> spp.	58
<i>Cheilopogon heterurus</i>	31	<i>Merluccius productus</i>	30, 57
<i>Cheilopogon pinnatibarbus</i>	32	<i>Microstoma</i> spp.	47
<i>Cheilopogon</i> spp.	31	Myctophidae	52
<i>Chiasmodon niger</i>	61	<i>Myctophum nitidulum</i>	56
<i>Chilara taylori</i>	58	<i>Nannobranchium hawaiiensis</i>	53
<i>Chromis punctipinnis</i>	33, 61	<i>Nannobranchium regale</i>	53
<i>Citharichthys sordidus</i>	63	<i>Nannobranchium ritteri</i>	53
<i>Citharichthys</i> spp.	63	<i>Nannobranchium</i> spp.	30, 53
<i>Citharichthys stigmaeus</i>	63	<i>Nansenia candida</i>	47
<i>Cololabis saira</i>	31	<i>Nemichthys scolopaceus</i>	46
<i>Coryphopterus nicholsii</i>	62	<i>Notolychnus valdiviae</i>	54
<i>Cyclothone signata</i>	29, 48	<i>Notoscopelus resplendens</i>	54
<i>Cyema atrum</i>	46	<i>Oneirodes</i> spp.	58
<i>Danaphos oculatus</i>	49	<i>Ophidion scrippsae</i>	58
<i>Diaphus</i> spp.	52	<i>Oxyjulis californica</i>	61
<i>Diogenichthys atlanticus</i>	30, 55	<i>Oxylebius pictus</i>	60
<i>Diogenichthys lanternatus</i>	56	<i>Paralabrax</i> spp.	33, 60
<i>Diogenichthys</i> spp.	55	Paralepididae	52
Disintegrated fish larvae	64	<i>Paralichthys californiensis</i>	63
<i>Electrona risso</i>	56	<i>Plectobranchnus evides</i>	61
<i>Engraulis mordax</i>	29, 46	<i>Pleuronichthys coenosus</i>	34
<i>Fodiator actus</i>	32	<i>Pleuronichthys verticalis</i>	64
<i>Genyonemus lineatus</i>	33, 61	<i>Poromitra crassiceps</i>	59
<i>Girella nigricans</i>	33	<i>Protomyctophum crockeri</i>	56
<i>Glyptocephalus zachirus</i>	63	<i>Rosenblattichthys volucris</i>	51
<i>Hippoglossina stomata</i>	63	<i>Sardinops sagax</i>	29, 46

<i>Scomber japonicus</i>	34, 62	<i>Stenobranchius leucopsarus</i>	54
<i>Scopelarchus analis</i>	51	<i>Sternoptyx</i> spp.	49
<i>Scopelarchus guentheri</i>	51	<i>Stomias atriventer</i>	50
<i>Scopelogadus bispinosus</i>	59	<i>Symbolophorus californiensis</i>	57
<i>Scopelosaurus</i> spp.	51	<i>Tarletonbeania crenularis</i>	57
<i>Scorpaena guttata</i>	60	<i>Tetragonurus cuvieri</i>	62
<i>Scorpaenichthys marmoratus</i>	32	<i>Trachipterus altivelis</i>	57
<i>Sebastes aurora</i>	59	<i>Trachurus symmetricus</i>	33, 60
<i>Sebastes diploproa</i>	32, 59	<i>Triphoturus mexicanus</i>	30, 54
<i>Sebastes jordani</i>	32, 60	<i>Vinciguerria lucetia</i>	29, 50
<i>Sebastes paucispinis</i>	60	<i>Vinciguerria poweriae</i>	50
<i>Sebastes</i> spp	32, 59	<i>Xeneretmus latifrons</i>	60
<i>Seriphus politus</i>	61	<i>Xenistius californiensis</i>	63
<i>Sphyraena argentea</i>	34,62	<i>Zaniolepis latipinnis</i>	60

RECENT TECHNICAL MEMORANDUMS

Copies of this and other NOAA Technical Memorandums are available from the National Technical Information Service, 5285 Port Royal Road, Springfield, VA 22167. Paper copies vary in price. Microfiche copies cost \$9.00. Recent issues of NOAA Technical Memorandums from the NMFS Southwest Fisheries Science Center are listed below:

- NOAA-TM-NMFS-SWFSC-341 An operational model to evaluate assessment and management procedures for the North Pacific swordfish fishery.
M. LABELLE
(August 2002)
- 342 Ichthyoplankton and station data for surface (Manta) and oblique (Bongo) plankton tows taken during a survey in the eastern tropical Pacific ocean July 28-December 9, 2000.
D.A. AMBROSE, R.L. CHARTER, H.G. MOSER, B.S. MACCALL, and
W. WATSON
(August 2002)
- 343 Monthly mean coastal upwelling indices, west coast of south Africa 1981-2000: Trends and relationships.
J.G. NORTON, F.B. SCHWING, M.H. PICKETT, S.G. CUMMINGS,
D.M. HUSBY, and P.G. JESSEN
(September 2002)
- 344 Comprehensive (1986-2001) characterization of size at sexual maturity for Hawaiian spiny lobster (*Panulirus marginatus*) and slipper lobster (*Scyllarides squammosus*) in the Northwestern Hawaiian Islands.
E.E. DEMARTINI, P. KLEIBER, and G.T. DINARDO
(September 2002)
- 345 Counts of northern elephant seals at rookeries in the Southern California Bight: 1981-2001.
M.S. Lowry
(November 2002)
- 346 U.S. Pacific marine mammal stock assessments: 2002.
J.V. Carretta, M.M. Muto, J. Barlow, J. Baker, K.A. Forney, and M. Lowry
(December 2002)
- 347 Comprehensive evaluation of shallow reef fish populations at French Frigate Shoals, Midway Atoll, Northwestern Hawaiian Islands (1992/93, 1995-2000).
E.E. DeMARTINI, F.A. PARRISH, and R.C. BOLAND
(December 2002)
- 348 Ichthyoplankton and station data for surface (Manta) and oblique (Bongo) plankton tows for California Cooperative Oceanic Fisheries Investigation Survey Cruises in 2001.
D.A. AMBROSE, R.L. CHARTER, and H.G. MOSER
(January 2003)
- 349 Report of ecosystem studies conducted during the 2001 Oregon, California and Washington (ORCAWALE) marine mammal survey on the research vessels *David Starr Jordan* and *McArthur*.
V.A. PHILBRICK, P.C. FIEDLER, L.T. BALLANCE, and D.A. DEMER
(January 2003)
- 350 AMLR 2001/2002 field season report: Objectives, accomplishments, and tentative conclusions.
J.D. LIPSKY, Editor
(March 2003)