

NOAA Technical Memorandum NMFS



OCTOBER 2012

2003 SURVEY OF ROCKFISHES IN THE SOUTHERN CALIFORNIA BIGHT USING THE COLLABORATIVE OPTICAL-ACOUSTIC SURVEY TECHNIQUE

Edited by

David A. Demer

NOAA-TM-NMFS-SWFSC-496

U.S. DEPARTMENT OF COMMERCE
National Oceanic and Atmospheric Administration
National Marine Fisheries Service
Southwest Fisheries Science Center

The National Oceanic and Atmospheric Administration (NOAA), organized in 1970, has evolved into an agency that establishes national policies and manages and conserves our oceanic, coastal, and atmospheric resources. An organizational element within NOAA, the Office of Fisheries is responsible for fisheries policy and the direction of the National Marine Fisheries Service (NMFS).

In addition to its formal publications, the NMFS uses the NOAA Technical Memorandum series to issue informal scientific and technical publications when complete formal review and editorial processing are not appropriate or feasible. Documents within this series, however, reflect sound professional work and may be referenced in the formal scientific and technical literature.



NOAA Technical Memorandum NMFS

This TM series is used for documentation and timely communication of preliminary results, interim reports, or special purpose information. The TMs have not received complete formal review, editorial control, or detailed editing.

OCTOBER 2012

2003 SURVEY OF ROCKFISHES IN THE SOUTHERN CALIFORNIA BIGHT USING THE COLLABORATIVE OPTICAL-ACOUSTIC SURVEY TECHNIQUE

Edited by
David A. Demer

NOAA-TM-NMFS-SWFSC-496

U.S. DEPARTMENT OF COMMERCE

Rebecca Blank, Acting Secretary

National Oceanic and Atmospheric Administration

Jane Lubchenco, Undersecretary for Oceans and Atmosphere

National Marine Fisheries Service

Samuel D. Rauch III, Acting Assistant Administrator for Fisheries

UNITED STATES DEPARTMENT OF COMMERCE
National Oceanic and Atmospheric Administration
NATIONAL MARINE FISHERIES SERVICE
SOUTHWEST FISHERIES SCIENCE CENTER
8901 LA JOLLA SHORES DRIVE
LA JOLLA, CA 92037



2003 Survey of Rockfishes in the Southern California Bight using the Collaborative Optical–Acoustic Survey Technique

COAST03

Report of the data collection, preliminary analysis, and tentative conclusions for the
COAST survey aboard CPFV *Outer Limits*, 4 November 2003 to 4 April 2004

Edited by
David A. Demer

January 2012

U.S. Department of Commerce
National Oceanic and Atmospheric Administration
National Marine Fisheries Service
Southwest Fisheries Science Center
Fisheries Research Division
Advanced Survey Technologies Program
8901 La Jolla Shores Drive
La Jolla, California, U.S.A. 92037

Background	3
Objectives.....	4
Description of operations	4
Summary of results	4
Scientific personnel	5
Cruise reports.....	6
1. Multi-frequency and multi-beam echosounder surveys, submitted by D. A. Demer, D. Needham, K. Baillie, and J. Emery.....	6
1.1 Objectives.....	6
1.2 Accomplishments	6
1.3 Methods.....	6
1.4 Preliminary Results	14
1.5 Tentative Conclusions.....	73
1.6 Problems and Suggestions.....	75
1.7 Disposition of Data.....	75
1.8 Acknowledgements	75
1.9 References	76
2. Optical surveys using a remotely operated vehicle (ROV), submitted K. L. Stierhoff and J. L. Butler	77
2.1 Objectives.....	77
2.2 Accomplishments	77
2.3 Methods.....	77
2.4 Preliminary Results	78
2.5 Tentative Conclusions.....	81
2.6 Problems and Suggestions.....	82
2.7 Disposition of Data.....	82
2.8 Acknowledgements	82

Background

Marine sportfishing in Southern California is a large industry that must be monitored and managed by non-lethal fish surveying techniques if it, and the associated rockfish stocks, are to be maintained. Statewide, thousands of marine sportfishing anglers purchase tickets to board Commercial Passenger Fishing Vessels (CPFV) and also support the tourism businesses in the region. Of the nearly 300 operated CPFVs statewide, approximately two thirds operate from harbors in the Southern California Bight (SCB). Meanwhile, the stocks of lingcod and six rockfish species, including four that are important to California anglers and commercial fishermen (*Sebastes paucispinis*, *S. pinniger*, *S. entomelas* and *S. levis*), are estimated at or below 25% of their pristine levels and have been declared overfished by the Pacific Fisheries Management Council (PFMC). In response, two Marine Conservation Areas (MCAs) were recently created in the SCB. To assess the habitat and stocks of selected rockfish species in these areas, the Fisheries Resources Division of the Southwest Fisheries Science Center has begun developing a non-lethal surveying technique to use in cooperation with the CPFV fleet. The method combines the information from multi-frequency echosounders and a multi-beam sonar deployed from a ship and a high resolution optical imaging system on a remotely operated vehicle deployed from the same or another vessel.

The State and Federal MCAs in southern California cover approximately 5,600 square-n.mi., which provide critical habitat for nearly 60 rockfish species (Love et al 2002). Because numerous species of rockfish coexist in these areas, residing near or on the seabed at depths of approximately 80 to 300 m, and are low in numerical-density, there are many survey challenges. To overcome these obstacles, a combination of survey equipment is required. The challenge is first to identify the essential habitat for these rockfishes, thus reducing the necessary survey area. This can be done with a combination of multi-beam sonar, multi-frequency echosounders, and underwater video. It is also necessary to characterize the frequency dependence of sound scatter from the rockfishes and coexisting species. This can be done by a combination of modeling and measurements of *in-situ* and *ex-situ* fish. Finally, multi-frequency echosounders, and underwater cameras can be used to acoustically survey the rockfishes in their essential habitat and visually confirm the observations, respectively.

While these instruments and their associated data analysis techniques are proven utilities for estimating fish biomass, mapping bathymetry, and visually observing seabed terrain and fish species, many of the techniques must be adapted or redesigned specifically for rockfishes. Despite the challenges, emerging analysis techniques using a combination of data from these instruments are yielding new information on behaviors of rockfishes, their temporal and spatial distributions, and habitat types.

Objectives

The research objective was to develop a new non-invasive, non-lethal method to assess groundfish populations and map their associated seabed habitat in the SCB. More specifically, the effort was to begin developing a survey technique that combines multi-beam sonar measurements for habitat characterization, multi-frequency echosounder measurements for mapping aggregations of rockfishes and facilitating their remote identification, and camera observations from and ROV for validation of the acoustically classified seabed and taxa and estimations of species proportions and their size distributions. Ultimately, it will be necessary to combine these types of data with measures of the biotic and abiotic environment and its effect on the dynamics of rockfish recruitment processes and the dispersion or redistribution of recruits from protected to harvested areas. Such collective knowledge will provide a basis for a longer-term and broader spatial-scale assessment of rockfish and assure the effectiveness of the protected areas in the SCB.

Description of operations

The distributions and abundances of rockfishes were estimated using split-beam echosounders and a multi-beam sonar deployed from a ship, and underwater cameras deployed from a remotely operated vehicle. The multi-beam sonar was used to map the bathymetry, and the echosounder and multi-beam backscatter were used to remotely identify the seabed types. The optical images were used to identify species compositions and estimate their size distributions.

Summary of results

Reported here are the initial studies of rockfishes using the aforementioned combination of instrumentation. This was the SWFSC's first attempt to combine these acoustic and optical measures of rockfishes to estimate their habitat, behaviors, distributions, and abundances. Most of the field efforts focused on characterizing 1) the acoustical spectral signatures for the various species encountered, 2) the site fidelity of the rockfishes, 3) their diel behaviors, and 4) the temporal variability of the mixed species assemblages. A total of 27 grids were occupied during the surveys and a total of 39 ROV transects were made to identify species composition of fish schools.

Scientific personnel

<u>Acoustic samplers</u>	<u>Activity</u>	<u>Institution</u>	<u>Nationality</u>
Kevin Baillie	Masters student	UParis6	France
Dr. David Demer	Research Engineer	SWFSC	USA
Jennifer Emery	Acoustics Technician	SWFSC	USA
Derek Needham	Acoustics Technician	STS	South Africa

<u>Optical samplers</u>	<u>Activity</u>	<u>Institution</u>	<u>Nationality</u>
Thomas Barnes	Fishery Biologist	CDFG	USA
Dr. John Butler	Cruise Leader	SWFSC	USA
Anthony Cossio	Biological Technician	SWFSC	USA
Meisha Key	Fishery Biologist	CDFG	USA
James Kinane	Computer Specialist	SWFSC	USA
Charles Oliver	Computer Specialist	SWFSC	USA
Drew Rapp	ROV Technician	SWFSC	USA
Edward Roberts	Fishery Biologist	CDFG	USA
Sean Suk	NOAA Corps Officer	SWFSC	USA
John Wagner	Biological Technician	SWFSC	USA
Lisa Wertz	Fishery Biologist	CDFG	USA

SWFSC: Southwest Fisheries Science Center

CDFG: California Department of Fish and Game

STS: Sea Technology Services

UParis6: Pierre-and-Marie-Curie University

Cruise reports

1. Multi-frequency and multi-beam echosounder surveys, submitted by D. A. Demer, D. Needham, K. Baillie, and J. Emery

1.1 Objectives

The research objective was to develop acoustic sampling methods for mapping rockfishes, estimating their abundances, and remotely mapping and classifying their seabed habitats in the Southern California Bight (SCB).

1.2 Accomplishments

Initial rockfish studies were conducted from November 2003 through April 2004. A multi-beam echosounder was used to map the rockfish habitat. Data from a multi-frequency echosounder were used to remotely classify seabed. For mapping and classifying seabed and fishes, the frequency- and angular-dependencies of the acoustic backscatter were exploited. Backscatter from different seabed types is dependent on the acoustic wavelength relative to the particulate size, density, and sound speed, and it is a function of the acoustic incidence angle. Volume backscattering strengths at four frequencies were used to remotely identify scatterer taxa (i.e. large fish, small fish, and zooplankton), and to observed their diel behavioral characteristics. The acoustic backscatter from rockfishes was identified using information from an empirical four-frequency acoustical signature and the ROV video. Maps of rockfishes and the seabed were created for navigating the ROV through the fish aggregations.

1.3 Methods

The rockfishes in the selected areas of the Cowcod Conservation Area (CCA) and other areas of the SCB (**Fig. 1.1**) were mapped from CPFV *Outer Limits* using a combination of multi-beam sonar (Simrad SM2000), multiple-frequency echosounders (Simrad EK60), and a remotely operated vehicle equipped with high-resolution video and still cameras. These areas were selected by Captain Ken Franke and Dr. John Butler from the collective records from multiple fishing masters in the commercial fleet.

Throughout the surveys, acoustical volume backscattering strength (S_v ; dB re 1 m) and target strength (TS ; dB 1 m²) values were measured continuously by four echosounders configured with 38, 70, 120, and 200 kHz hull-mounted transducers. During the survey operations, all other echosounders and sonars operating at or near the survey frequencies were secured. This included the ship's Wesmar 160 kHz sonar, and a 38/200 kHz Furuno navigation echosounder.

The transducers, each with nominal 7° beamwidths, were mounted at a depth of approximately 3.7 m. Every second, synchronized pulses of 256 μ s were transmitted downward, received with bandwidths of 3.675, 6.163, 8.710, and 10.635 kHz, respectively, and digitized in quadrature ("raw" data format). These data were averaged every 1 m in range and stored in the "EK500" data format. Data corresponding to ranges of 500 m beneath the transducers were recorded in both formats on computer hard disk

and backed-up to external USB V2.0 hard disk and DVD+R media. Data were processed with Echoview V3.20.87, and distribution maps were created with Surfer V8.00.

The multifrequency echosounders were calibrated three times. The first two calibrations were performed on 4 November 2003, from 1517 to 1748 GMT (0717 to 0948 PST) and from 1752 to 1855 GMT (0952 to 1055 PST) while the ship was anchored at Steeples (32° 56.111N / 117° 18.874'W). The results of these experiments are summarized in **Tables 1.2a and 1.2b**. The third calibration was performed on 5 March 2004 from 1558 to 1815 GMT (0758 to 1015 PST) at Forty-Three Fathom Bank (32° 39.26'N / 117° 58.37'W). The results of this experiment are summarized in **Table 1.3**.

In each of the survey areas (**Fig. 1.1**), a three-dimensional (3-D) seabed was visualized by interpolating the seabed detections from the 38 kHz echosounder to render a surface. Empirical relationships between the S_v at four frequencies (38, 70, 120, and 200 kHz) were used to remotely identify and separate the scatterer taxa (i.e., large fish, small fish, and zooplankton). With additional consideration to the proximity of the fish scatter to the seabed, the rockfish backscatter was thus extracted from the echograms and their 3-D distributions were overlaid on the 3-D rendering of the seabed (e.g., **Fig. 1.2**; view northward unless indicated). Additionally, the integrated volume backscattering coefficients (s_A ; m^2/nm^2) attributed to rockfishes and the area backscattering coefficients (s_a ; m^2/m^2) attributed to three seabed classifications were mapped in plan view (e.g., **Figs. 1.3 and 1.4**, respectively). The acoustically-derived maps of bathymetry and seabed-classifications (e.g., sloped or soft, $0.0 < s_a < 0.07$; hard with relief, $0.071 < s_a < 0.14$; and hard and flat, $0.141 < s_a < 2.0$) were used to direct the ROV for optical spot-validation of seabed types (e.g. sand, mud, cobble/rubble, low relief, low relief with sand, high relief, high relief with sand, and rocky vertical face), using still and video cameras. Preliminary results of the acoustical surveys were used to direct the location and timing of the ROV operations. High resolution underwater video and still-camera images were obtained with the ROV to characterize the fish species and their sizes and validate the acoustical seabed classifications.

Figure 1.1. Survey plan. The Cowcod Conservation Area is pink and outlined in red. The surveyed track line is in green. Bathymetric contour lines are 300, 200, and 100 m.

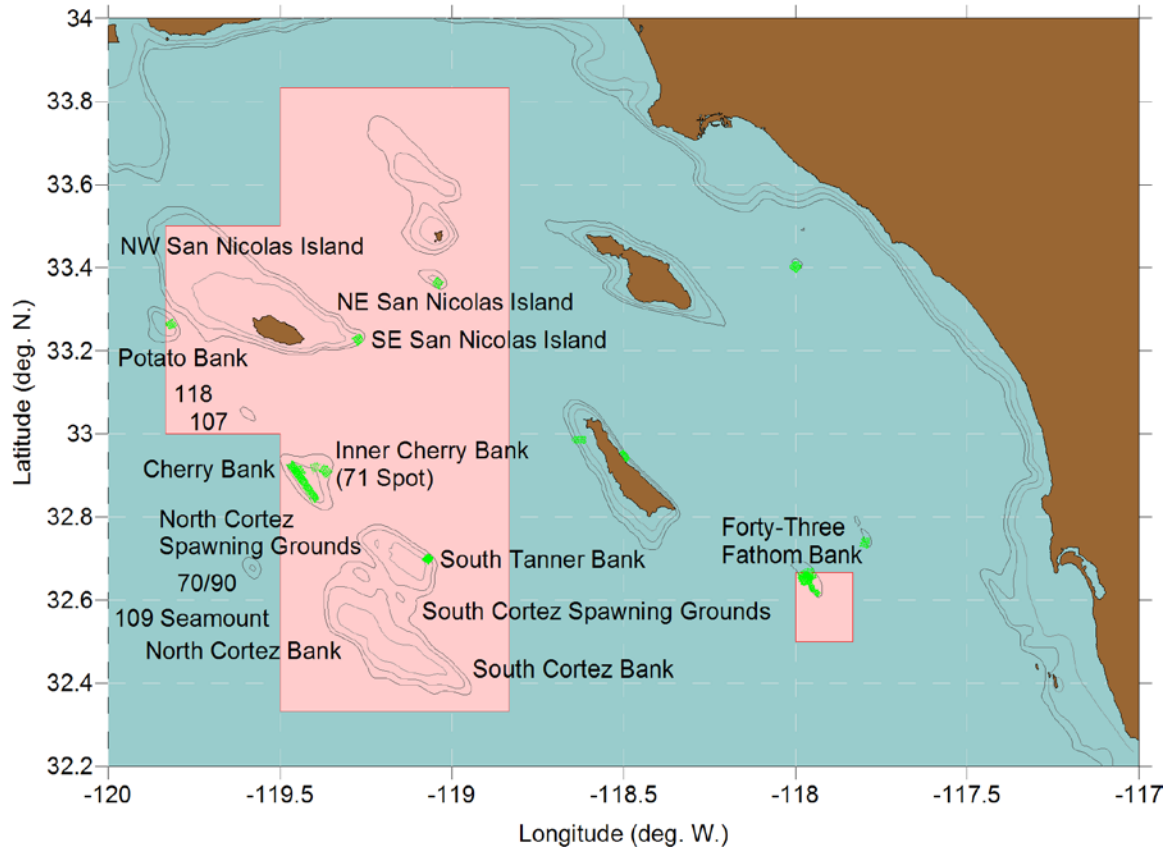

At the conclusion of some surveys, a Seabird Electronics 19plus CTD was deployed in the area to the shallower of 100 m or approximately 5 m above the seabed. For each deployment, the CTD was submerged to a depth of nominally 3 m for 2 min; then, beginning at the surface, the CTD was cast by hand-line to within 5 m of the seabed at apx. 60 m/min, and then retrieved at the same rate. Thus, temperature, salinity, and sound speed profiles were recorded at multiple positions within the SCB.

Next is a description of the survey operations conducted during each of the numbered cruise legs at each of the named survey sites (**Table 1.1**). All times are in GMT unless noted otherwise. Some preliminary results are described (below) and illustrated for the echosounder (**Figs. 1.2-1.82**) and CTD (**Fig. 1.83**) sampling. The *TS* and multi-beam measurements and analysis results will be presented elsewhere.

Table 1.1. Planned survey areas with their approximate transect distances and durations, and their actual beginning and ending dates and times (GMT). The total surveyed track lines totaled 507.4 n.mi. (incomplete surveys are not included).

Survey Order	Survey Leg and Area	Distance (n.mi.)	Time (Days)	Begin Date	Begin Time	End Date	End Time
	Leg 1						
1	Steeple ROV	---	0.04	041103	1754	041103	1855
2	Forty Three Fathom ROV 1	---	0.05	051103	0059	051103	0215
3	Forty Three Fathom Anchored	---	---	051103	0307	061103	0133
4	Forty Three Fathom ROV 2	---	0.07	051103	0437	051103	0618
5	Forty Three Fathom ROV 3	---	0.18	051103	1550	051103	2014
	Leg 2						
1	Cherry Bank		0.06	161103	0017	161103	0152
2	San Clemente Island Grid	17.9	0.14	161103	1830	161103	2147
3	San Clemente Island ROV	---	0.12	161103	2226	171103	0115
4	San Clemente Island CTD	---	---	171103	0220		
5	Forty Three Fathom Grid 1	15.6	0.11	171103	1737	171103	2009
6	Forty Three Fathom ROV 1	---	0.12	171103	2057	171103	2357
7	Forty Three Fathom Grid 2	19.2	0.12	181103	0052	181103	0348
8	Forty Three Fathom CTD 1	---	---	181103	0350		
9	Forty Three Fathom ROV 1	---	0.11	181103	0423	181103	0700
10	Forty Three Fathom Anchored	---	0.32	181103	0722	181103	1457
11	Forty Three Fathom Grid 3	7.6	0.11	181103	1524	181103	1806
12	Forty Three Fathom CTD 2	---	---	181103	1811		
13	Forty Three Fathom ROV 3	---	0.13	181103	1854	181103	2158
	Leg 3						
1	Cherry Bank Grid 1	17.8	0.12	011203	1607	011203	1853
2	Cherry Bank ROV 1	---	0.08	011203	1940	011203	2140
3	Cherry Bank Grid 2	---	0.09	011203	2306	021203	0116
4	Cherry Bank Grid 3 (multi-beam)	78.3	0.49	021203	0438	021203	1630
5	Cherry Bank CTD	---	---	021203	1630		
6	Cherry Bank ROV 2	---	0.08	021203	1816	021203	1933
7	Cherry Bank Grid 4	8.1	0.06	021203	2014	021203	2134
8	Forty Three Fathom Grid 4	42.9	0.36	031203	1921	041203	0359
9	Forty Three Fathom CTD	---	---	041203	0359		
	Leg 4						
1	Cherry Bank Grid 1	13.5	0.11	270104	1517	270104	1753
2	Cherry Bank ROV	---	0.17	270104	2130	270104	2245
3	Cherry Bank Grid 2	20.4	0.10	270104	2344	280104	0215
4	Cherry Bank Grid 3	---	0.03	280104	1330	280104	1418
5	San Clemente Island Grid 1	18.1	0.11	280104	1808	280104	2046
6	San Clemente Island ROV	---	0.09	280104	2214	290104	0022
7	San Clemente Island Grid 4 (multi-beam)	---	0.12	290104	0055	290104	0341
	Leg 5						
1	Forty Three Fathom TS 1	---	0.10	050304	1558	050304	1815
2	Forty Three Fathom ROV 1	---	0.15	050304	2300	060304	0057
3	Forty Three Fathom ROV 2 & multi-beam	---		060304	0110	060304	0232
4	Forty Three Fathom Grid 1 (multi-beam)	---	0.09	060304	0244	060304	0451
5	Forty Three Fathom Anchored	---	0.44	060304	0500	060304	1533

6	Forty Three Fathom TS 2	---	0.21	060304	1711	060304	2209
7	Forty Three Fathom Grid 2	13.2	0.10	060304	2307	070304	0125
8	Forty Three Fathom CTD	---	---	070304	1508		
9	Forty Three Fathom Grid 3	13.0	0.11	070304	1604	070304	1837
10	Forty Three Fathom ROV 3	---	0.05	070304	1932	070304	2043
	Leg 6						
1	Forty Three Fathom Grid	15.9	0.10	120304	1521	120304	1738
2	Forty Three Fathom ROV	---	0.04	120304	1820	120304	1922
3	Forty Three Fathom Anchored	---	0.02	120304	1957	120304	2022
4	Forty Three Fathom CTD	---	---	120304	2022		
5	Forty Three Fathom TS	---	0.09	120304	2101	120304	2307
	Leg 7						
1	Tanner Bank Anchored	---	0.06	130304	1500	130304	1630
2	Tanner Bank TS	---	0.22	130304	1629	130304	2140
3	Tanner Bank Grid 1	13.4	0.09	140304	0112	140304	0319
4	Tanner Bank Grid 2	14.6	0.09	140304	1428	140304	1638
5	Tanner Bank ROV 1	---	0.03	140304	1710	140304	1750
6	Tanner Bank ROV 2	---	0.24	140304	1815	140304	2008
7	Forty-Three Fathom Grid 1	---	0.02	190304	1621	190304	1657
8	Kidney Bank Grid	16.1	0.10	190304	1836	190304	2057
9	Kidney Bank ROV (no ROV data; only logbook entry)	---	0.05	190304	2154	190304	2309
10	Forty Three Fathom Grid 2	15.0	0.10	200304	0110	200304	0332
11	Potato Bank Grid	14.2	0.08	200304	1505	200304	1654
12	Potato Bank ROV	---	0.19	200304	1723	200304	2153
13	North Potato Bank Grid	---	0.02	200304	2303	020304	2334
14	San Nicolas Island Grid	14.0	0.09	210304	1603	210304	1803
15	Osborne Grid	14.1	0.08	210304	2109	210304	2306
16	Osborne ROV	---	0.09	210304	2331	220304	0143
	Leg 8						
1	Forty Three Fathom Grid 1	21.0	0.15	020404	0852	020404	1229
2	Forty Three Fathom Grid 2	19.7	0.15	020404	1240	020404	1616
3	Forty Three Fathom ROV	---	0.07	020404	1630	020404	1810
4	Forty Three Fathom Grid 3	19.6	0.12	020404	1832	020404	2118
5	Lasuen Knoll Grid 1	14.2	0.09	030404	1424	030404	1632
6	Lasuen Knoll ROV 1	---	0.08	030404	1811	030404	2008
7	Lasuen Knoll ROV 2	---	0.04	030404	2008	030404	2106
8	Lasuen Knoll Grid 2	14.8	0.09	030404	2131	030404	2339
9	Lasuen Knoll ROV 3	---		040404	0118	040404	0241
10	San Nicolas Island Grid	15.2	0.10	040404	1448	040404	1708

Cruise Leg 1

Steeple: After performing the first calibration at Steeples (32° 56.111'N / 117° 18.874'W), an ROV survey including video verification of rockfishes began on 04 November at 1754 and ended at 1855. The second calibration began at 1820 and was completed at 1855.

Forty-Three Fathom Bank: The ship proceeded directly to Forty-Three Fathom Bank survey area (32° 38.787'N / 117° 58.391'W). The first ROV survey began on 05 November at 0059 and was completed at 0215 (dive 03-309A; 32 38.7917 N /117 58.3923 W, depth of 105 m). Noise observed on the 200 kHz echosounder appeared to be

associated with ROV operations. An anchored survey (32° 39.243'N / 117° 58.383'W) began on 05 November at 0307 with the ship completing a full revolution around the anchor point with the survey ending on 06 November at 0133. The second ROV survey (dive 03-309B; 32° 39.248'N / 117° 58.335'W; depth of 83 m) began on 05 November at 0437 and was completed at 0618. The third ROV survey began on 05 November at 1550 and was completed at 2014 (dive 03-309C; 32 39.3153 N / 117 58.4009 W; depth of 87 m). A fourth ROV survey began at 2143 and ended on 06 November at 0051 (dive 03-309D; 32° 39.3102'N / 117° 58.3808'W; depth of 86 m). All ROV surveys included video verification of fish species.

Cruise Leg 2

Cherry Bank: The survey began on 16 November 2003 at 0017, continued at a speed of nominally 4 kts and was ended prematurely, at 0152, due to adverse weather conditions. The GPS input to the EK60 was not synchronized for this transect.

San Clemente Island: The ship was re-directed to the leeward (eastside) of San Clemente Island (32° 43.821'N / 119° 13.168'W) where the survey began on 16 November at 1830, continued at a speed of nominally 6 kts, and was completed at 2147. The 200 kHz transducer was set to passive mode for this transect to avoid interference with the multi-beam sonar. The area was surveyed longitudinally (north to south), then latitudinally (east to west), in a grid pattern, to allow the ROV survey to commence as soon as possible following the acoustical observations in the area. The ROV is most effective when assisted by the prevailing current. The ROV survey began on 16 November at 2226 and was completed on 17 November at 0115 (dive 03-320A; 32 57.100 N / 118 30.341 W; depth of 89 m). On 17 November at 0220, a CTD was cast to 91 m.

Forty-Three Fathom Bank: The first grid began on 17 November at 1737, continued at a speed of nominally 6 kts and was completed at 2009. An ROV survey began on 17 Nov at 2057 and was completed at 2357 (dive 03-321A; 32 38.6035 N / 117 58.4376 W; depth 200 m). The second grid began on 18 November at 0052 and was completed at 0348. A CTD was cast in 185 m depth at 0350 (32° 39.180'N / 117° 59.127'W) followed by a second ROV survey which began at 0423 and was completed at 0700 (dive 03-322A; 32 38.6117 N/ 117 58.4579 W; depth of 214 m). *Outer Limits* was anchored at a location with many fish (32° 39.336'N / 117° 58.322'W) for an anchored survey that began at 0722 and was completed at 1457. A third grid began on 18 November at 1524 and was completed at 1806. A second CTD (32° 39.158'N / 117° 59.205'W) was cast at 1811. A third ROV survey began at 1854 and was completed at 2158 (dive 03-322B; 32° 38.6477 N / 117° 58.3093 W; depth of 108 m).

Cruise Leg 3

Cherry Bank: The survey began on 01 December 2003 at 1607 with the 200 kHz transducer in passive mode and was completed at 1853. The ROV survey began at 1940 and was completed at 2140 (dive 03-335A; 32° 54.200'N / 119° 26.865'W; depth of 100 m). The second grid began on 01 December at 2306 and was completed on 02 December

at 0116. The third grid began at 0154, including multi-beam measurements, and continued at a speed of nominally 7 kts. At 0438 it was noted that the logging had stopped. After restarting the data logging, the survey ended at 1630. A CTD was cast on 02 December at 1630. A second ROV transect (dive 03-336A; 32° 50.762'N / 119° 22.957'W, depth of 125 m) began at 1816 and was completed at 1933. A fourth grid began at 2014 and was ended prematurely due to adverse weather conditions at 2134. At 2206, the ship headed to San Clemente Island for shelter.

Forty-Three Fathom Bank: Grid survey began on 03 December at 1921 at a speed of nominally 4.5 kts and was completed on 04 December at 0359. A CTD was cast at 0359.

Cruise Leg 4

Cherry Bank: The first grid survey began on 27 January 2004 at 1517 and was completed at 1753. An ROV survey began at 2130 and was completed at 2245 (dive 04-027B; 32° 54.4269' N/ 119° 26.8872' W; depth of 123 m). The second grid survey began on 27 January at 2344 and was completed on 28 January at 0215. The third grid transect began at 1330 and was ended prematurely at 1418.

San Clemente Island: The first grid survey began on 28 January at 1808 and was completed at 2046. An ROV survey began at 2214 and was completed on 29 January at 0022 (32 59.8168 N / 118 37.5869 W; depth of 96 m). A multi-beam survey began on 29 January 2004 at 0055 and was ended prematurely at 0341.

Cruise Leg 5

Forty-Three Fathom Bank: After calibration on 05 March 2004 from 1558 to 1815, *TS* measurements began at 1813 and ended at 1847. An ROV survey began at 2300 and on 06 March ended at 0057 (32° 39.2428 N / 117° 58.0872 W; depth of 98 m). On 07 March at 0125, a multi-beam survey was conducted simultaneously to characterize seabed type (32° 39.181'N / 117° 58.105'W) with a second ROV survey which began at 0110 and was completed at 0232 (dive 04-066A; 32° 39. 2445' N / 117° 58.1631' W; depth of 94 m). A grid survey with multi-beam sounders began on 06 March at 0244 and was completed at 0451 (no EK60 data were recorded for this survey). An anchored survey began at 0500 and ended at 1533. *TS* measurements began at 1711 and were completed at 2209 with 24 specimens measured, mostly bocaccio (*Sebastes paucispinis*). A second grid survey began at 2307 on 06 March and was completed at 0125 on 07 March. The CTD (32° 39.361'N / 117° 57.834'W) was cast twice on 07 March at 1508, but there were problems with data logging from both casts. The third grid survey began at 1604 and was completed at 1837. A third ROV survey began at 1932 and ended at 2043 (04-067A; 32 38.8430 N / 117 57.1223 W; depth of 200 m).

Cruise Leg 6

Forty-Three Fathom Bank: A grid survey began on 12 March 2004 at 1521 and was completed at 1738. An ROV survey began at 1820 and was completed at 1922 (04-072A;

32 39.1533 N / 117 58.3756 W; depth of 96 m). An anchored survey (32° 39.246'N / 117° 58.443'W) began at 1957 and was completed at 2022. A CTD was cast at 2022. A calibration sphere and weight were lost at 2030. *TS* measurements began at 2101 and were completed at 2307 with 9 specimens measured, mostly ocean whitefish (*Caulolatilus princeps*) and bocaccio (*Sebastes paucispinis*).

Cruise Leg 7

Tanner Bank: An anchored survey (32° 41.407'N / 119° 06.632'W) began on 13 March 2004 at 1500 and was completed on 1630. After anchoring at a second site (32° 42.252'N / 119° 04.079'W), *TS* measurements began at 1629 and were completed at 2140 with 15 specimens measured including 12 vermillion rockfishes (*Sebastes miniatus*) and three bocaccio (*Sebastes paucispinis*). The first grid survey began on 14 March at 0112 and was completed at 0319. The second grid survey began at 1428 and was completed at 1638. The first ROV survey began on 14 March at 1710 and was completed at 1750 (dive 04-074A; 32 42.0174 N / 119 04.2085 W; depth of 118 m) followed by the second ROV survey that was deployed at 1815 and recovered at 2008 (04-074B and C; 32 42.2830 N / 119 04.1838 W; depth of 145 m).

Kidney Bank: A grid survey began on 19 March at 1836 and was completed at 2057. An ROV survey (dive 04-079A; 32° 44.453'N / 117° 48.297'W) began at 2154 and was completed at 2309 (no ROV data recorded).

Forty-Three Fathom Bank: A grid survey initially began on 19 March at 1621 and was ended prematurely at 1657 due to Navy operations. *Outer Limits* returned to the survey site on 20 March at 0110 and was completed at 0332.

Potato Bank: A grid survey began on 20 March at 1505 and was completed at 1654. An ROV survey began at 1723 and was completed at 2153 (dive 04-079A; 33 ° 15.6395'N / 119° 50.0327'W; depth of 99 m).

North Potato Bank: A grid survey began at 2303 and was ended prematurely at 2334 due to a bad Ethernet switch.

San Nicolas Island: A grid survey began on 21 March at 1603 and was completed at 1803.

Osborne Bank: A grid survey began on 21 March at 2109 and was completed at 2306. An ROV survey began at 2331 and was completed on 22 March at 0143 (dive 04-080A; 33° 21.6360N / 119° 03.4071'W; depth of 109).

Cruise Leg 8

Forty-Three Fathom Bank: A grid survey began on 02 April 2004 at 0852 and was completed at 1229 (0052 to 0429 PST). *Outer Limits* repeated the same grid survey from 1240 to 1616 (0440 to 0816 PST) to compare nighttime versus daytime backscatter,

respectively, at the same location. An ROV survey began on 02 April at 1630 and was completed at 1810 (dive 04-092A; 32° 39.5391'N / 117° 58.3174'W, depth of 85 m). A third grid survey began at 1832 and was completed at 2118.

Lasuen Knoll: The first grid survey began on 03 April at 1424 and was completed at 1632 (0624 to 0832 PST). An ROV was deployed at 1811 and was completed at 2008 (dive 04-093A; 33° 23.8840'N / 117° 59.6925'W; depth of 220 m). A second ROV survey began at 2008 and was completed at 2106 (dive 04-093B; 33° 24.4368'N / 118° 00.0475'W; depth of 184). A second grid survey (repeat of the first grid) began at 2131 and was completed at 2339 (1331 to 1539 PST), again, to compare backscatter at the same location at different times (early morning versus early afternoon). A third ROV survey began on 04 April at 0118 and was completed at 0246 (dive 04-093C; 33° 24.6585'N / 117° 58.8501'W; depth of 223 m).

San Nicolas Island: A grid survey began on 04 April 2004 at 1448 and was completed at 1708. There was an ROV dive from 1849 to 2000 (dive 04-094A; 33° 13.3726'N / 119° 16.2596'W; depth of 93 m).

1.4 Preliminary Results

Only the preliminary analysis of acoustic data collected from *Outer Limits* is presented here. For example, it is apparent that most of the acoustic backscatter attributed to rockfishes was measured during daylight hours, within approximately 40 m range from the seabed, and associated with seabed type. The ultimate analysis, which combines these data with those collected with the ROV, will be presented elsewhere.

Cruise Leg 1

Calibration at Steeples: The calibrations were performed in the protected waters at Steeples on 04 November 2003 and at Forty-Three Fathom Bank on 05 March 2004. Calibrations were performed in protected waters greater than 20 m deep at both locations. The results of the first two calibration experiments are summarized in **Tables 1.2a and b**, and the third calibration is summarized in **Table 1.3**, below.

Table 1.2a. Summary of the first EK60 pre-survey calibration (Leg 1), conducted at Steeples on 04 November 2003; 1550-1748 GMT.

Standard	38.1 mm diameter tungsten-carbide sphere
Location	32° 56.111'N / 117° 18.874'W
Water Depth	~89m
Sphere Range	~20 m

	38 kHz	70 kHz*	120 kHz	200 kHz
Noise (dB)	-124	-127	-148	-128
α (dB/km)	9.13	22.50	39.04	55.99
Pulse duration (μs)	512	512	512	512
Transducer Gain (dB)	21.14	27.34	26.31	24.71
s_A corr. (dB)	-0.78	-0.50	-0.62	-0.32

Table 1.2b. Summary of the second EK60 pre-survey calibration (Leg 1), conducted at Steeples on 04 November 2003; 1820-1855 GMT.

Standard	38.1 mm diameter tungsten-carbide sphere
Location	32° 56.111' N / 117° 18.874' W
Water Depth	~91 m
Sphere Range	~20 m

	38 kHz	70 kHz*	120 kHz	200 kHz
Noise (dB)	-126	-130	-147	-129
α (dB/km)	9.13	22.50	39.04	55.99
Pulse duration (μs)	512	512	512	512
Transducer Gain (dB)	21.20	27.07	26.22	24.50
s_A corr. (dB)	-0.78	-0.50	-0.47	-0.02

Table 1.3. Summary of the third EK60 calibration (Cruise Leg 5), conducted at Forty-Three Fathom Bank on 05 March 2004; 1558-1815 GMT.

Standard	38.1 mm diameter tungsten-carbide sphere
Location	32° 39.26' N / 117° 58.37' W
Water Depth	~83 m
Sphere Range	~16 m
Sound speed	1494 m/s

	38 kHz	70 kHz*	120 kHz	200 kHz
Noise (dB)	-127	-128	-146	-129
α (dB/km)	9.78	22.78	37.44	52.68
Pulse duration (μs)	512	512	512	512
Transducer Gain (dB)	20.81	26.89	25.97	24.82
s_A corr. (dB)	-0.78	-0.48	-0.60	-0.31

Cruise Leg 2

San Clemente Island: The densest aggregations of rockfishes (**Figs. 1.2** and **1.3**) were mapped in the central-western and southwest areas and associated with mid and high levels of s_a (**Fig. 1.4**). These are putative high-relief rocky areas. However, the algorithm for disambiguating the effects of seabed slope and seabed type on the s_a index requires refinement and validation from video sampling.

Forty-Three Fathom Bank: This bank is characterized by a plateau having areas of high-relief rock, boulders, cobble, and sand. The densest aggregations of rockfishes were mapped in a rocky area at the center of the bank, extending to the edge of the bank in the southwest (**Fig. 1.5**). Some rockfishes were mapped in the deeper, sandy and cobble regions to the southeast (**Fig. 1.6**). The s_a indicated intermediate to high values on the top of the bank, with highest values associated with the high-relief rocky areas in the center of the plateau (**Fig. 1.7**). Comparing the daytime (0937 to 1209 PST) surveys of rockfishes in this area (**Figs. 1.5** and **1.6**) to the nighttime (1762 to 1948 PST) sampling (**Figs. 1.8** and **1.9**), it is clear that the rockfishes descend to the seabed at night. Comparing two consecutive daytime surveys (**Figs. 1.5** and **1.6** versus **Figs. 1.11** and **1.12**), it appears that the rockfishes have strong site fidelity, at least on this short time-scale (compare **Figs. 1.6** and **1.12**).

Figure 1.2. San Clemente Island (161103) 3-D image of bathymetry (m) and S_v of rockfishes (dB). [View westwards].

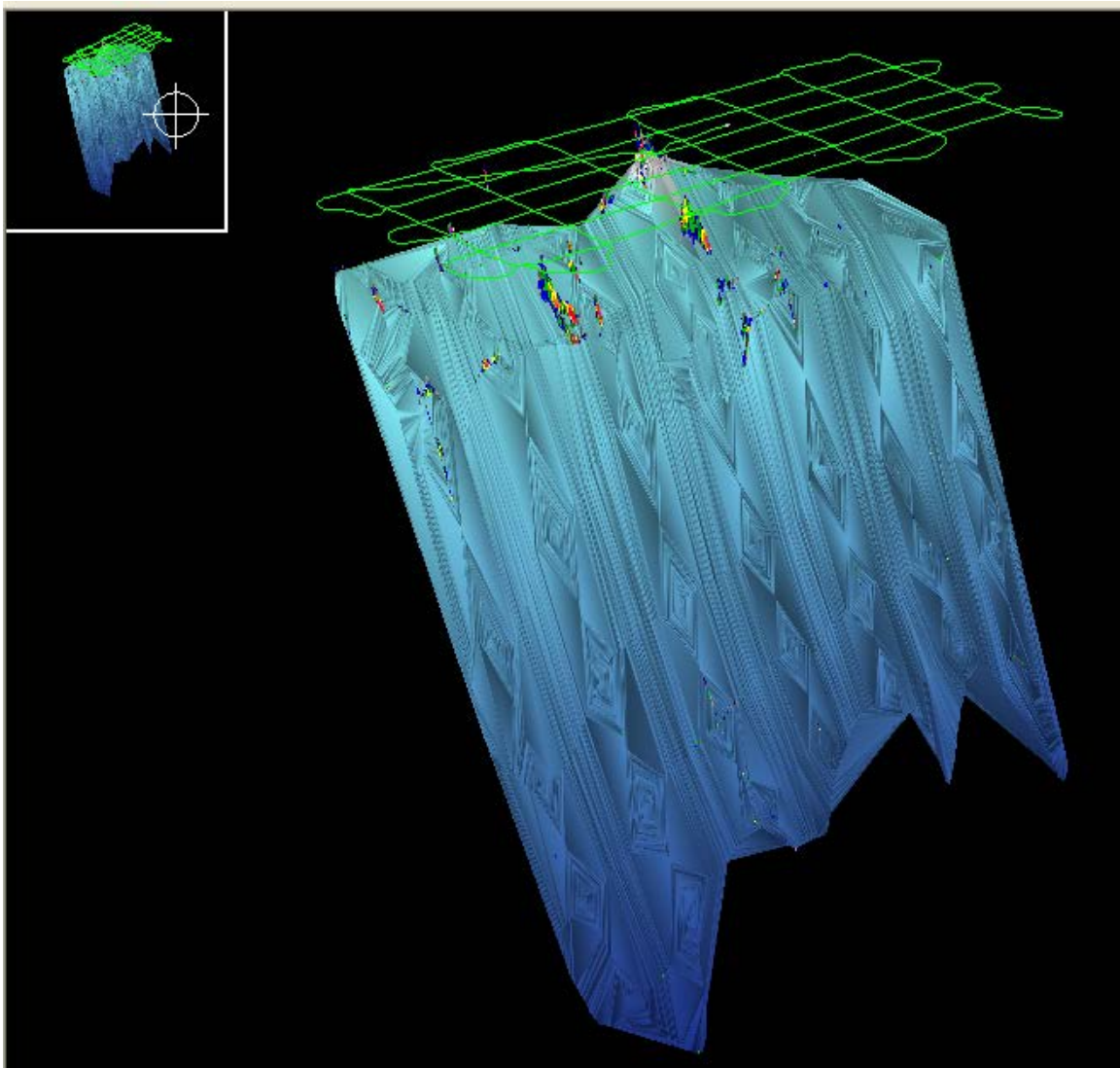

Figure 1.3. San Clemente Island (161103) distribution of s_A ($m^2/n.mi.^2$) attributed to rockfishes.

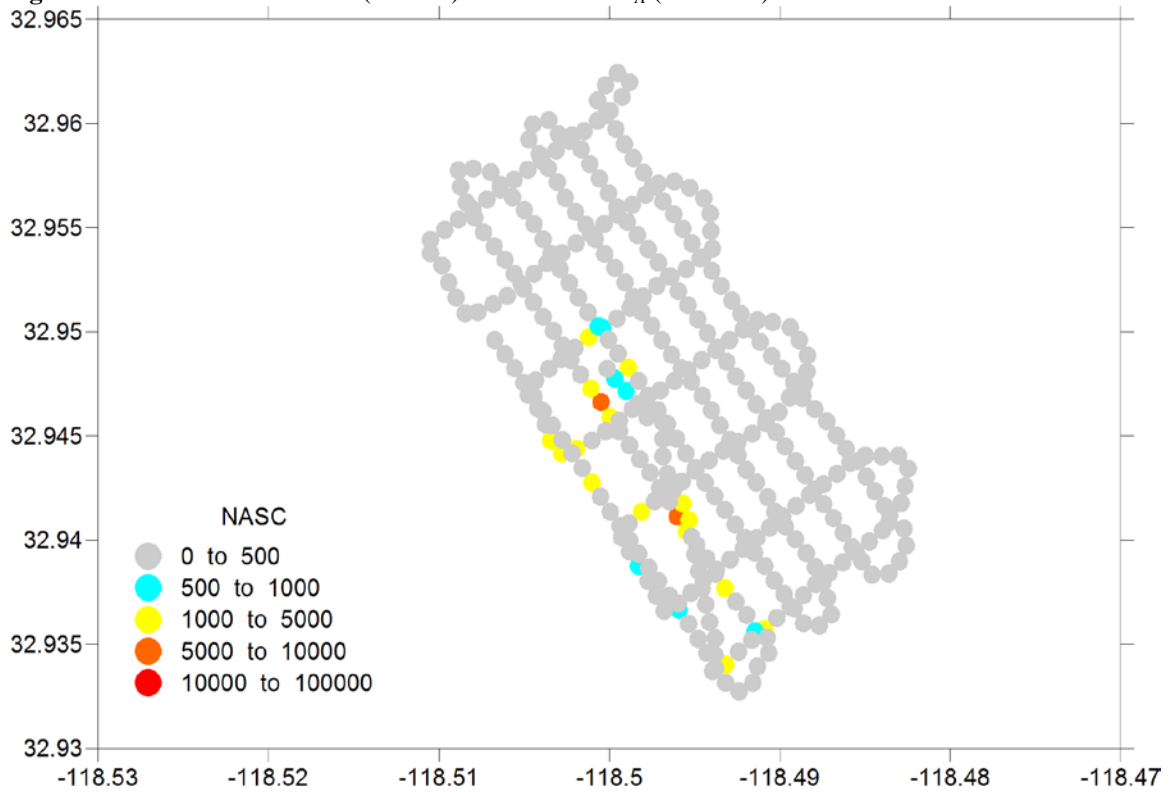

Figure 1.4. San Clemente Island (161103) area backscatter coefficients (s_A ; m^2/m^2) attributed to seabed type.

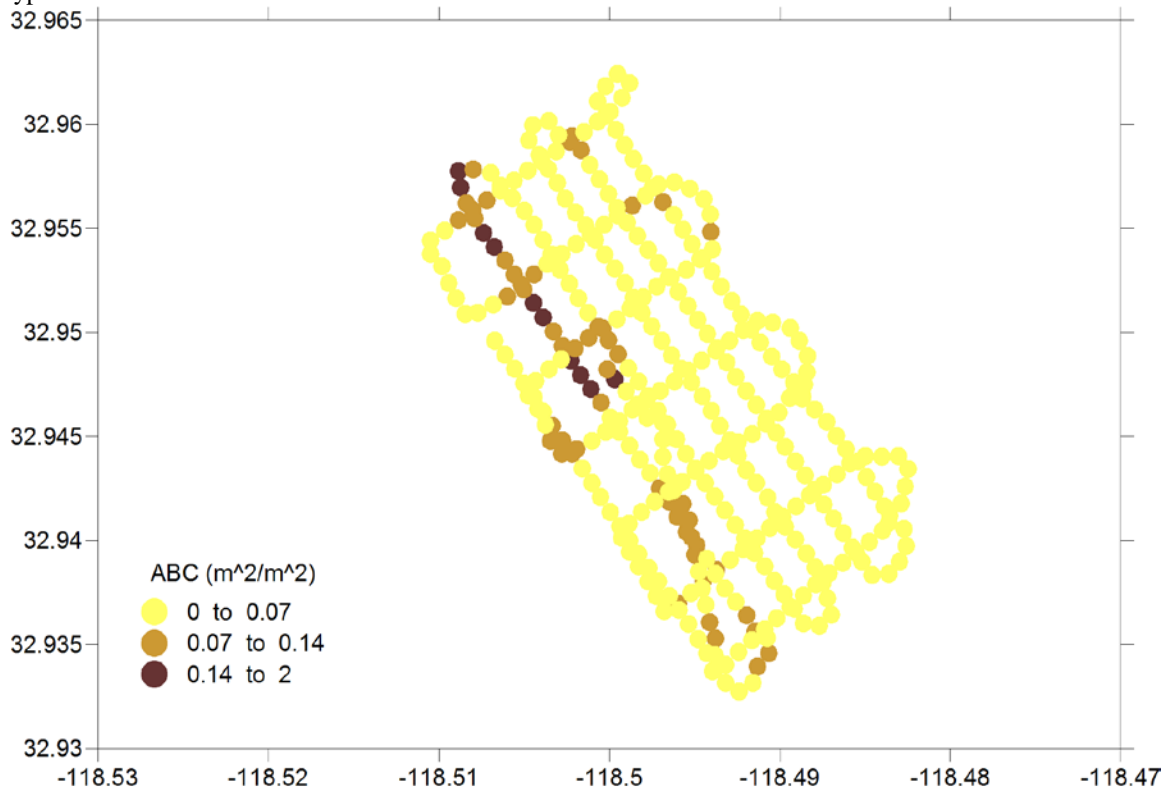

Figure 1.5. Forty-Three Fathom Bank Grid 1 (171103) 3-D image of bathymetry (m) and S_v of rockfishes (dB).

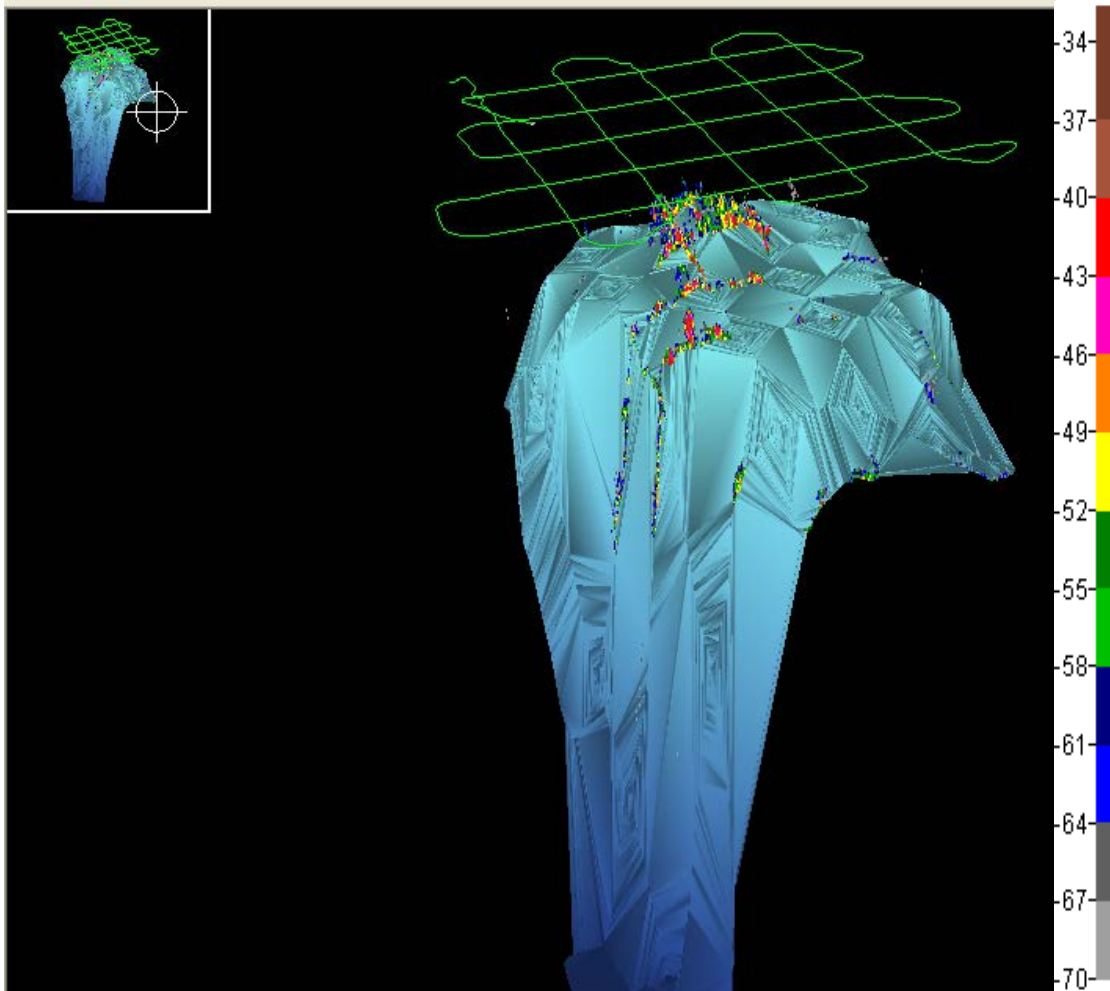

Figure 1.6. Forty-Three Fathom Bank Grid 1 (171103) distribution of s_A ($m^2/n.mi.^2$) attributed to rockfishes.

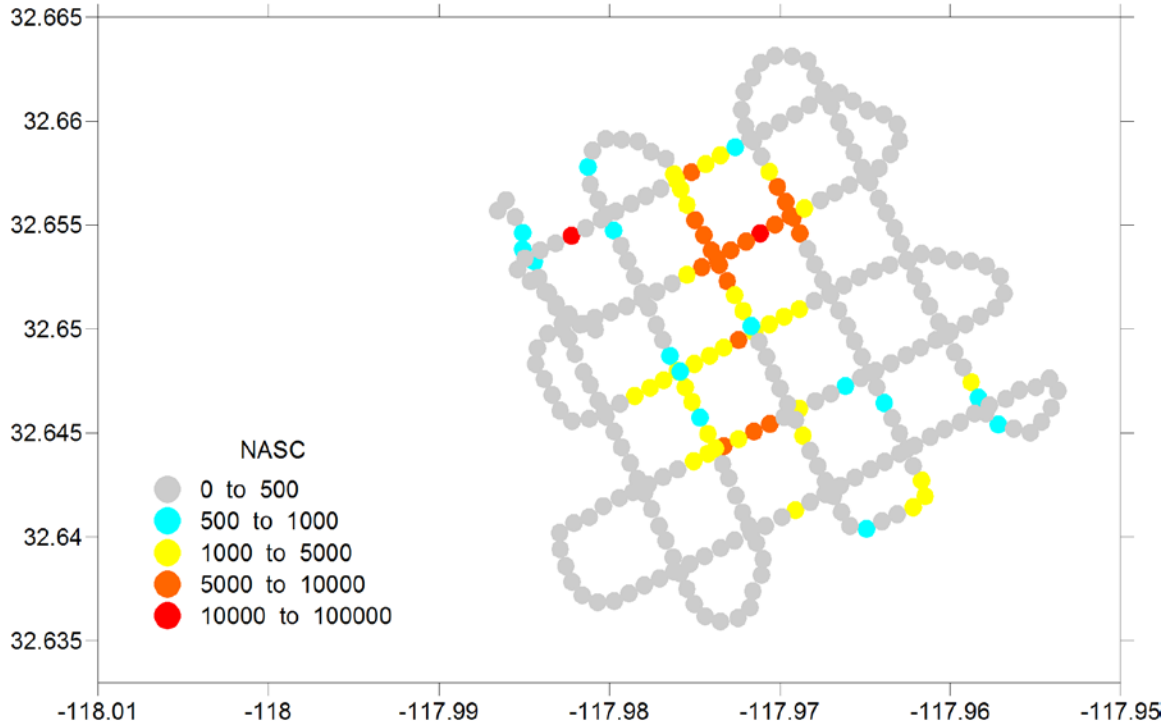

Figure 1.7. Forty-Three Fathom Bank Grid 1 (171103) area backscatter coefficients (s_a ; m^2/m^2) attributed to seabed type.

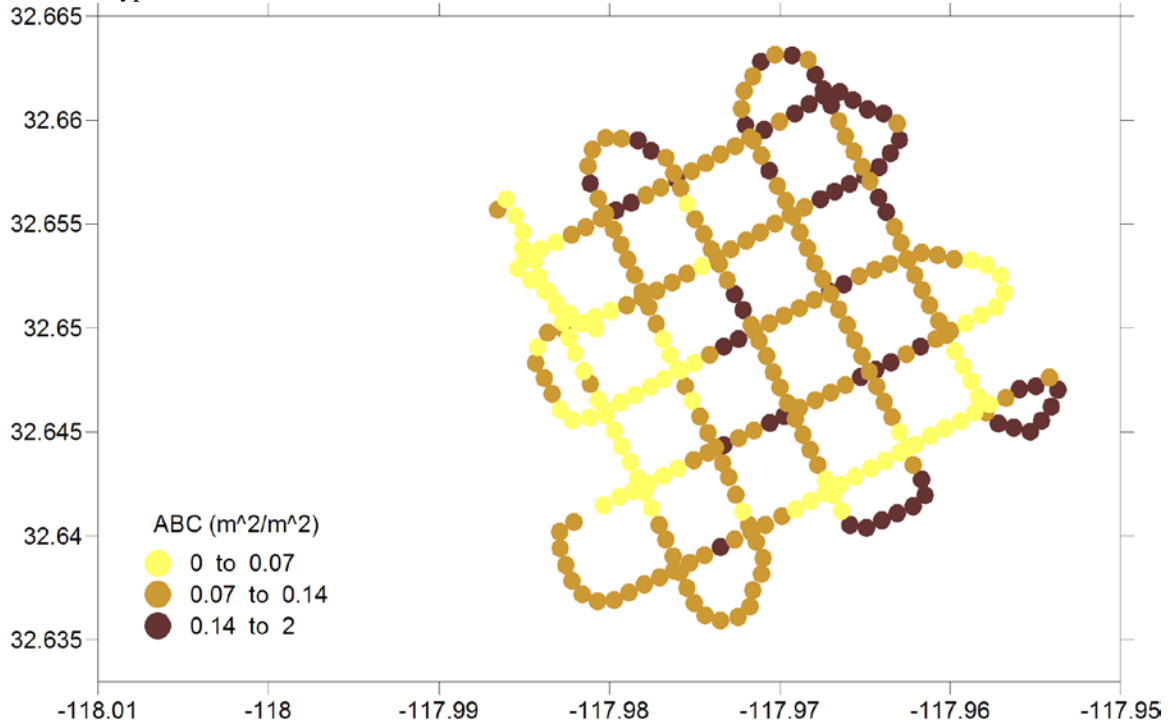

Figure 1.8. Forty-Three Fathom Bank Grid 2 (181103) 3-D image of bathymetry (m) and S_v of rockfishes (dB).

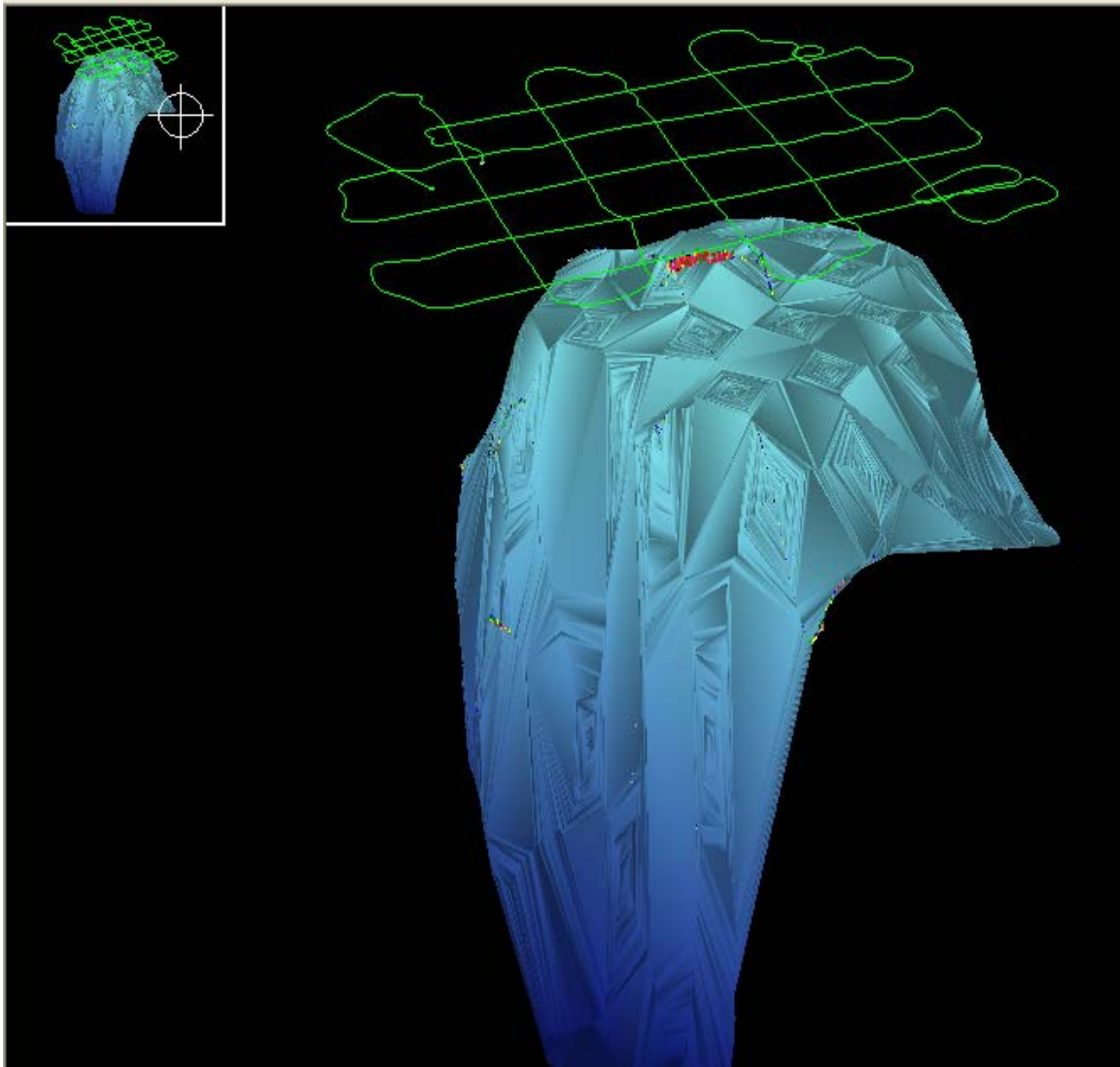

Figure 1.9. Forty-Three Fathom Bank Grid 2 (181103) distribution of s_A ($m^2/n.mi.^2$) attributed to rockfishes.

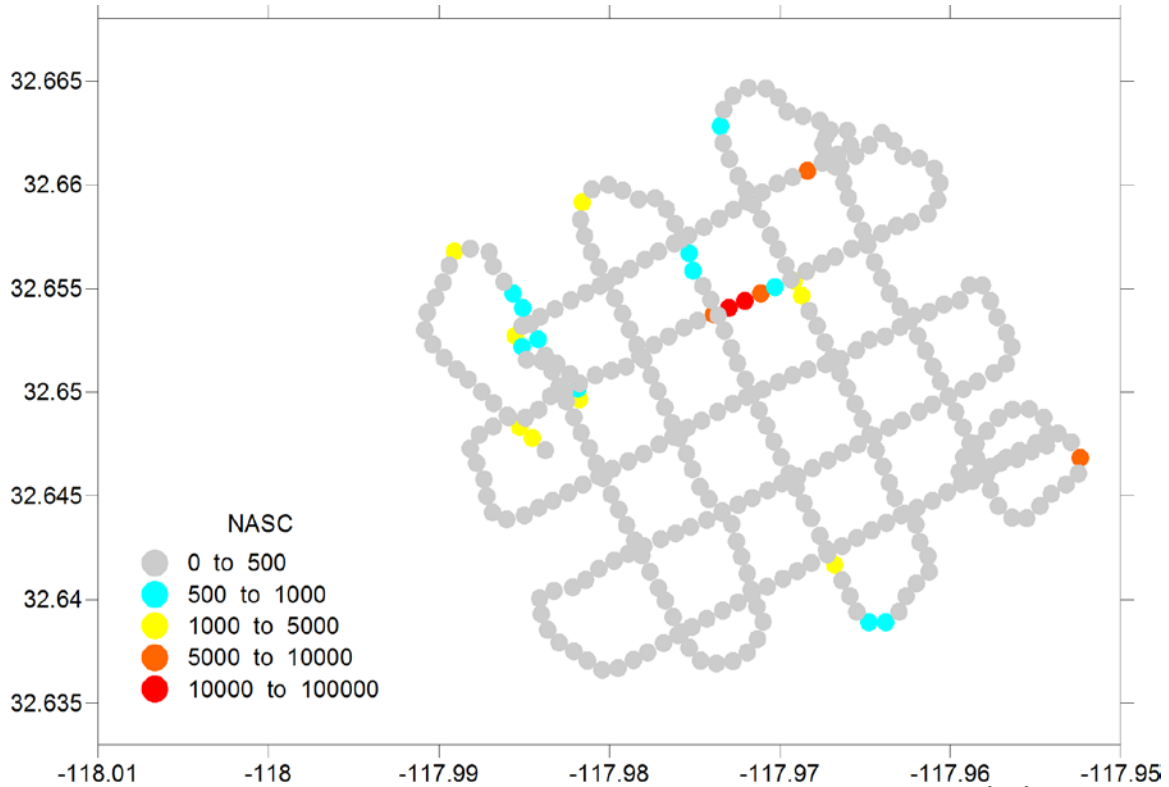

Figure 1.10. Forty-Three Fathom Bank Grid 2 (181103) area backscatter coefficients (s_a ; m^2/m^2) attributed to seabed type.

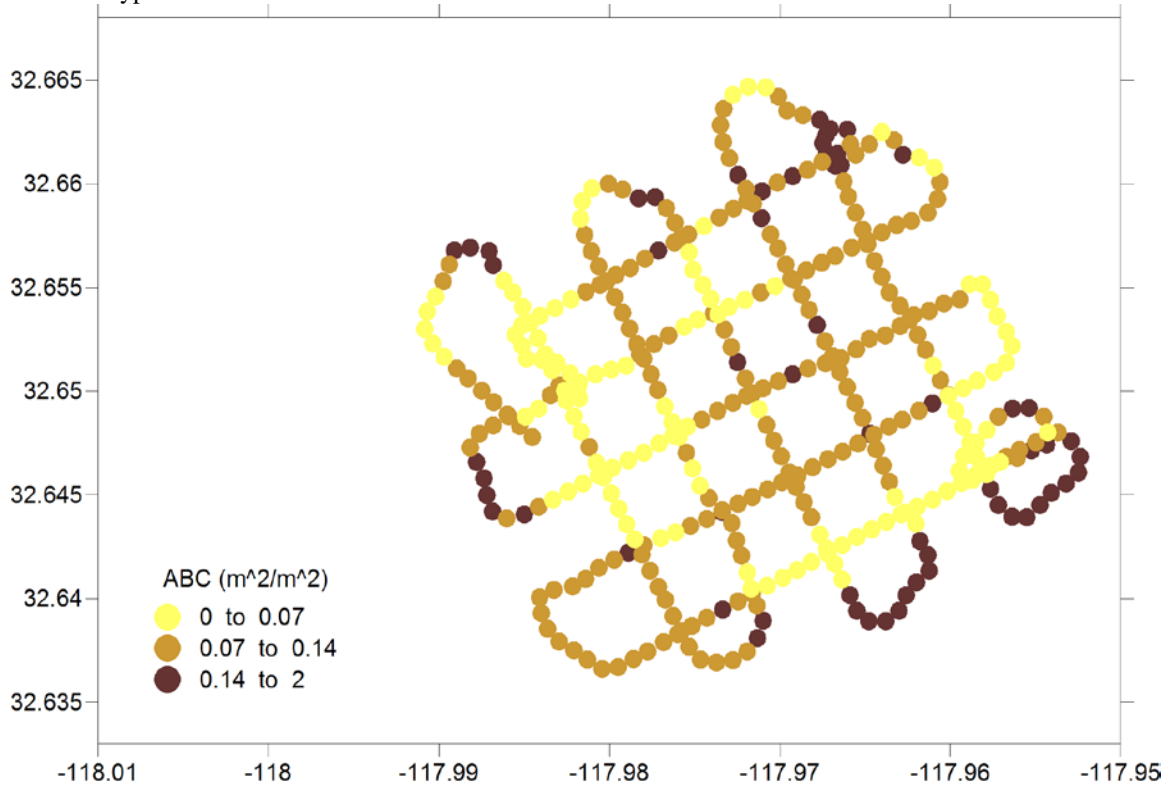

Figure 1.11. Forty-Three Fathom Bank Grid 3 (181103) 3-D image of bathymetry (m) and S_v of rockfishes (dB).

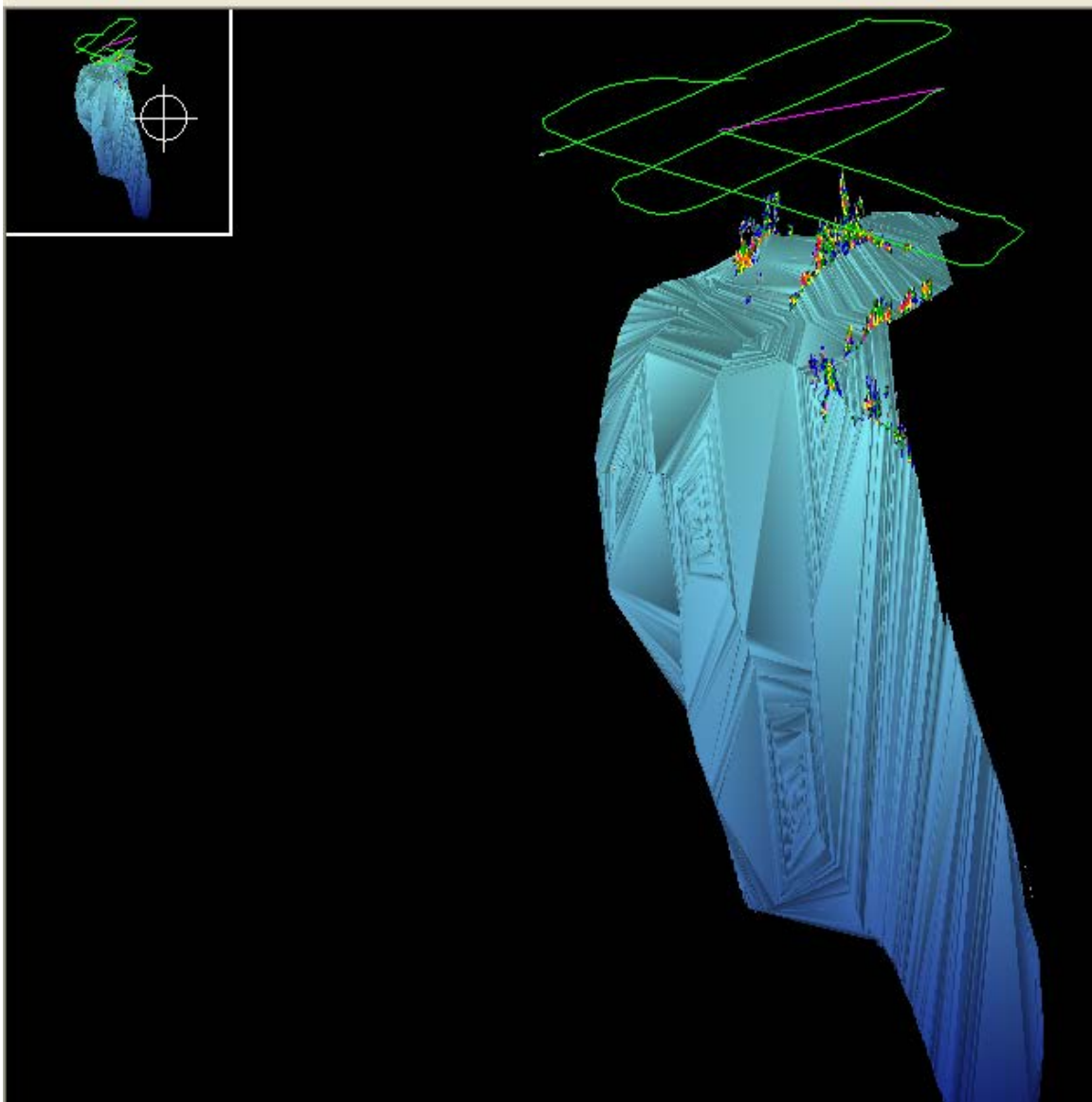

Figure 1.12. Forty-Three Fathom Bank Grid 3 (181103) distribution of s_A ($m^2/n.mi.^2$) attributed to rockfishes.

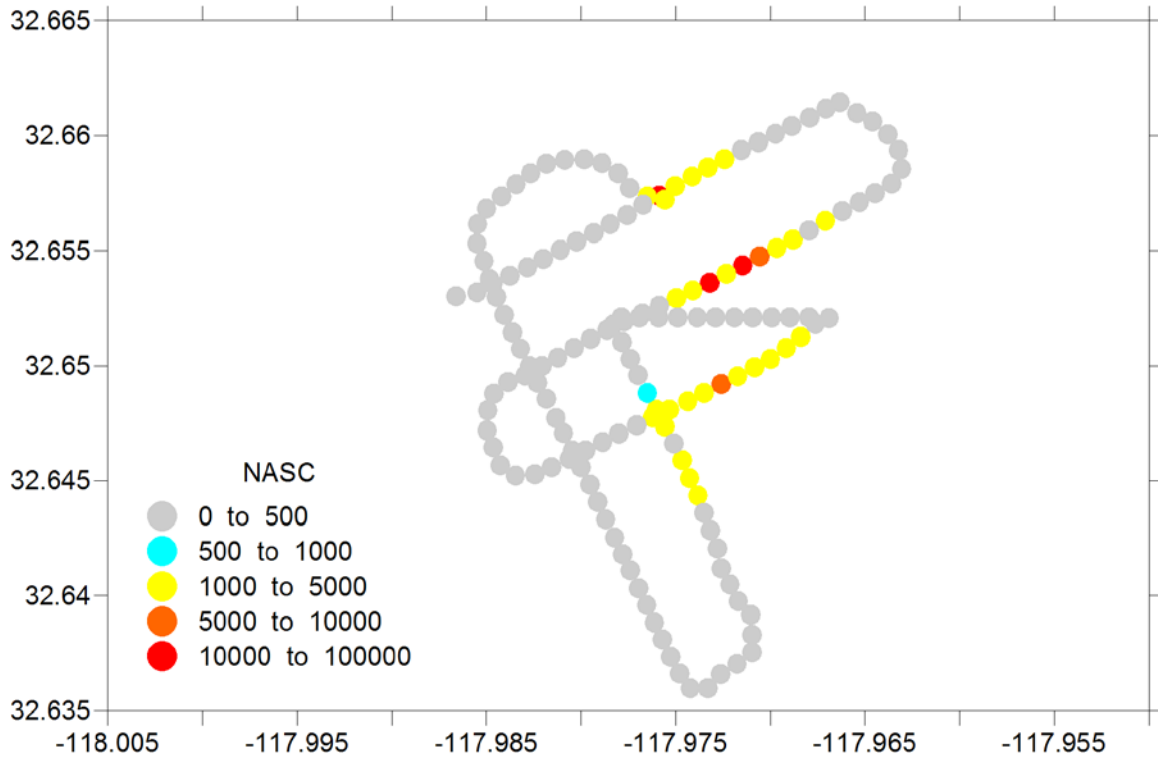
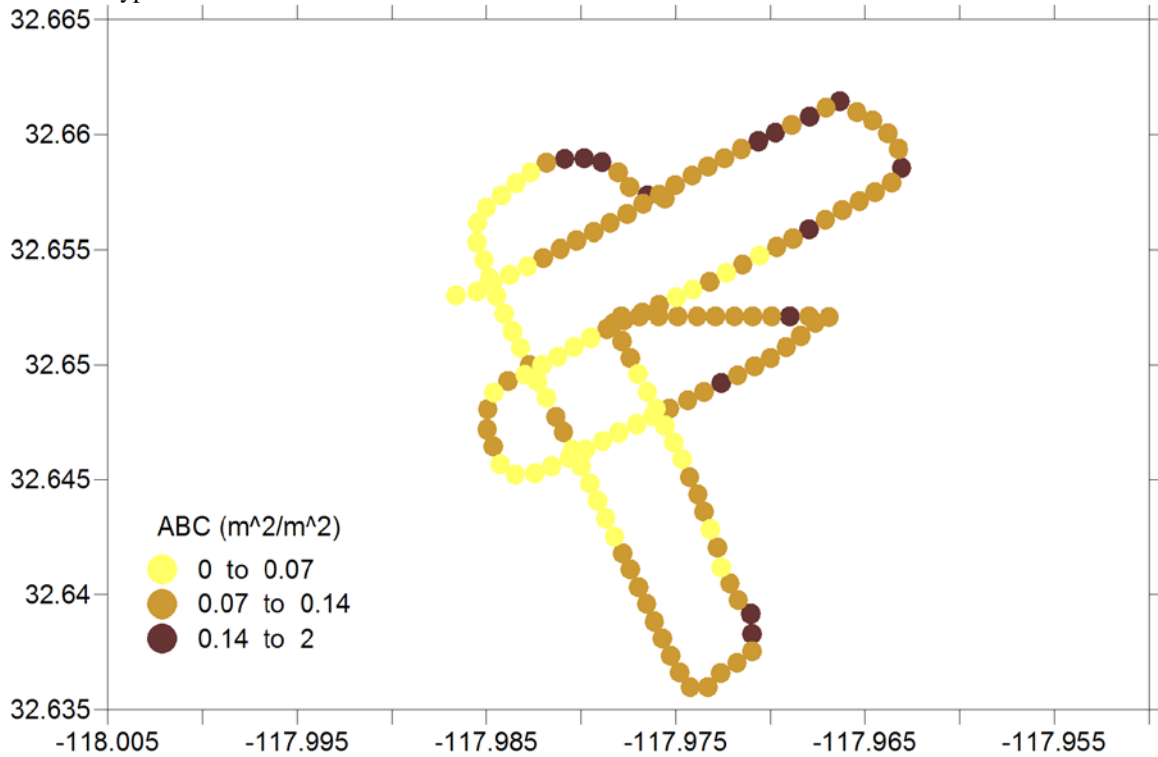

Figure 1.13. Forty-Three Fathom Bank Grid 3 (181103) area backscatter coefficients (s_a ; m^2/m^2) attributed to seabed type.



Cruise Leg 3

Cherry Bank: The higher densities of rockfishes were mapped in the southwestern portion of the grid (**Figs. 1.14** and **1.15**), where the s_a indicated intermediate to high values, generally (**Fig. 1.16**). During the nighttime multi-beam survey (2038 to 0830 PST), few fish were observed with the echosounder (**Figs. 1.17** and **1.18**), again indicating that the rockfishes descend towards the seabed at night. However, during early morning hours, some fish were observed in the putative rocky areas having intermediate-to-high s_a values (**Fig. 1.19**). A second daytime survey of a portion of the bank (**Figs. 20** and **21**) provided additional indication of high site fidelity (compare **Figs. 1.15** and **1.21**).

Forty-Three Fathom Bank: As in previous daytime surveys of this bank, the survey conducted from late morning to mid-evening (1121 to 1959 PST) showed a strong association between dense rockfish aggregations and the rocky seabed on the top of the bank in the southwest. Few rockfishes were associated with the sandy areas, indicated by very high s_a values, in the southeast (**Figs. 1.25**).

Figure 1.14. Cherry Bank Grid 1 (011203) 3-D image of bathymetry (m) and S_v of rockfishes (dB).

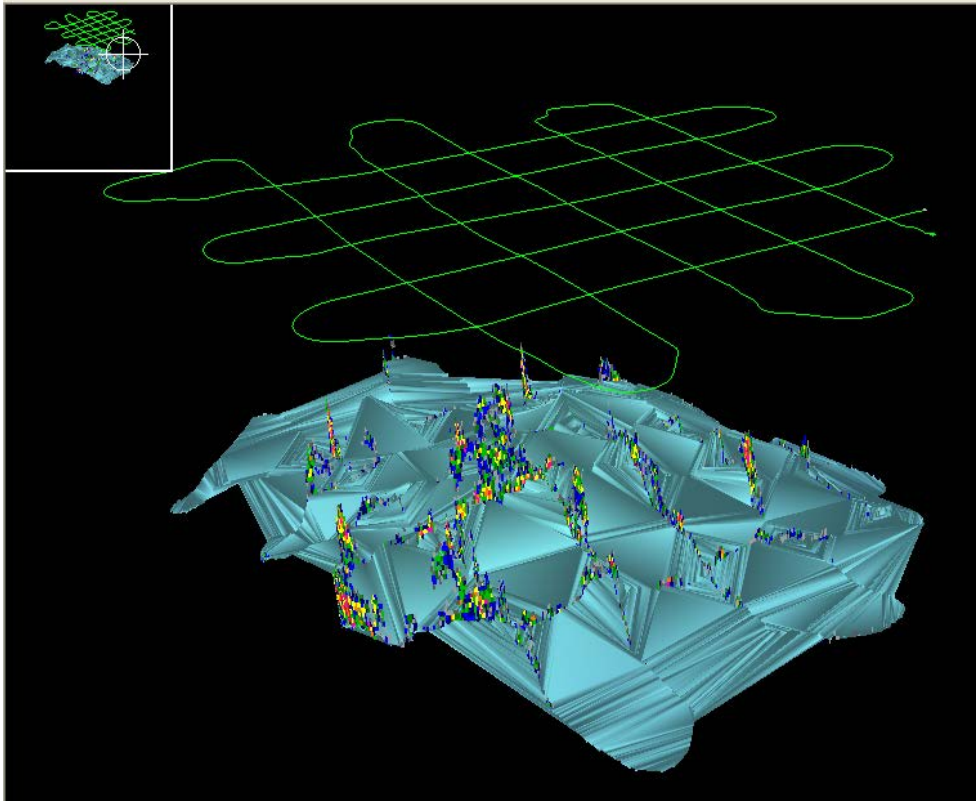

Figure 1.15. Cherry Bank Grid 1 (011203) distribution of s_A ($m^2/n.mi.^2$) attributed to rockfishes.

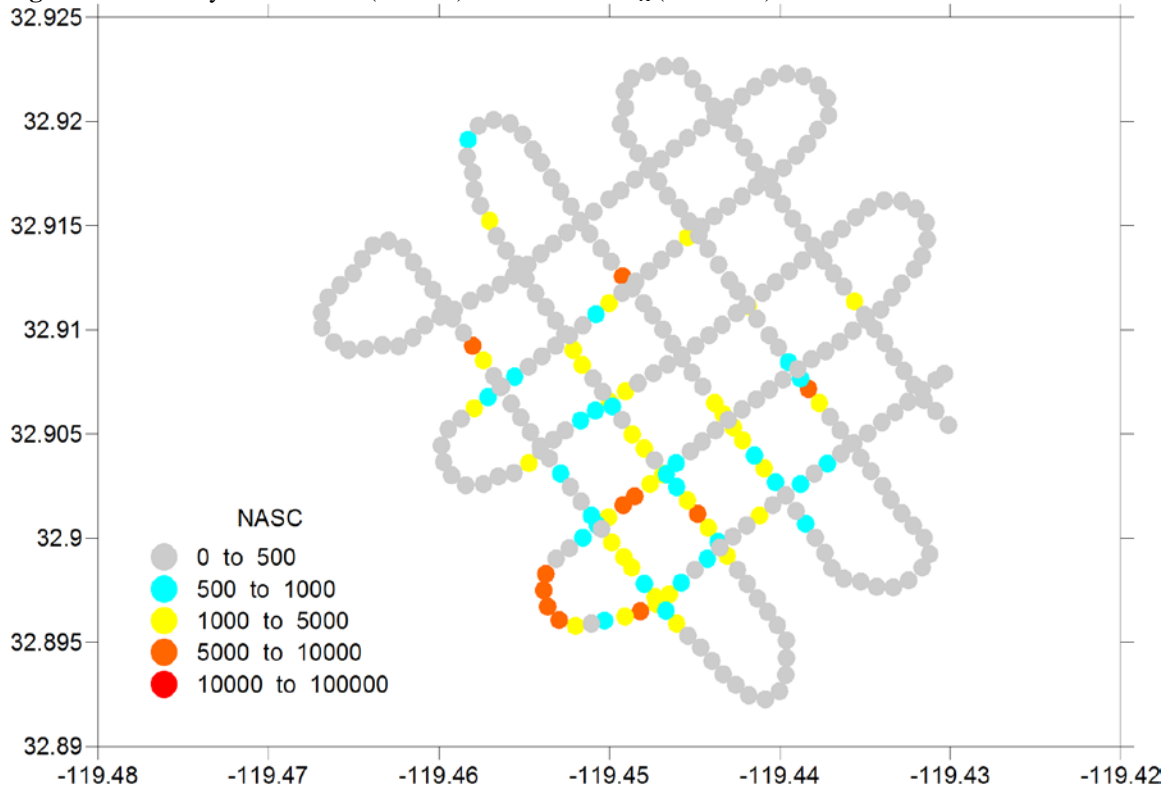

Figure 1.16. Cherry Bank Grid 1 (011203) area backscatter coefficients (s_a ; m^2/m^2) attributed to seabed type.

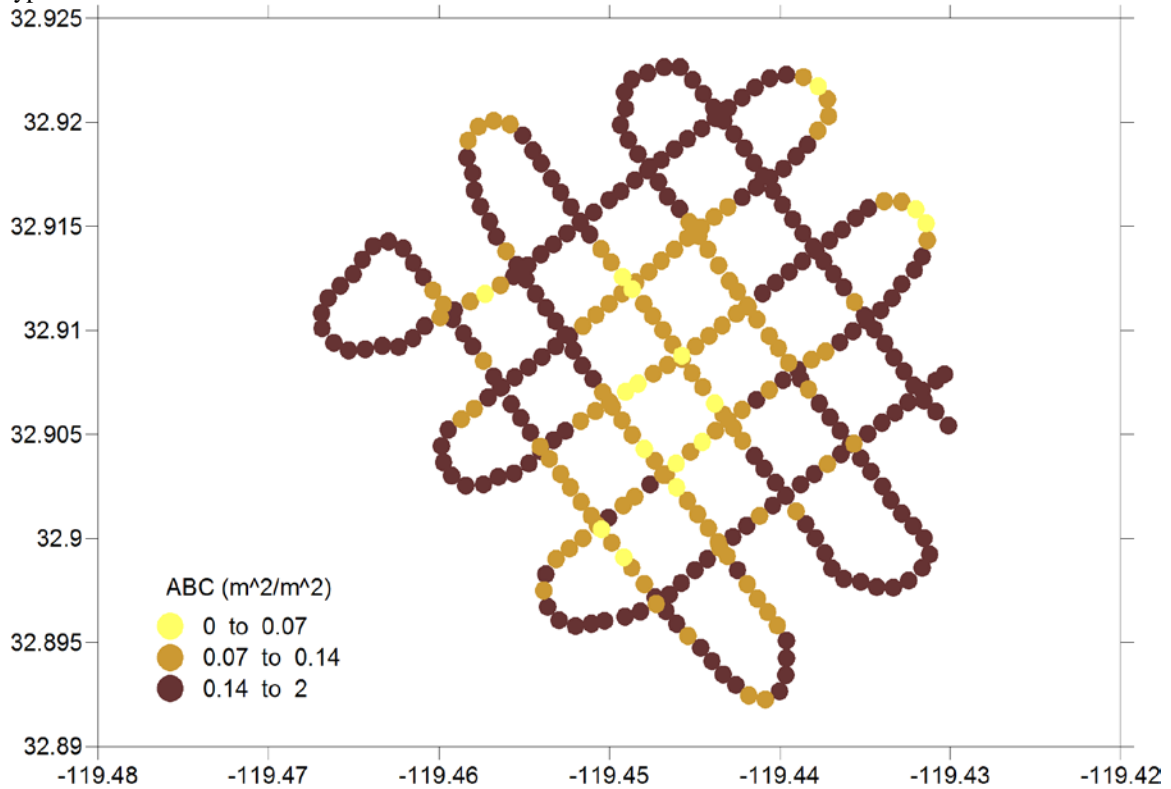

Figure 1.17. Cherry Bank Grid 3 multi-beam (021203) 3-D image of bathymetry (m) and S_v of rockfishes (dB).

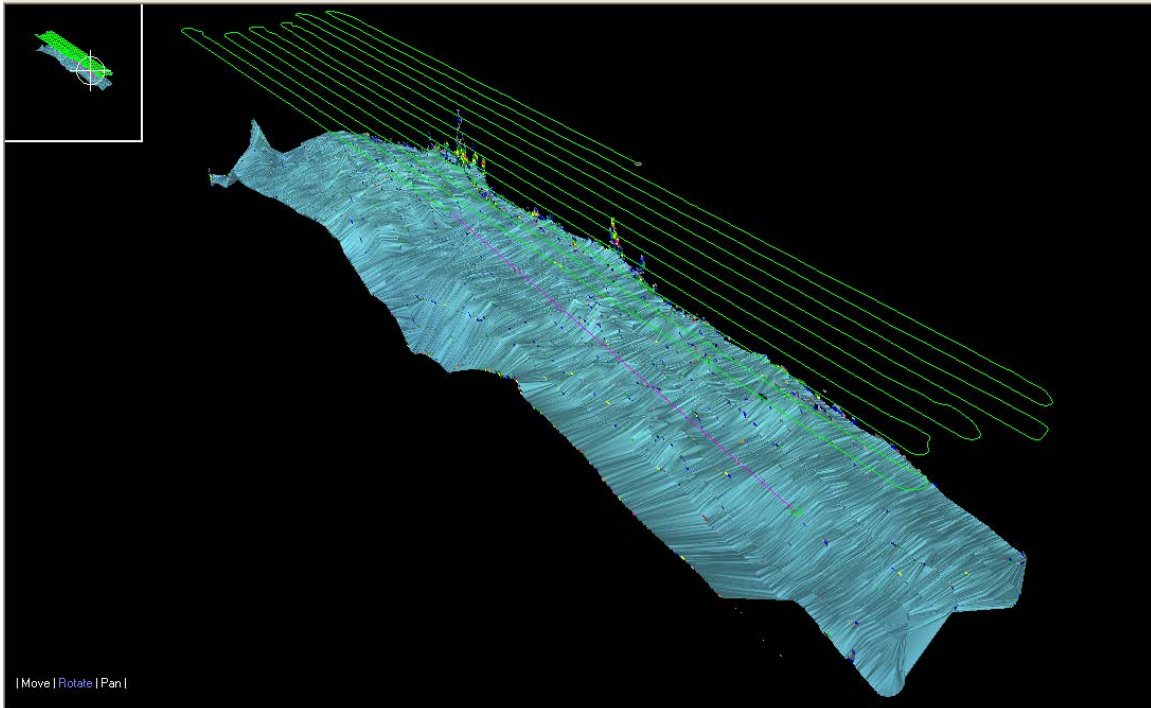

Figure 1.18. Cherry Bank Grid 3 multi-beam (021203) distribution of s_A ($m^2/n.mi.^2$) attributed to rockfishes.

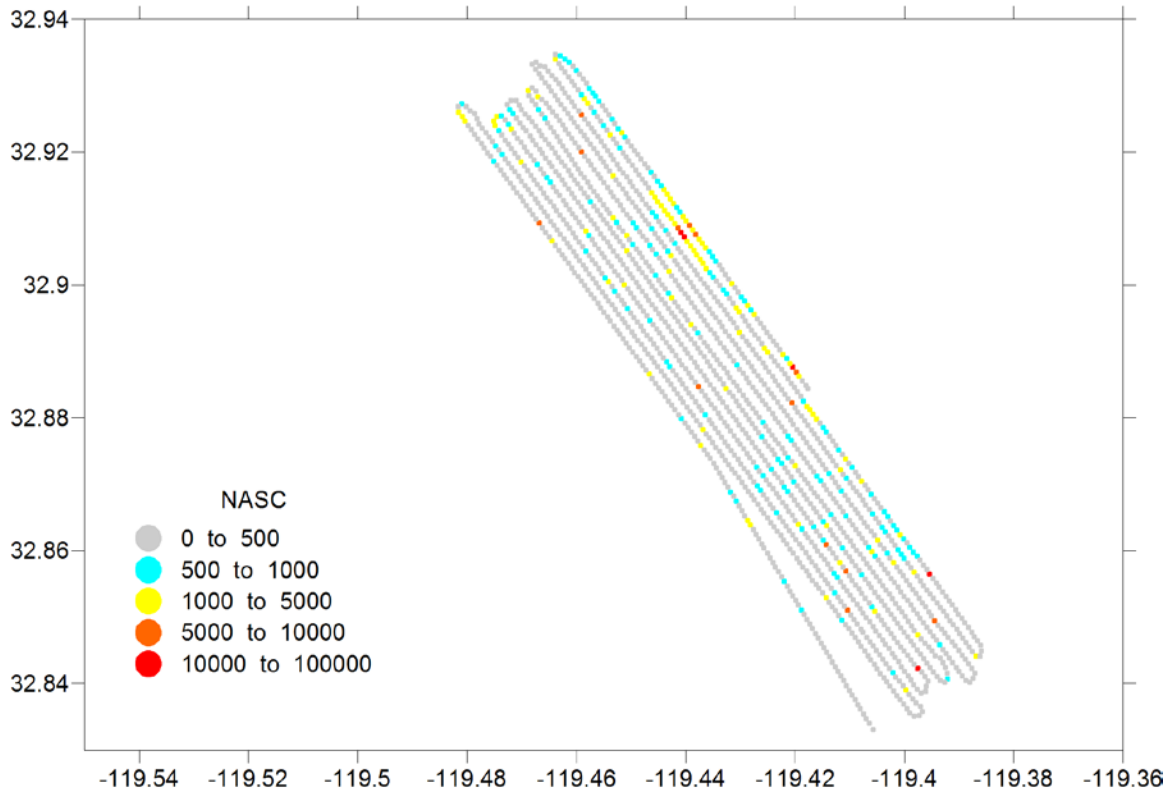

Figure 1.19. Cherry Bank Grid 3 multi-beam (021203) area backscatter coefficients (s_a ; m^2/m^2) attributed to seabed type.

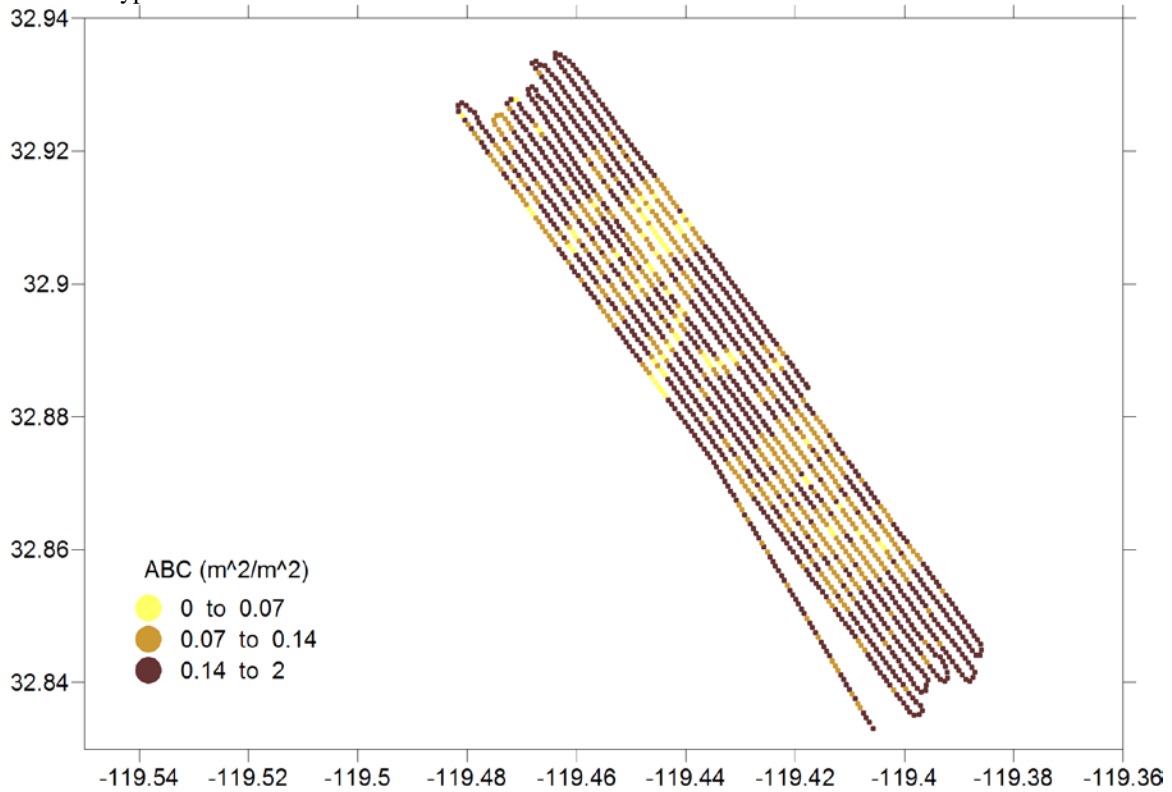

Figure 1.20. Cherry Bank Grid 4 (021203) 3-D image of bathymetry (m) and S_v of rockfishes (dB).
[View eastwards].

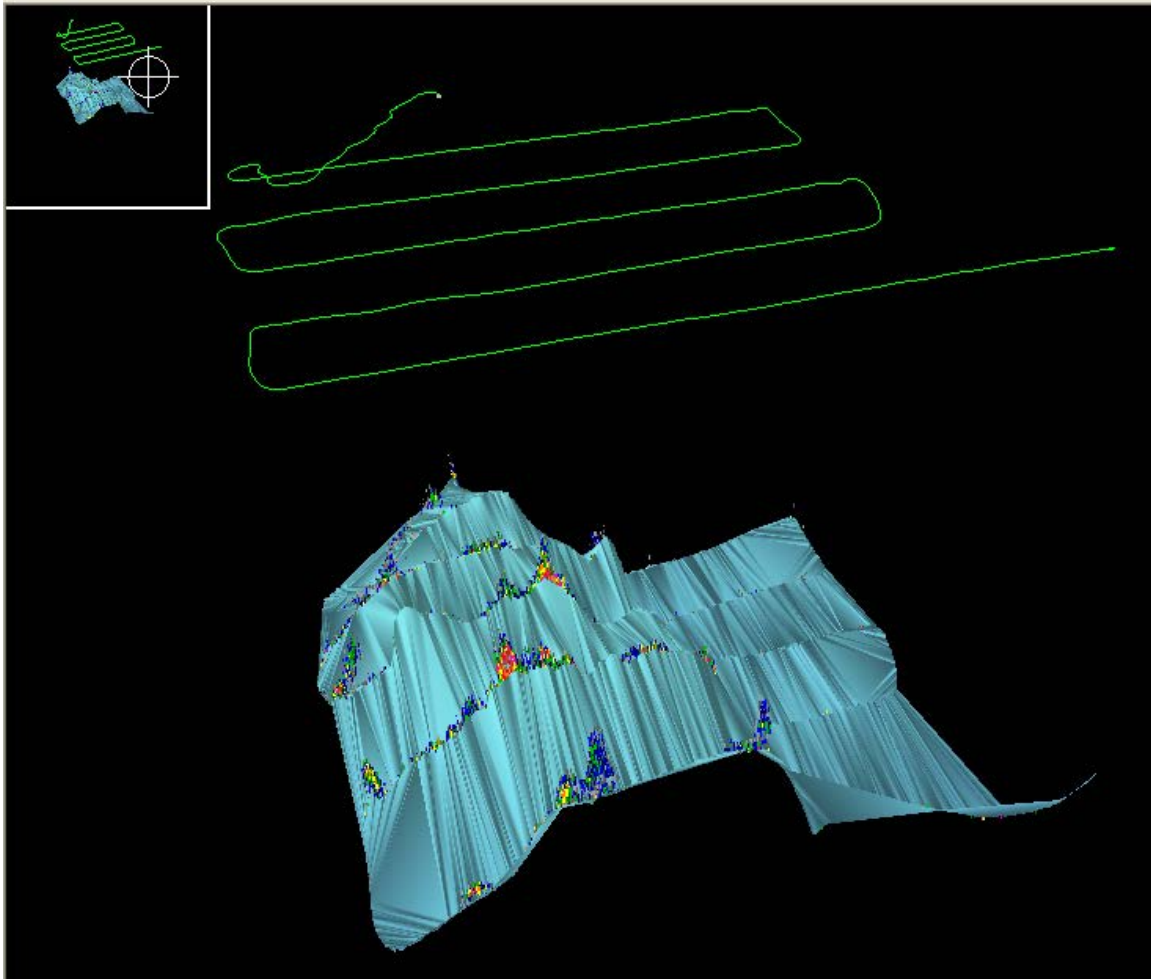

Figure 1.21. Cherry Bank Grid 4 (021203) distribution of s_A ($m^2/n.mi.^2$) attributed to rockfishes.

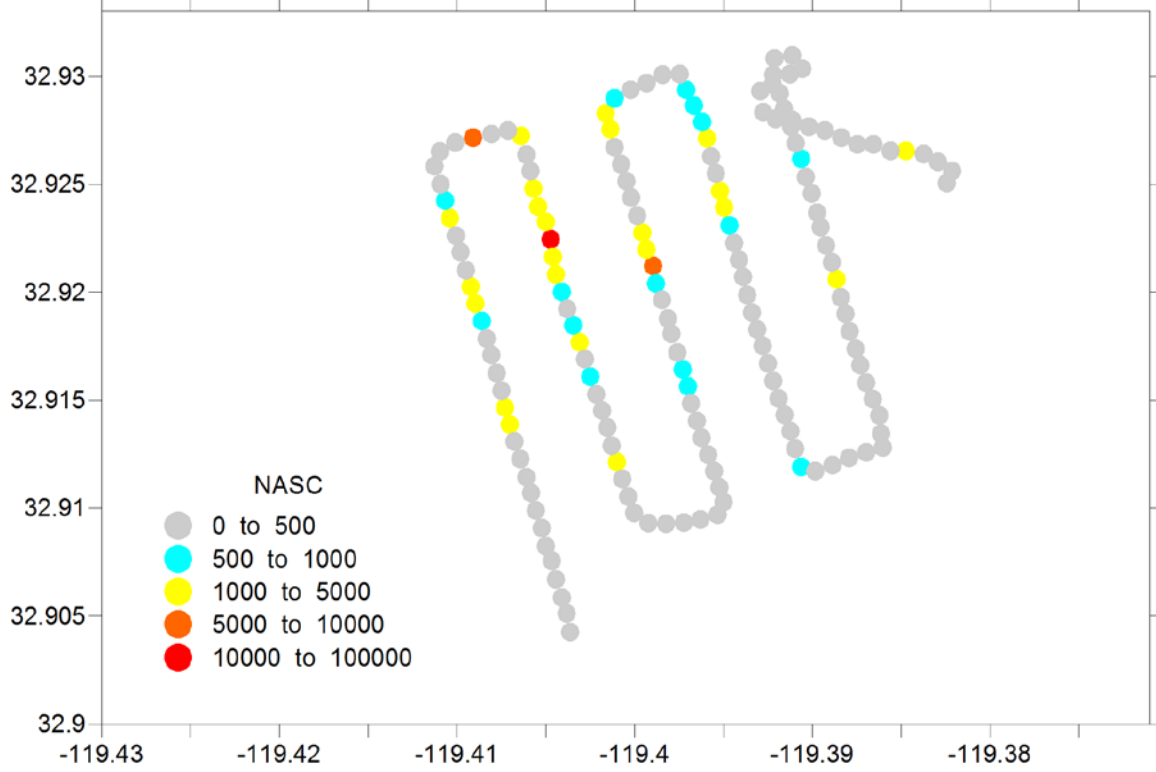

Figure 1.22. Cherry Bank Grid 4 (021203) area backscatter coefficients (s_a ; m^2/m^2) attributed to seabed type.

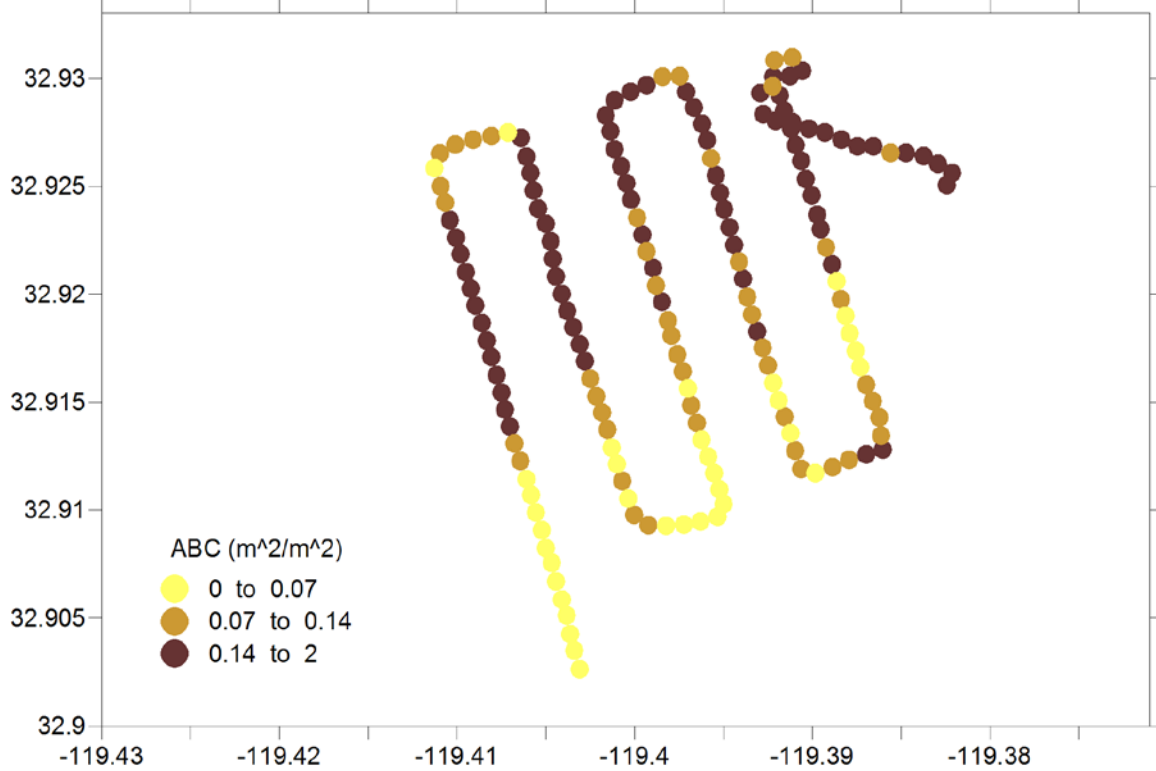

Figure 1.23. Forty-Three Fathom Bank (031203) 3-D image of bathymetry (m) and S_v of rockfishes (dB).

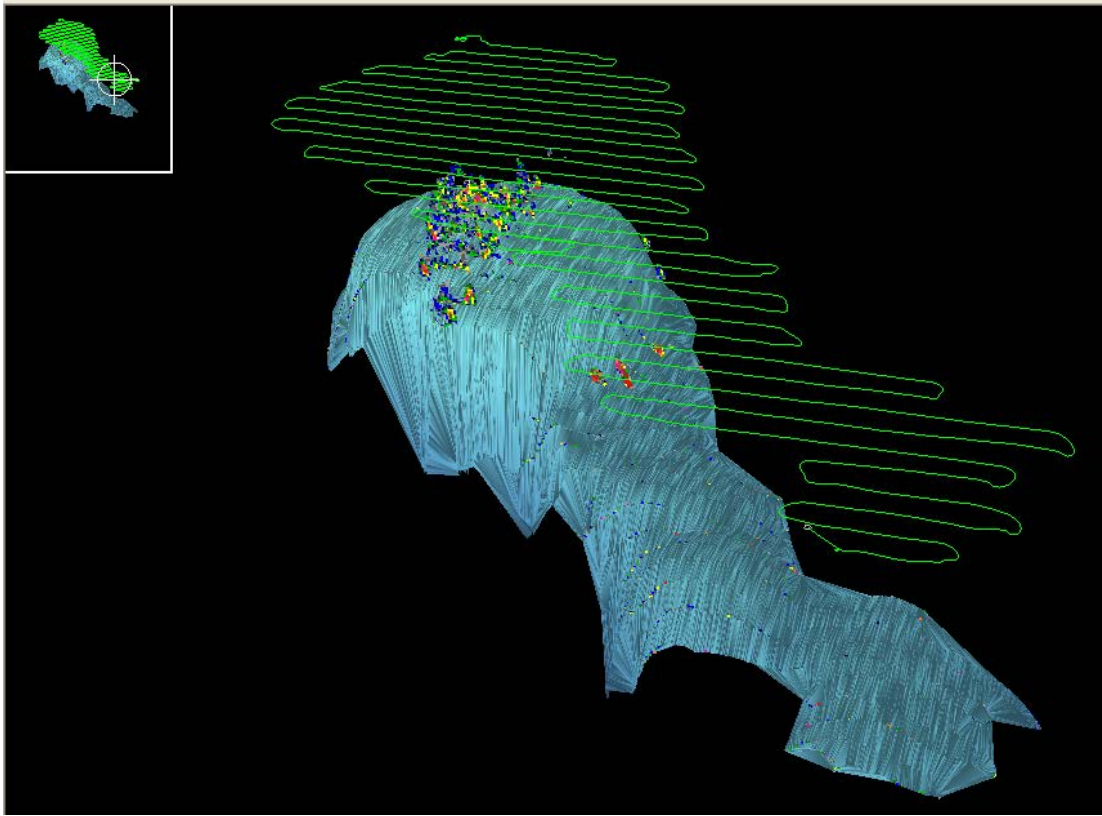

Figure 1.24. Forty-Three Fathom Bank (031203) distribution of s_A ($m^2/n.mi.^2$) attributed to rockfishes.

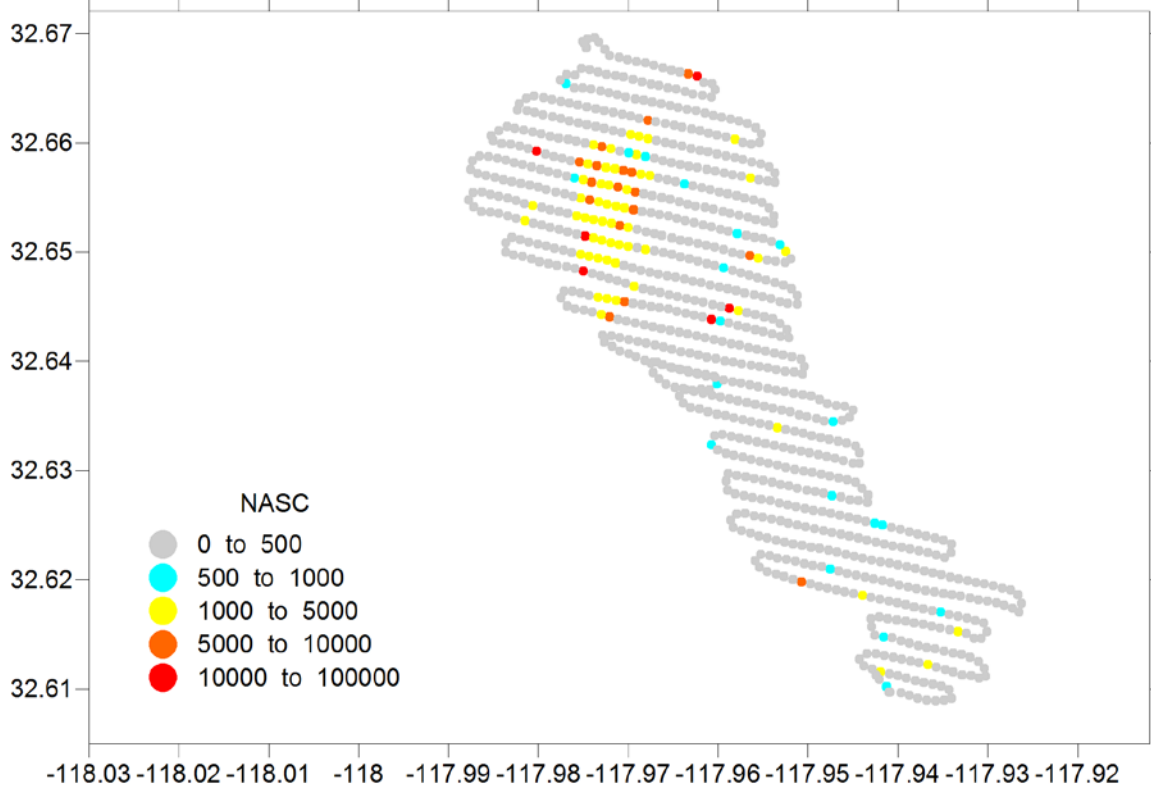
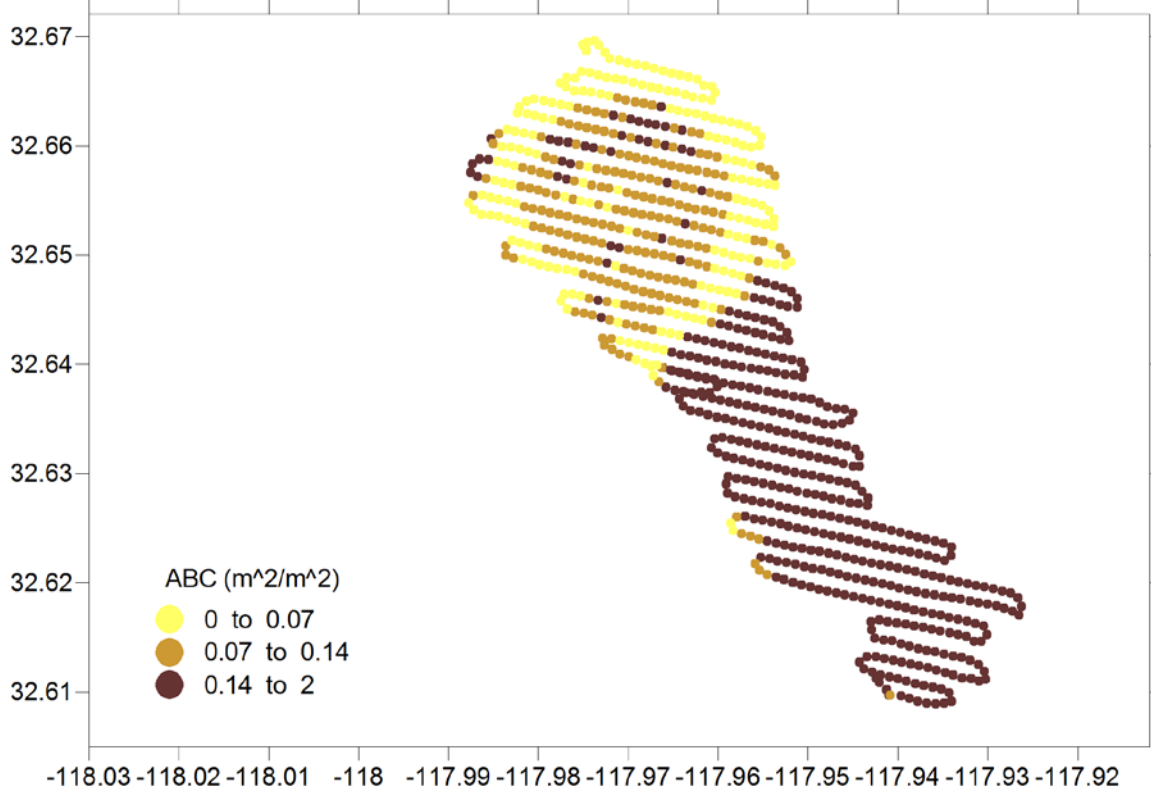

Figure 1.25. Forty-Three Fathom Bank (031203) area backscatter coefficients (s_d ; m^2/m^2) attributed to seabed type.



Cruise Leg 4

Cherry Bank: Very similar to the image and maps from daytime survey of this area during the previous cruise leg (Figs. 1.14, 1.15 and 1.16), the higher densities of rockfishes were mapped from early to late morning (0717 to 1153 PST) in the southwestern portion of the grid (Figs. 1.26 and 1.27), where the s_a indicated intermediate to high values (Fig. 1.28). Another survey conducted in the late afternoon to early evening (1544 to 1815 PST) in a different portion of this area show few rockfishes (Figs. 1.29 and 1.30), even in putative rocky areas (Fig. 1.31)

San Clemente Island: Few rockfishes and some pelagic schooling fishes were mapped during this daytime (1008 to 1246 PST) survey (Figs. 1.32 and 1.33). Most of the fish were mapped in the shallower eastern region characterized by intermediate s_a values (Fig. 1.34). The survey area is located at the northwestern edge of San Clemente Island.

Figure 1.26. Cherry Bank Grid 1 (270104) 3-D image of bathymetry (m) and S_v of rockfishes (dB).

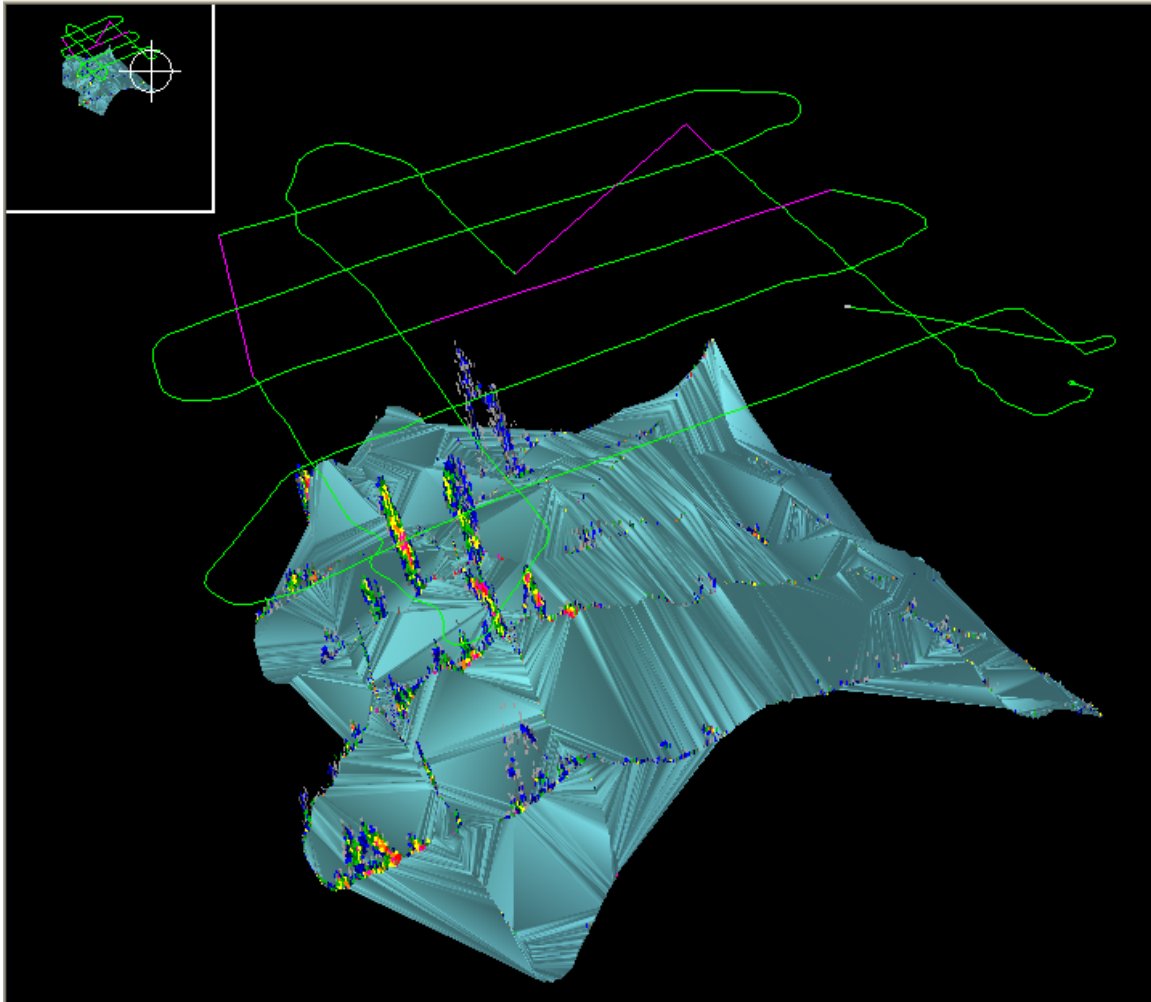

Figure 1.27. Cherry Bank Grid 1 (270104) distribution of s_A ($m^2/n.mi.^2$) attributed to rockfishes.

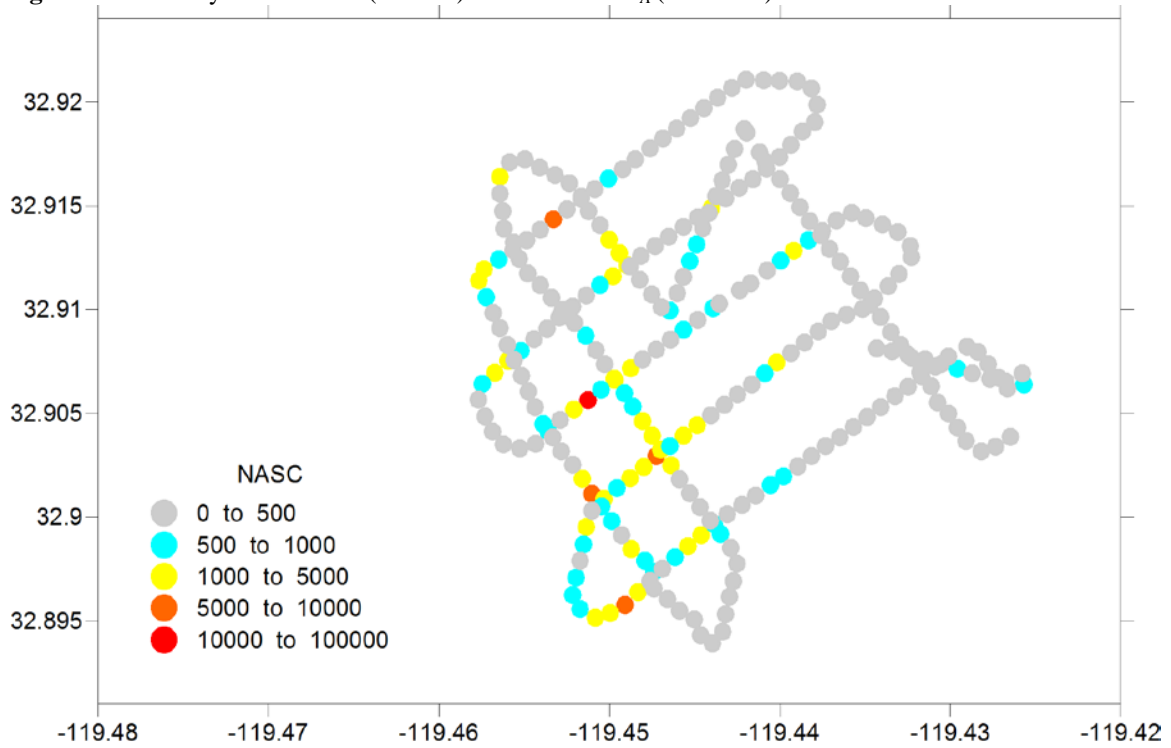

Figure 1.28. Cherry Bank Grid 1 (270104) area backscatter coefficients (s_a ; m^2/m^2) attributed to seabed type.

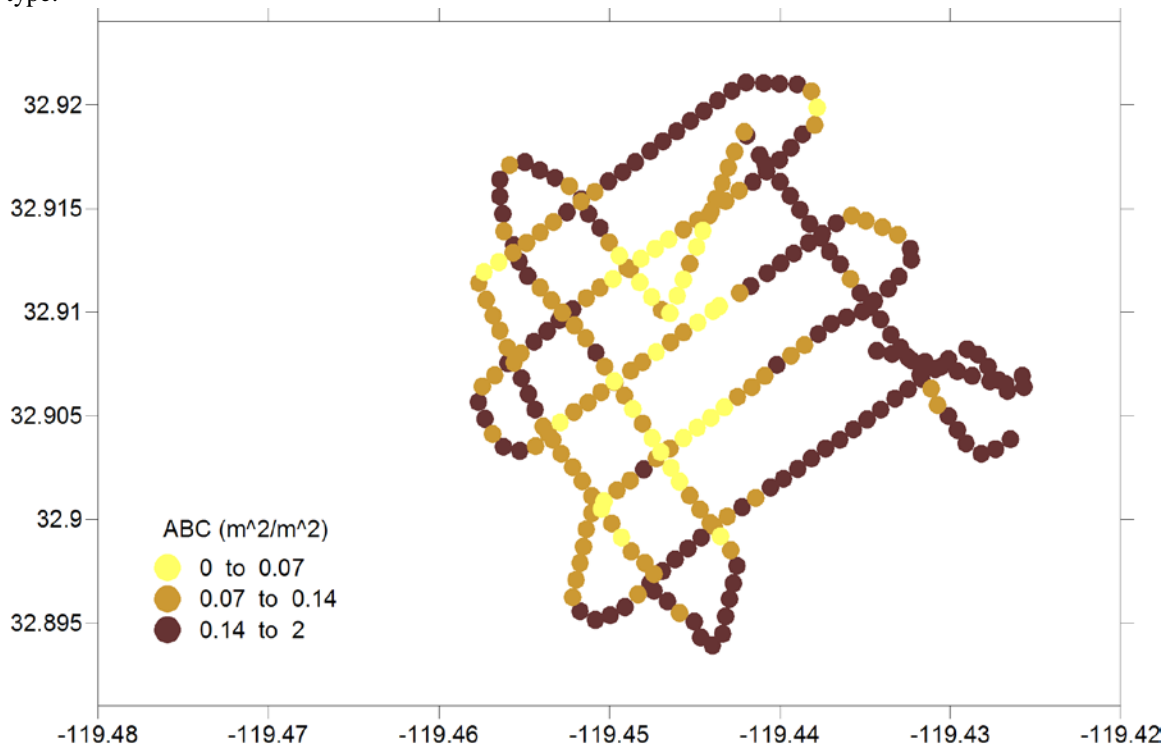

Figure 1.29. Cherry Bank Grid 2 (270104) 3-D image of bathymetry (m) and S_v of rockfishes (dB).

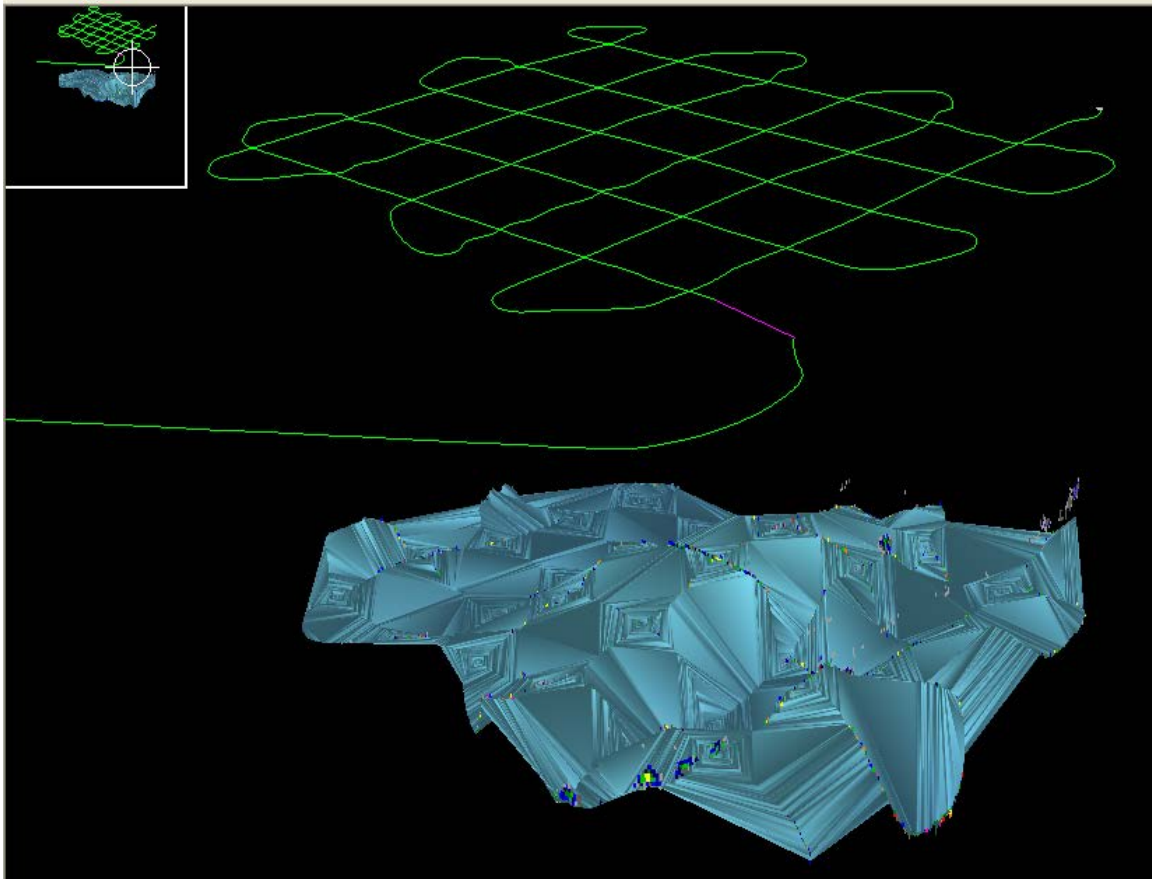

Figure 1.30. Cherry Bank Grid 2 (270104) distribution of s_A ($m^2/n.mi.^2$) attributed to rockfishes.

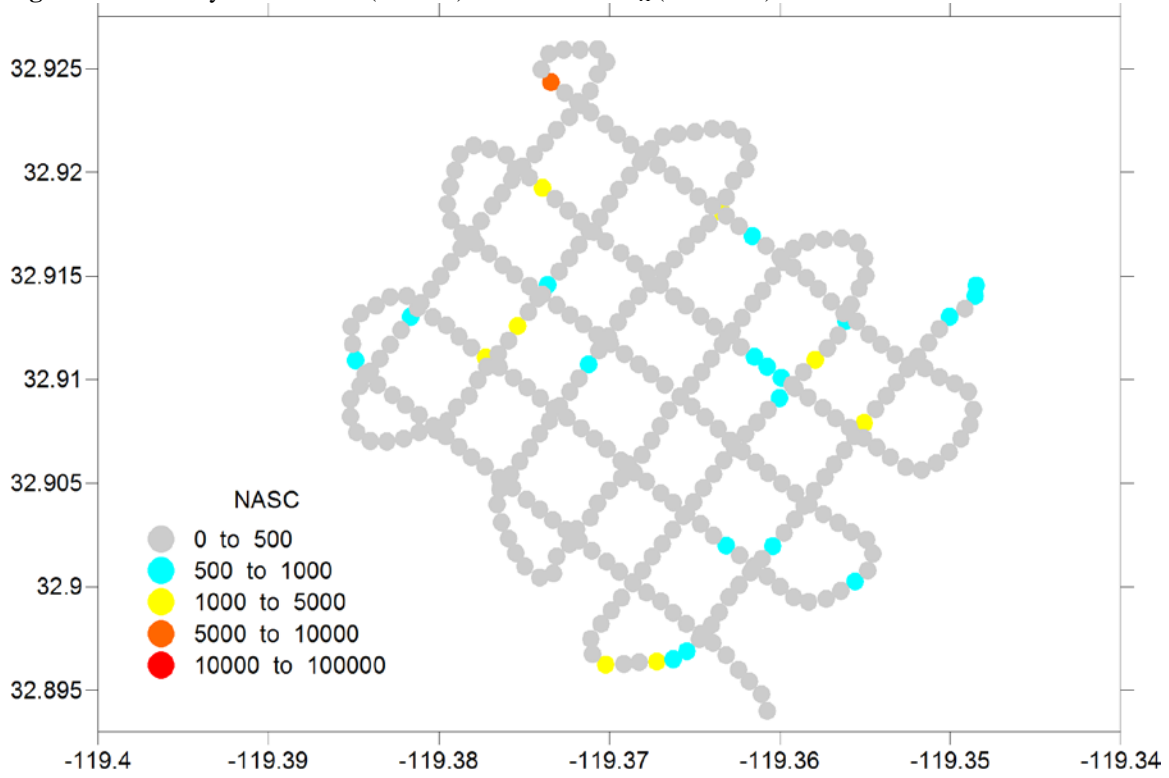

Figure 1.31. Cherry Bank Grid 2 (270104) area backscatter coefficients (s_b ; m^2/m^2) attributed to seabed type.

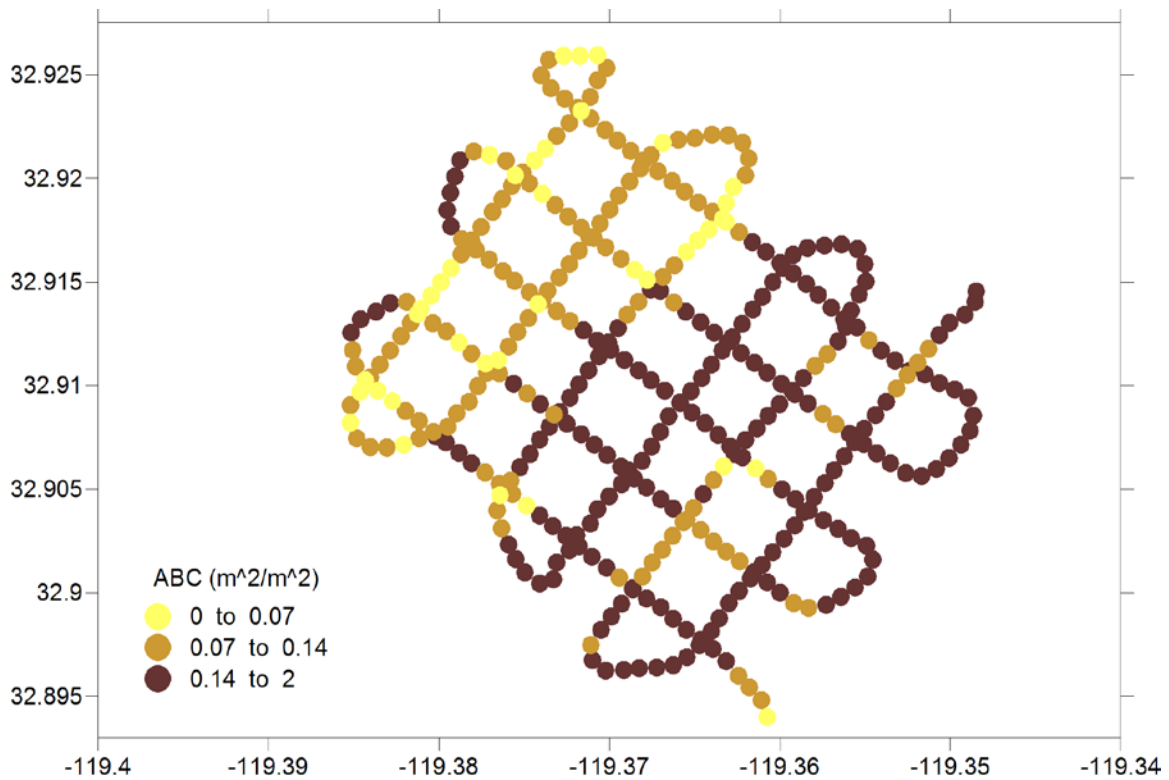

Figure 1.32. San Clemente Island Grid 1 (280104) 3-D image of bathymetry (m) and S_v of rockfishes (dB).

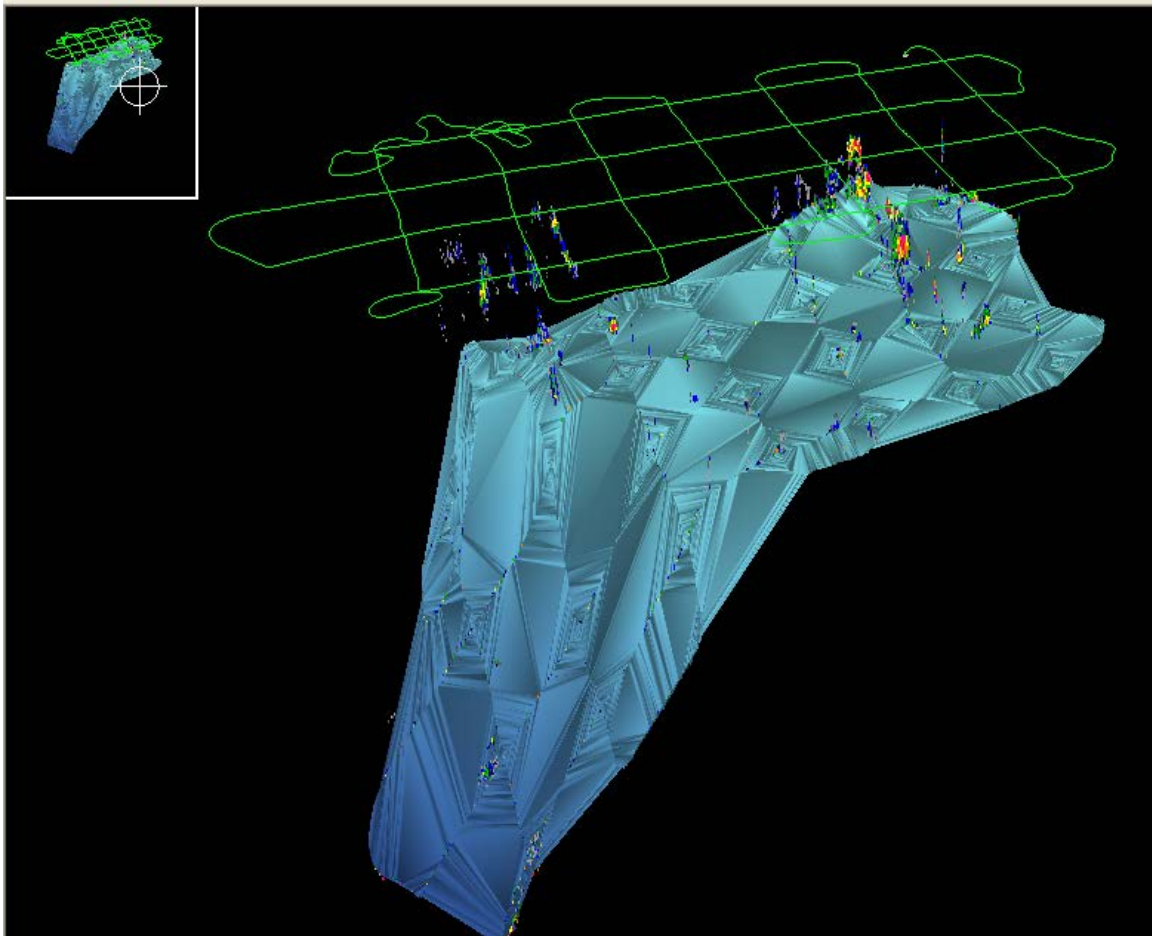

Figure 1.33. San Clemente Island Grid 1 (280104) distribution of s_A ($m^2/n.mi.^2$) attributed to rockfishes.

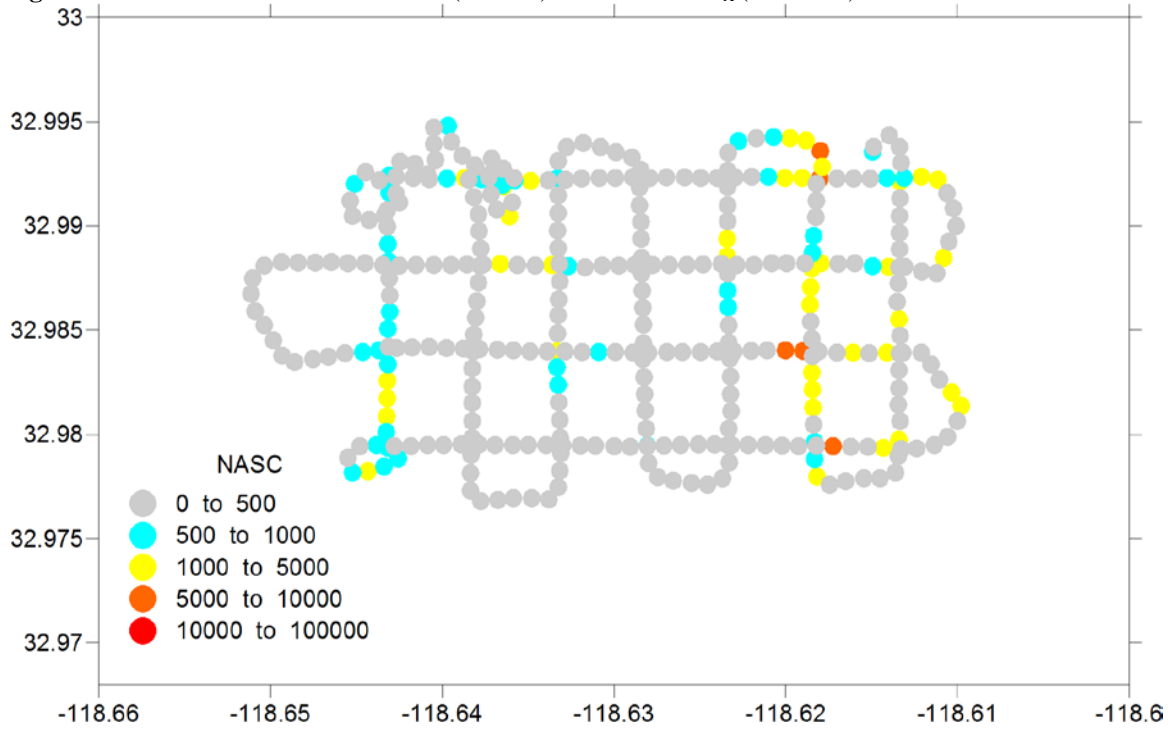
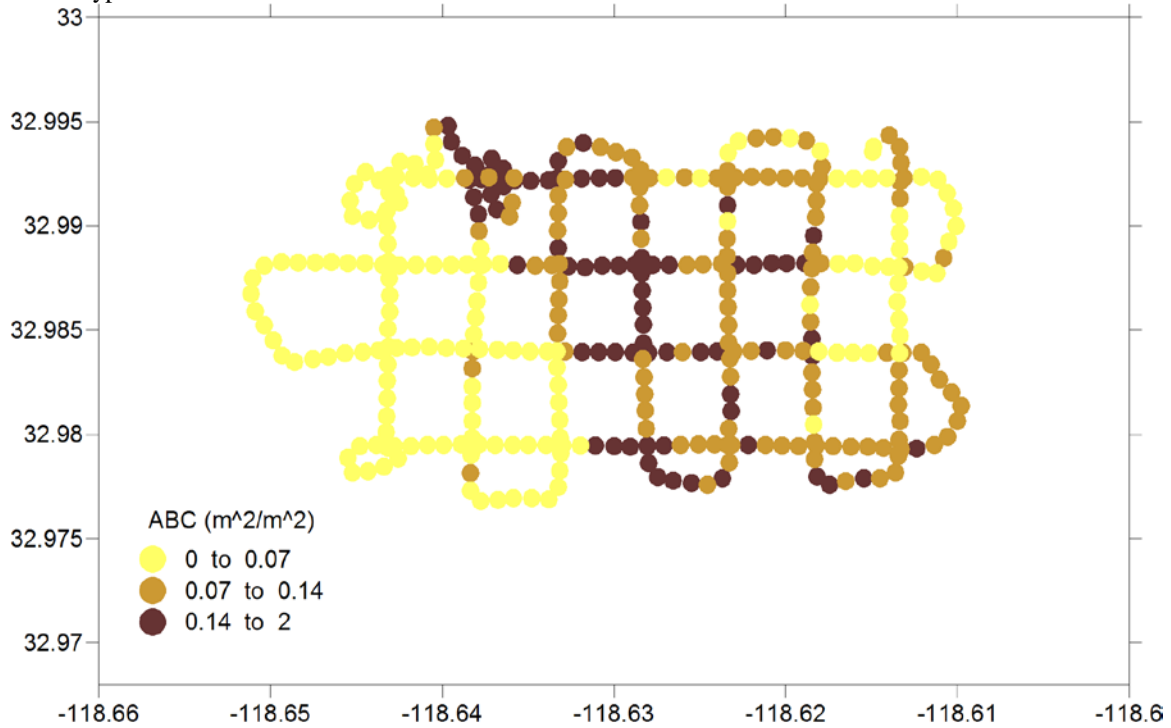

Figure 1.34. San Clemente Island Grid 1 (280104) area backscatter coefficients (s_a ; m^2/m^2) attributed to seabed type.



Cruise Leg 5

Forty-Three Fathom Bank: Surveys were conducted at two sites: one from mid to late afternoon (1507 to 1725 PST); the other from early to late morning (0804 to 1037 PST). The first survey again indicated high densities of rockfishes near the rocky areas at the top of the bank, extending to the edge of the bank in the southwest (Figs. 1.35, 1.36 and 1.37). The second survey mapped dense schools of pelagic fish on the eastern lee edge of the bank (Figs. 1.38, 1.39 and 1.40).

Figure 1.35. Forty-Three Fathom Bank Grid 2 (060304) 3-D image of bathymetry (m) and S_v of rockfishes (dB).

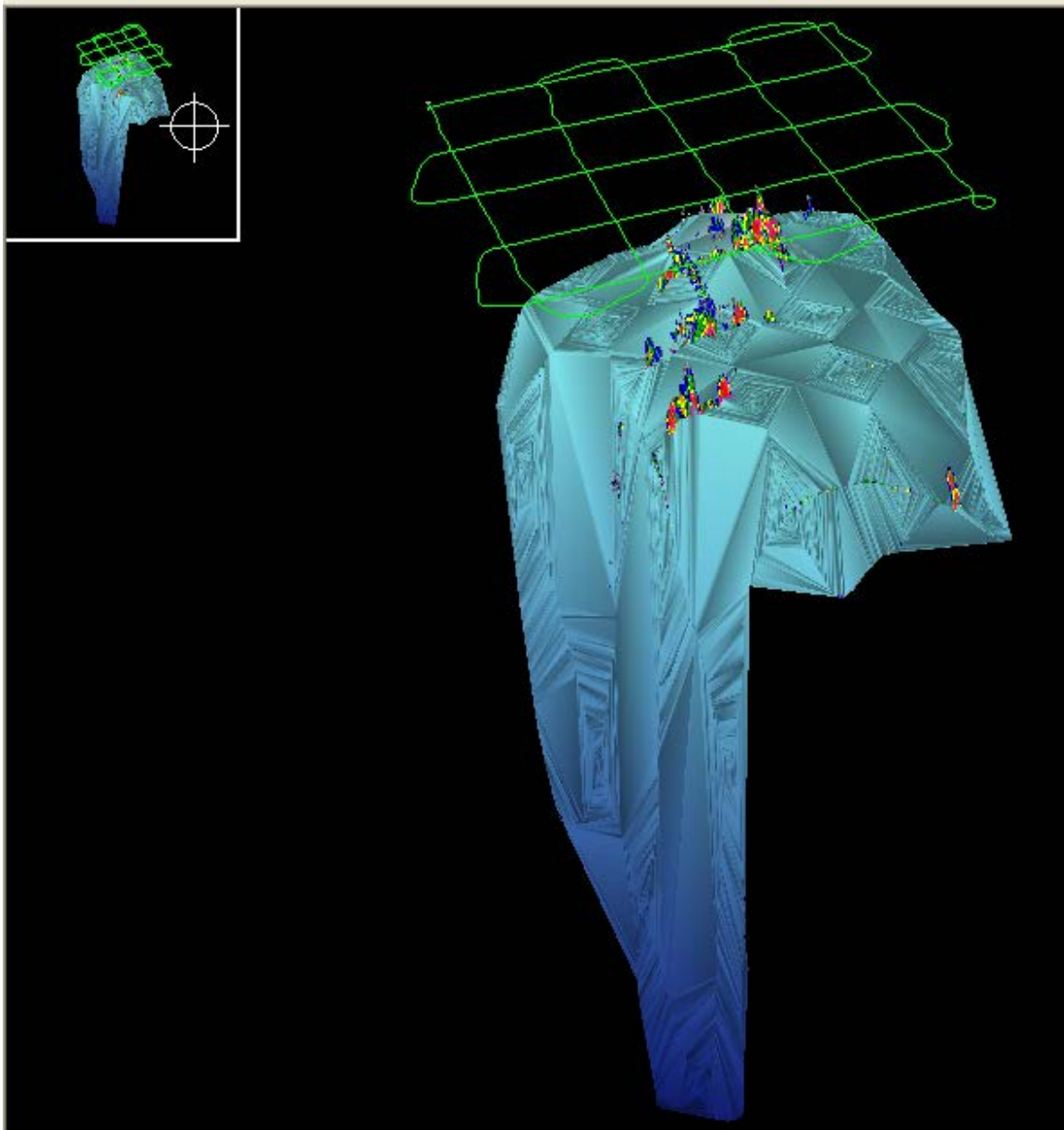

Figure 1.36. Forty-Three Fathom Bank Grid 2 (060304) distribution of s_A ($m^2/n.mi.^2$) attributed to rockfishes.

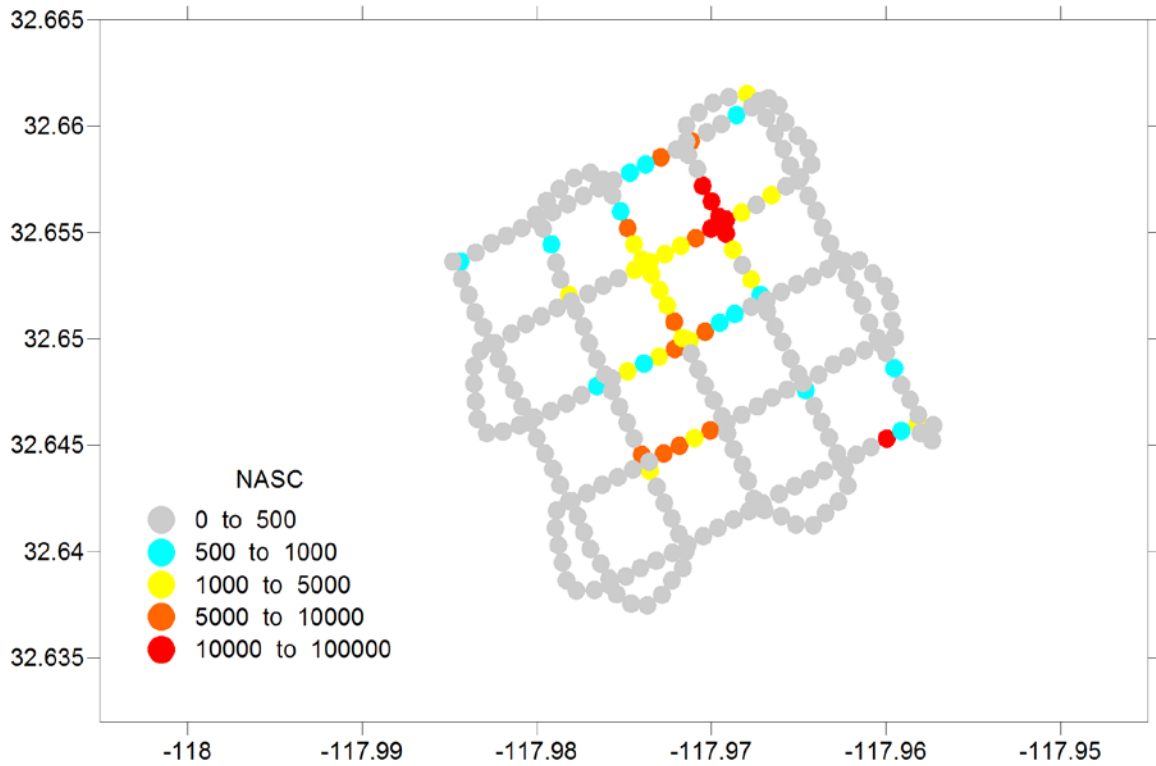

Figure 1.37. Forty-Three Fathom Bank Grid 2 (060304) area backscatter coefficients (s_a ; m^2/m^2) attributed to seabed type.

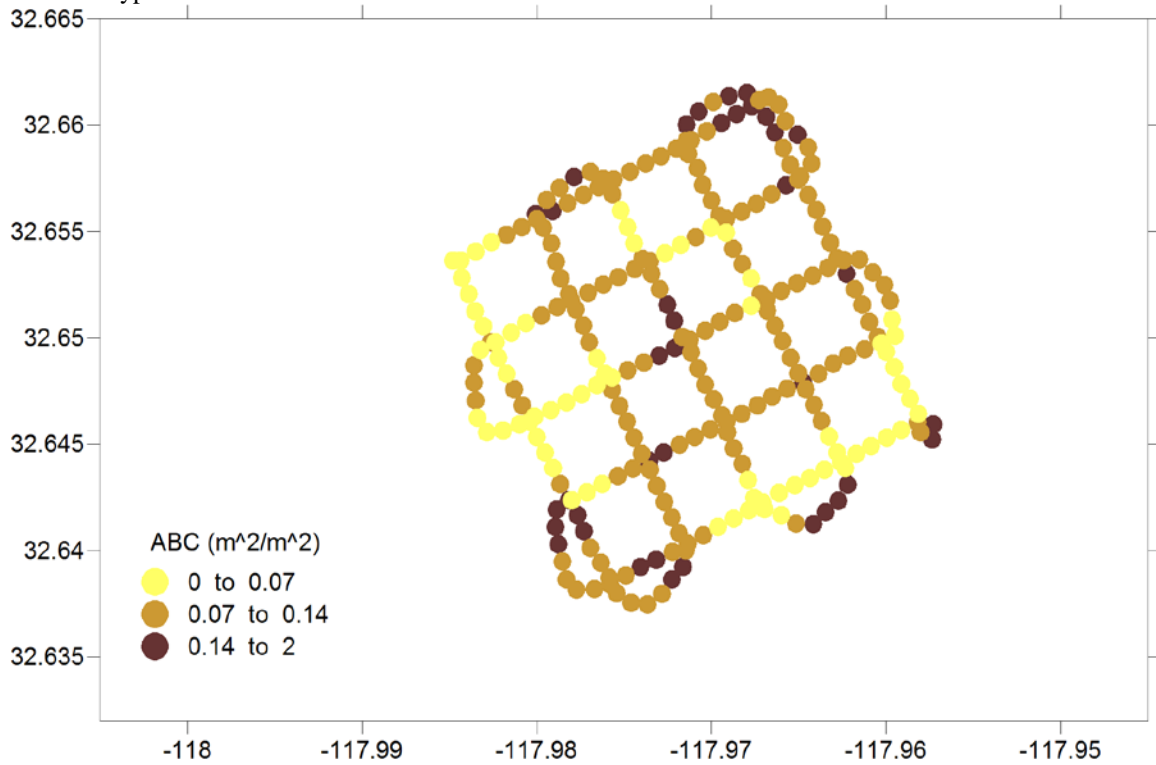

Figure 1.38. Forty-Three Fathom Bank Grid 3 (070304) 3-D image of bathymetry (m) and S_v of rockfishes (dB). [View westwards].

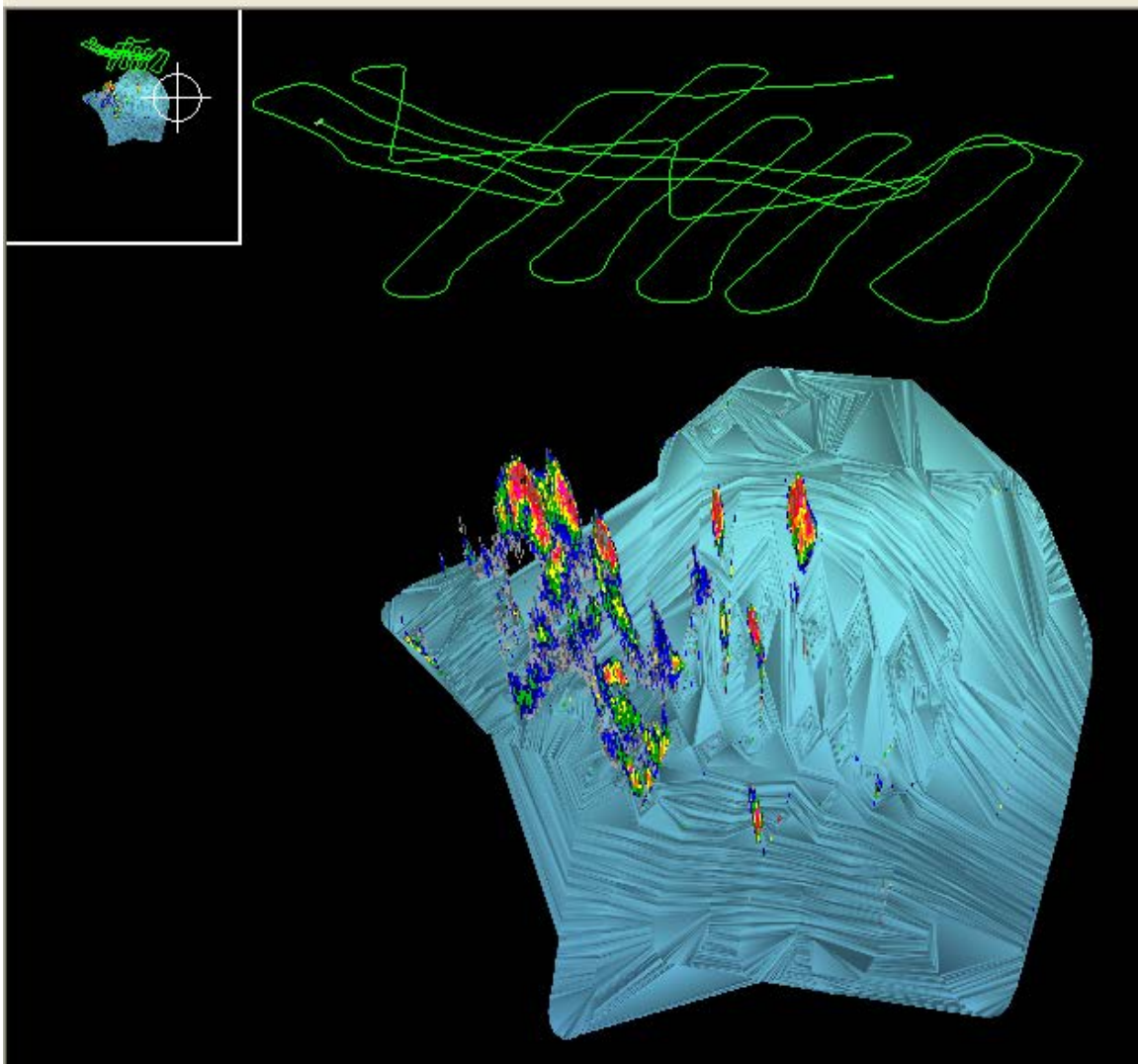

Figure 1.39. Forty-Three Fathom Bank Grid 3 (070304) distribution of s_A ($m^2/n.mi.^2$) attributed to rockfishes.

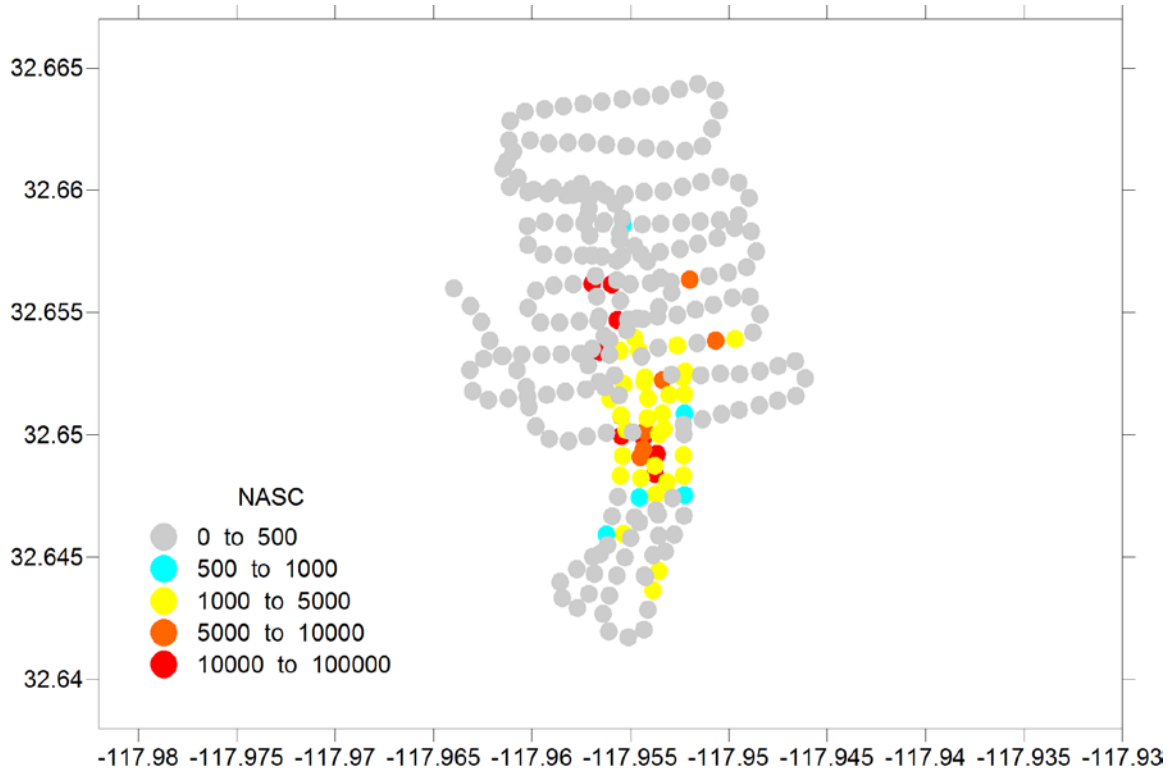
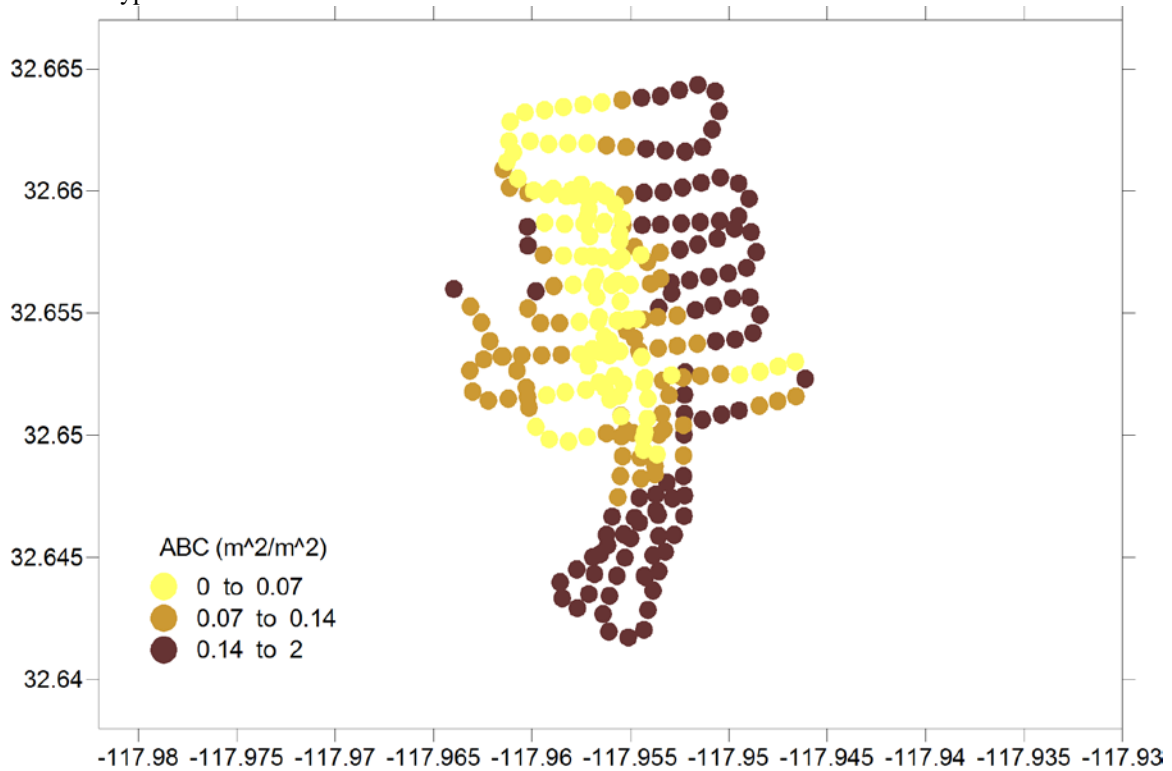

Figure 1.40. Forty-Three Fathom Bank Grid 3 (070304) area backscatter coefficients (s_a ; m^2/m^2) attributed to seabed type.



Cruise Leg 6

Forty-Three Fathom Bank: During this survey conducted from early- to mid-morning (0721 to 0938 PST), high-densities of rockfishes were mapped near the center of the bank and pelagic fish schools were found over the top of the bank and on the southeastern lee slope (Figs. 1.41, 1.42 and 1.43).

Figure 1.41. Forty-Three Fathom Bank (120304) 3-D image of bathymetry (m) and S_v of rockfishes (dB).

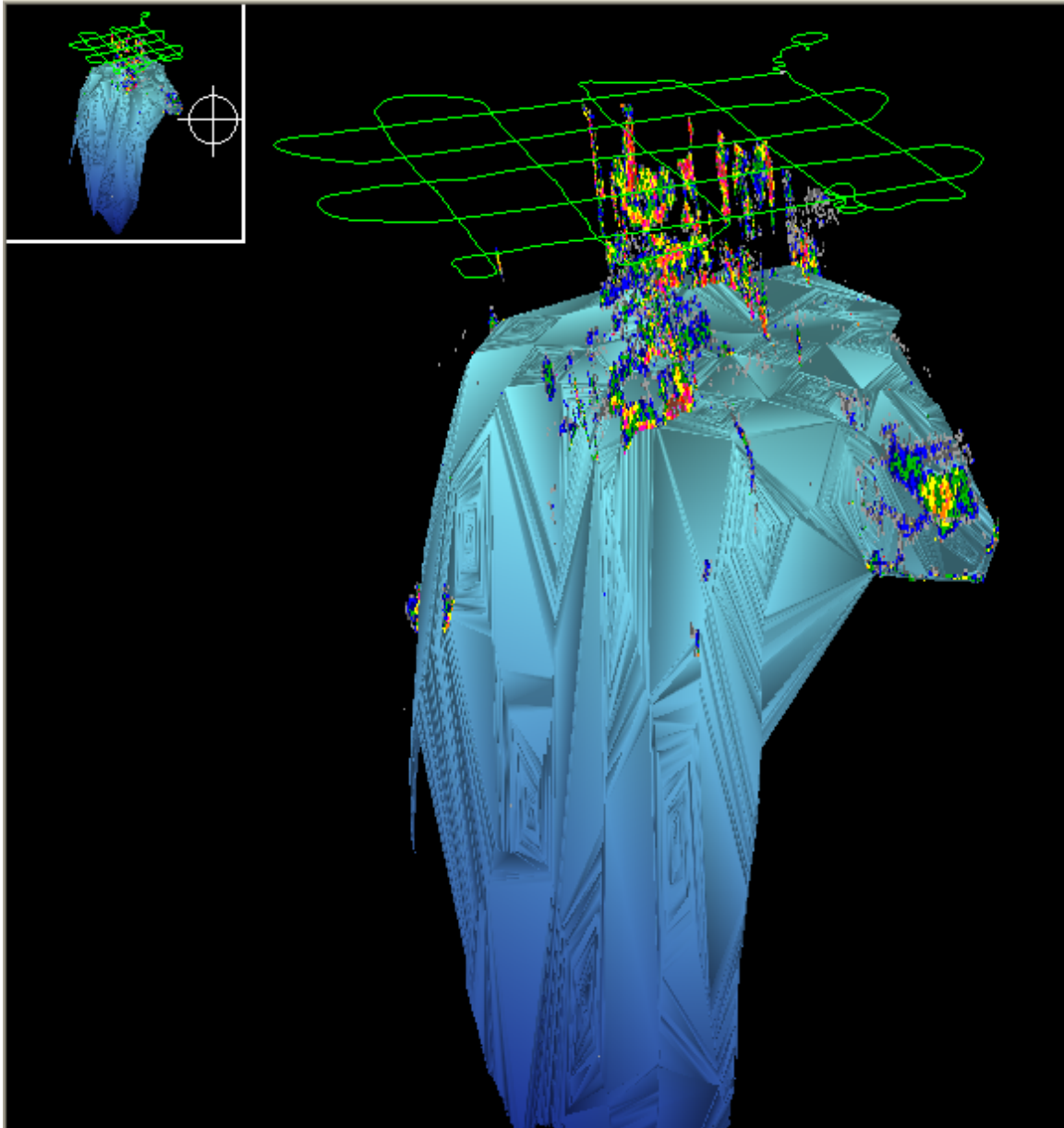

Figure 1.42. Forty-Three Fathom Bank (120304) distribution of s_A ($m^2/n.mi.^2$) attributed to rockfishes.

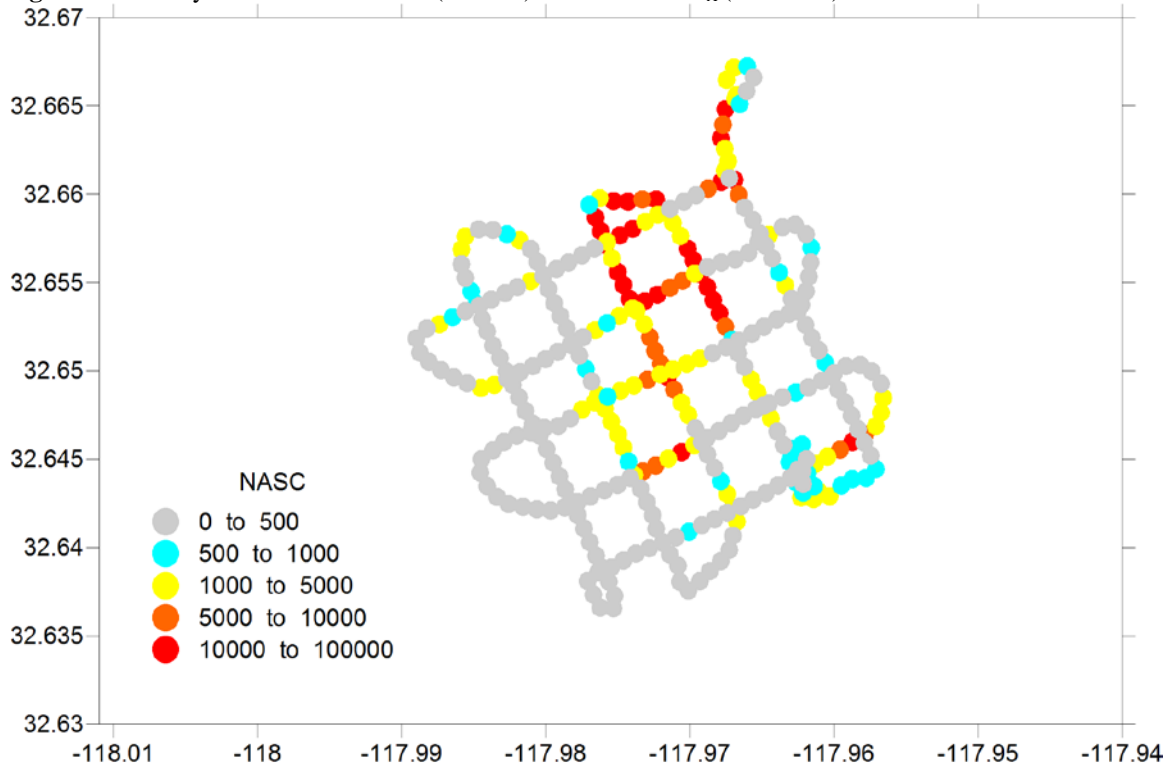
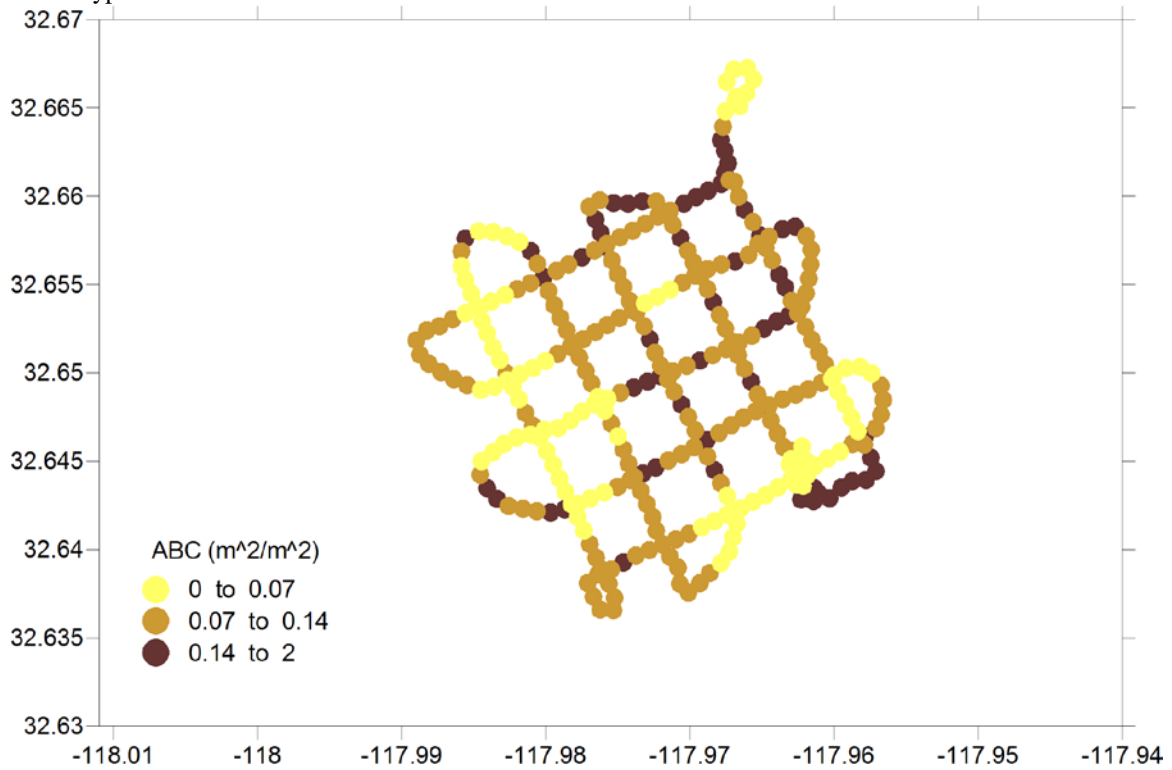

Figure 1.43. Forty-Three Fathom Bank (120304) area backscatter coefficients (s_a ; m^2/m^2) attributed to seabed type.



Cruise Leg 7

Tanner Bank: An area was surveyed during two crepuscular periods: from late afternoon to early evening (1712 to 1919 PST); and from early to mid-morning (0728 to 0938 PST). Relatively few fish were mapped in the area during dusk (**Figs. 1.44, 1.45 and 1.46**) compared to during dawn (**Figs. 1.47, 1.48 and 1.49**), but most of the schools in the latter survey appeared to be pelagic fishes.

Kidney Bank: This bank was nearly void of fish, even during the mid morning to noon survey (1036 to 1257 PST) (**Figs. 1.50, 1.51 and 1.52**).

Forty-Three Fathom Bank: During the evening hours (1710 to 1932 PST), few rockfishes were mapped, even in the rocky areas near the top of the bank (**Figs. 1.53, 1.54 and 1.55**).

Potato Bank: High densities of fish were ubiquitous in this area during the early to mid-morning hours (0705 to 0954 PST), with highest densities located in the western portion of the area (**Figs. 1.56, 1.57 and 1.58**).

San Nicolas Island: High densities of fish were also ubiquitous in this relatively flat area during the early to mid-morning hours (0803 to 1003 PST). The highest fish densities were located in the southwestern portion of the area (**Figs. 1.59, 1.60 and 1.61**).

Osborne Bank: The highest fish densities were mapped over a ridge in the western portion of this area (**Figs. 1.62 and 1.63**). Moderately high densities of fish were also mapped in a band across the center of the area having moderate and high s_a values (**Fig. 1.64**).

Figure 1.44. Tanner Bank Grid 1 (140304) 3-D image of bathymetry (m) and S_v of rockfishes (dB) [View westwards].

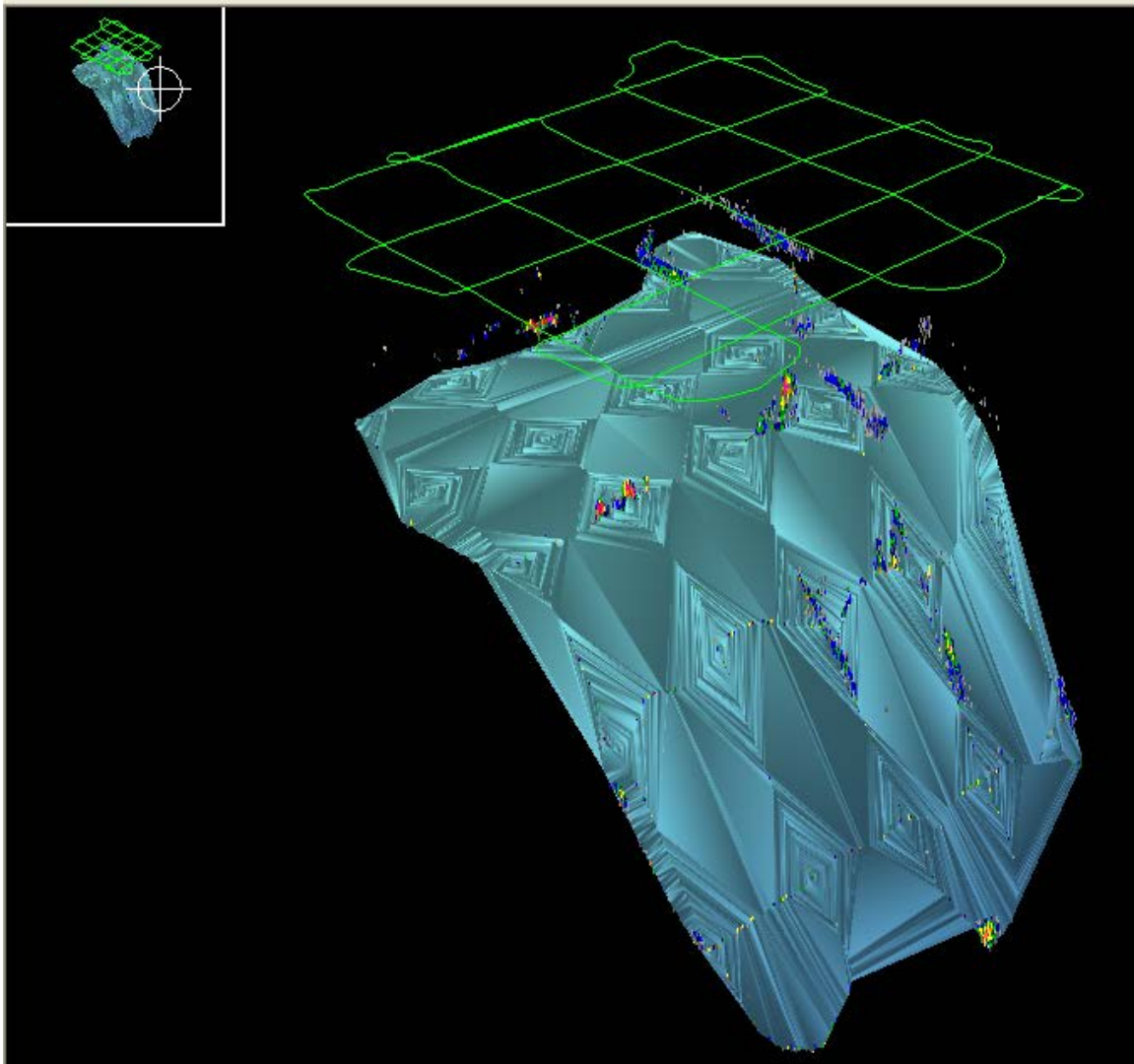

Figure 1.45. Tanner Bank Grid 1 (140304) distribution of s_A ($m^2/n.mi.^2$) attributed to rockfishes.

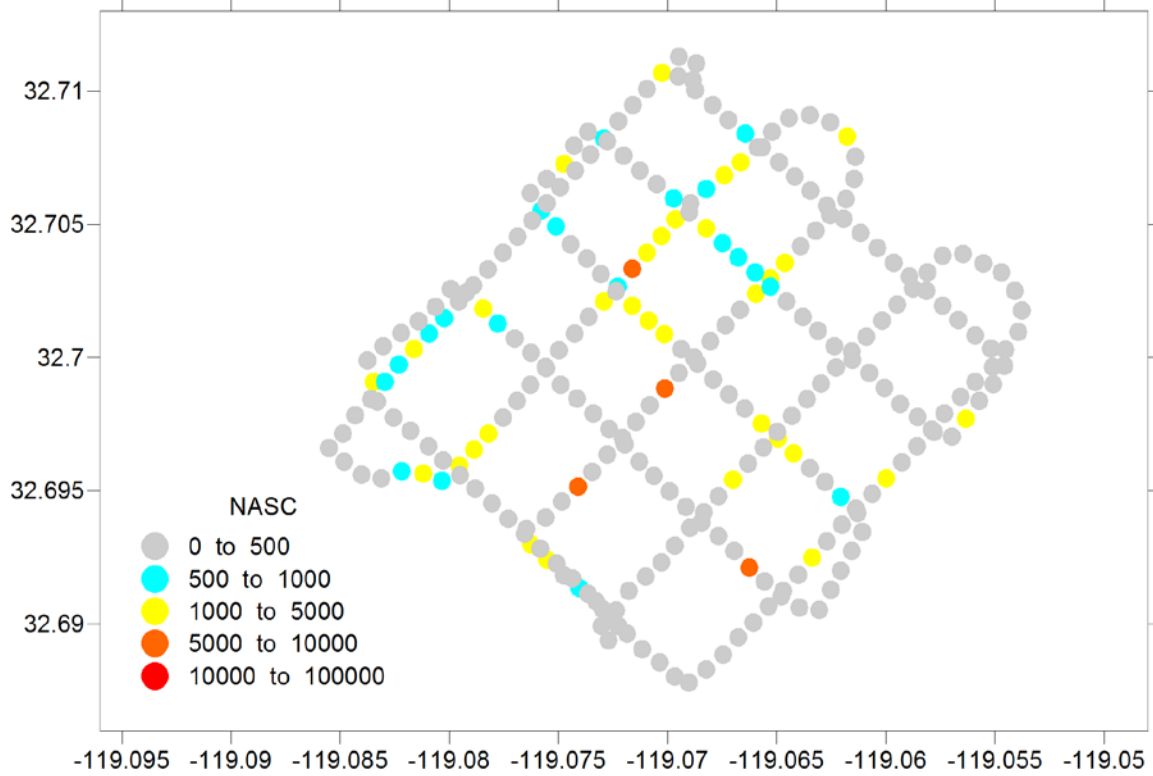

Figure 1.46. Tanner Bank Grid 1 (140304) area backscatter coefficients (s_a ; m^2/m^2) attributed to seabed type.

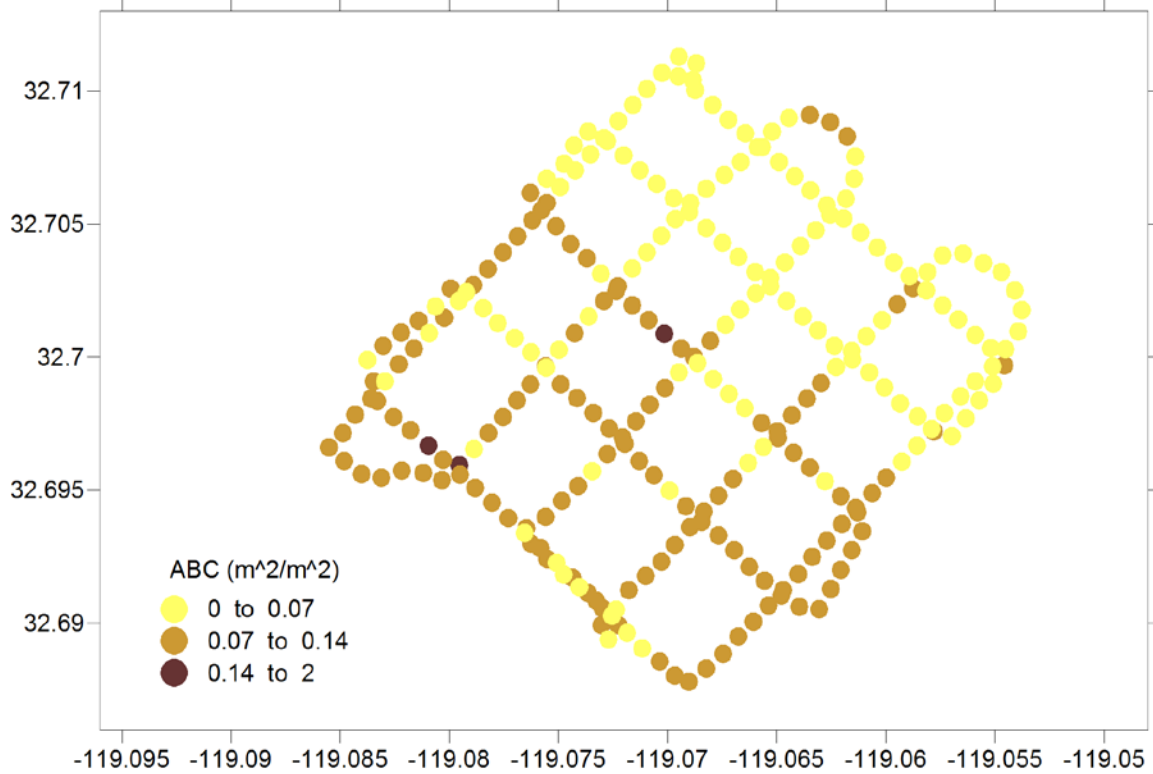

Figure 1.47. Tanner Bank Grid 2 (140304) 3-D image of bathymetry (m) and S_v of rockfishes (dB). [View westwards].

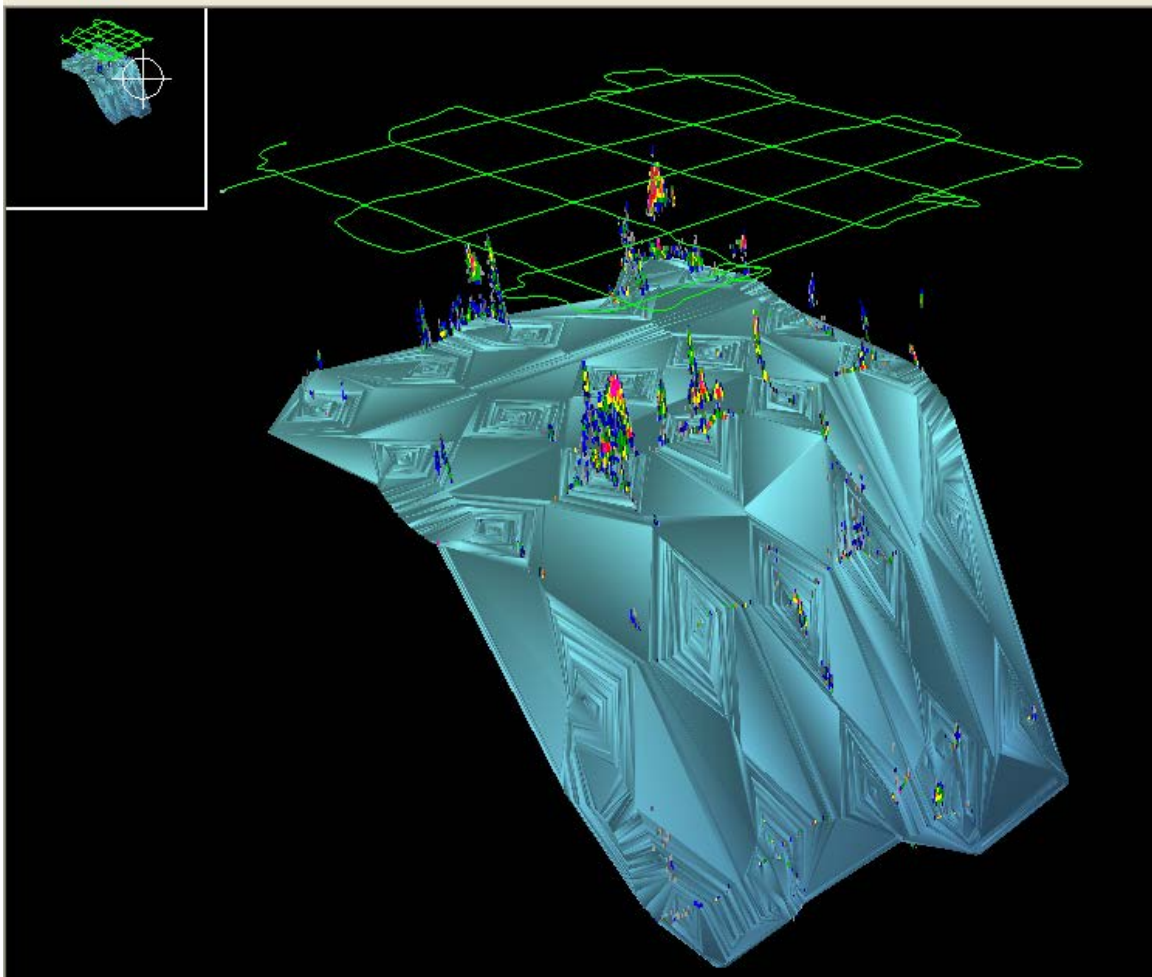

Figure 1.48. Tanner Bank Grid 2 (140304) distribution of s_A ($m^2/n.mi.^2$) attributed to rockfishes.

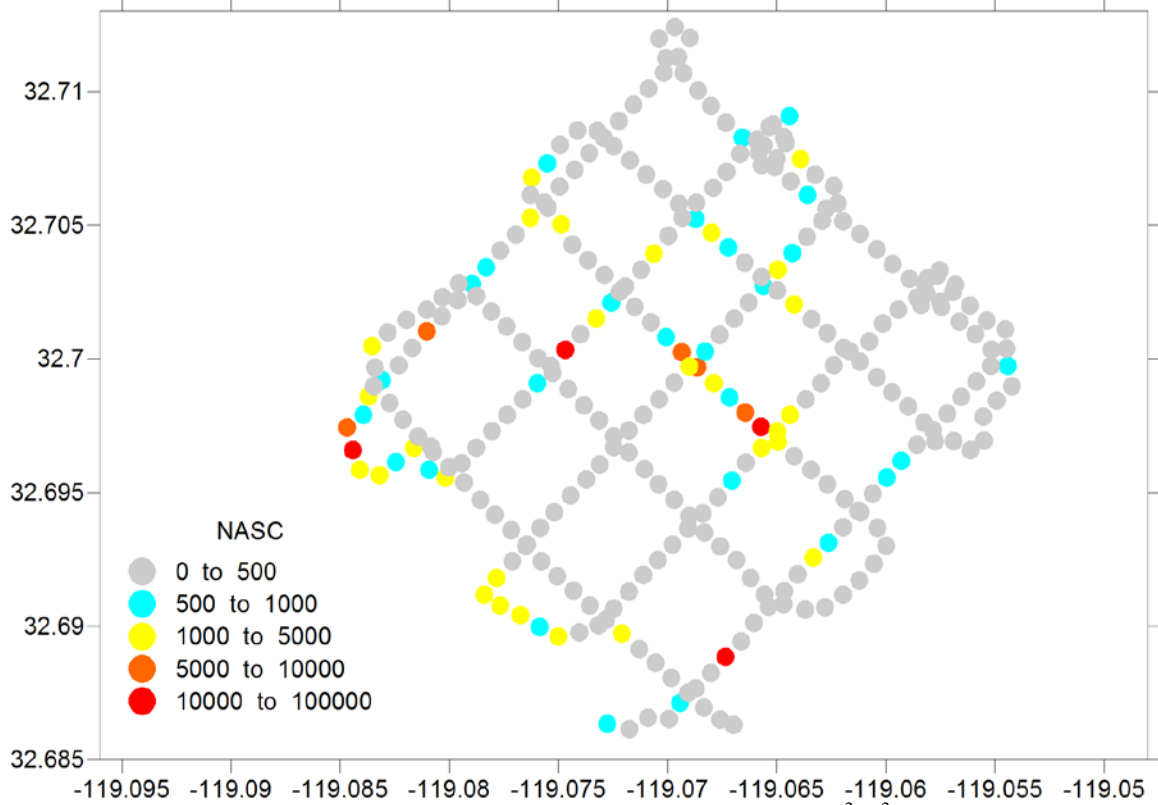

Figure 1.49. Tanner Bank Grid 2 (140304) area backscatter coefficients (s_d ; m^2/m^2) attributed to seabed type.

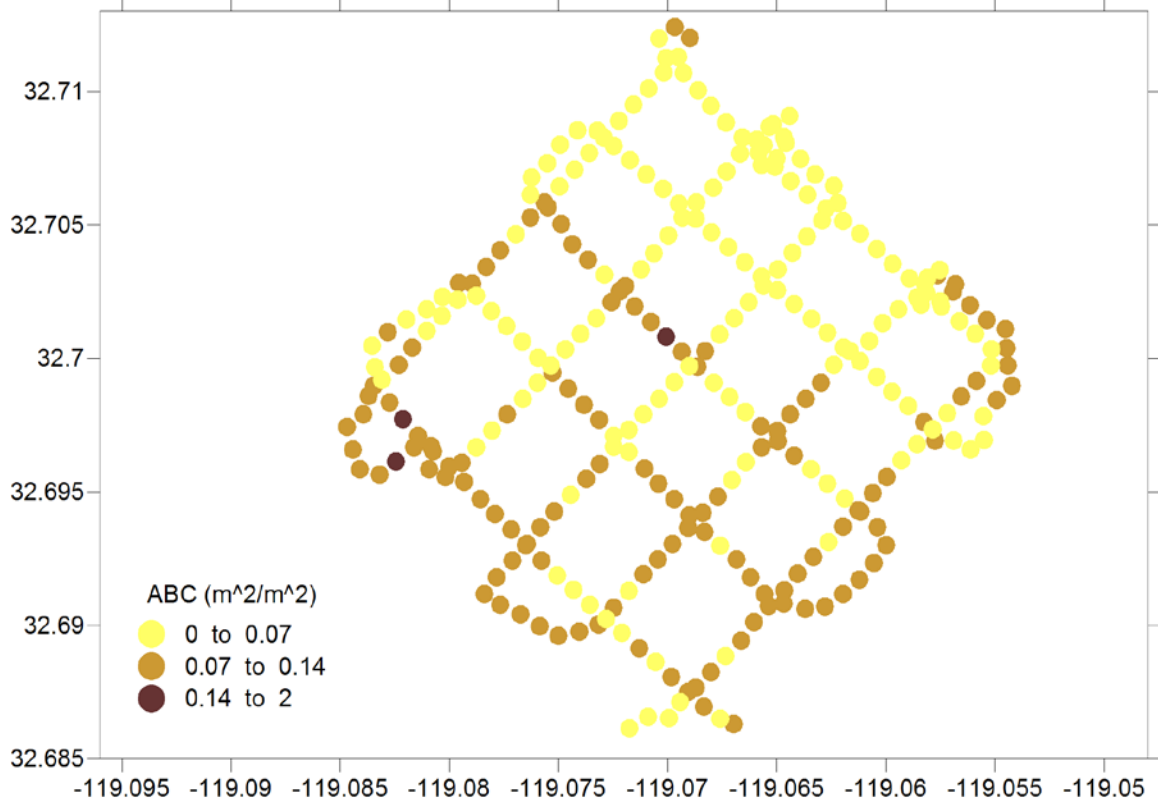

Figure 1.50. Kidney Bank (190304) 3-D image of bathymetry (m) and S_v of rockfishes (dB).

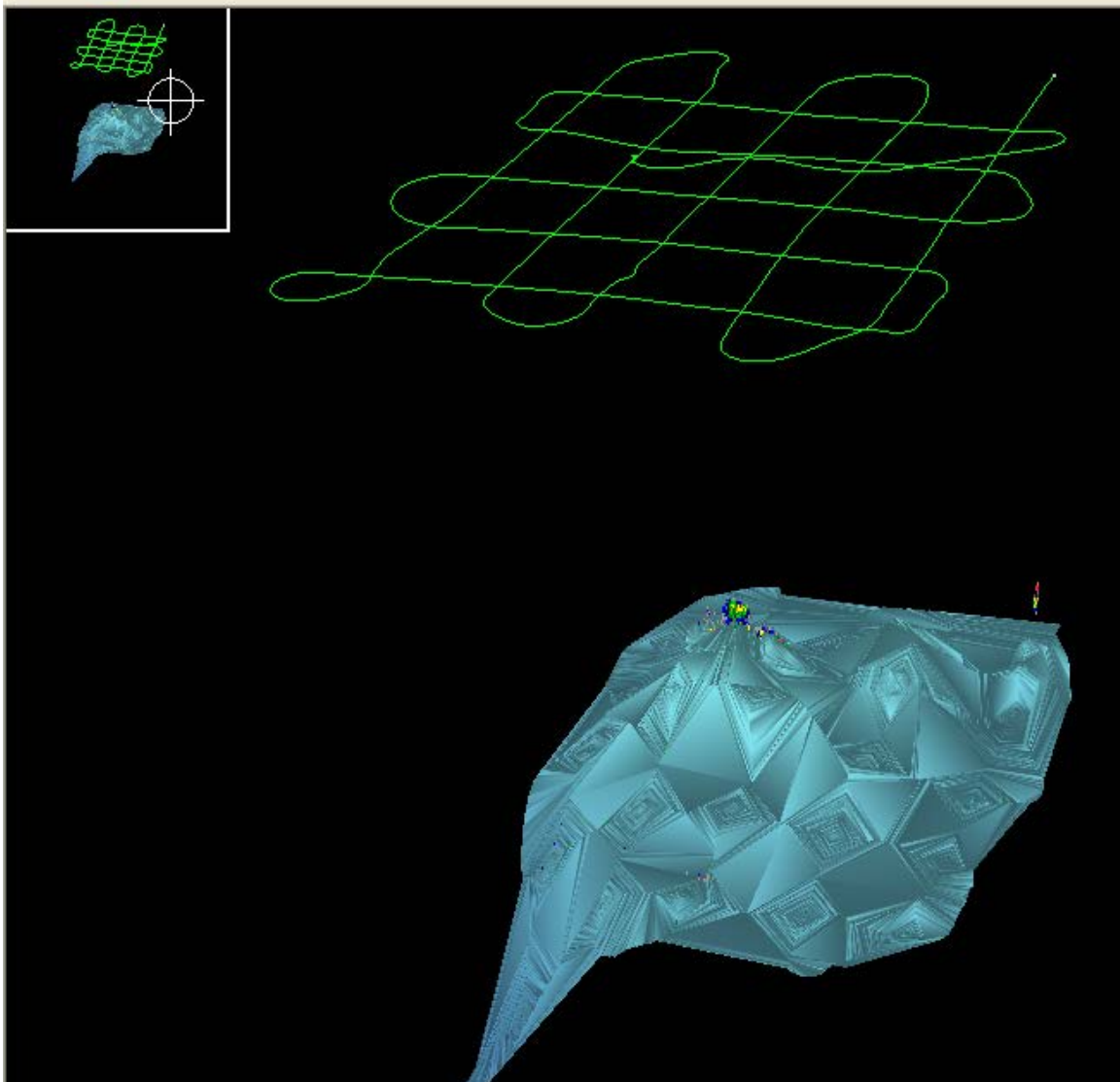

Figure 1.51. Kidney Bank (190304) distribution of s_A ($m^2/n.mi.^2$) attributed to rockfishes.

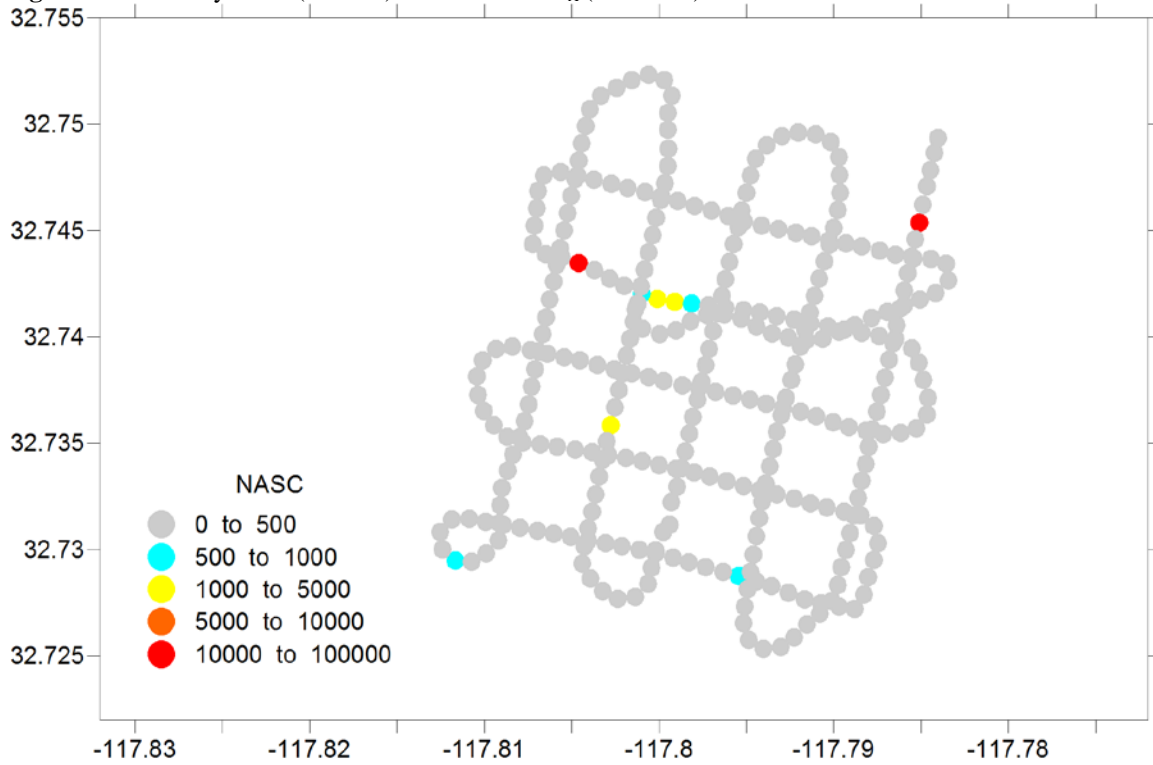

Figure 1.52. Kidney Bank (190304) area backscatter coefficients ($s_a; m^2/m^2$) attributed to seabed type.

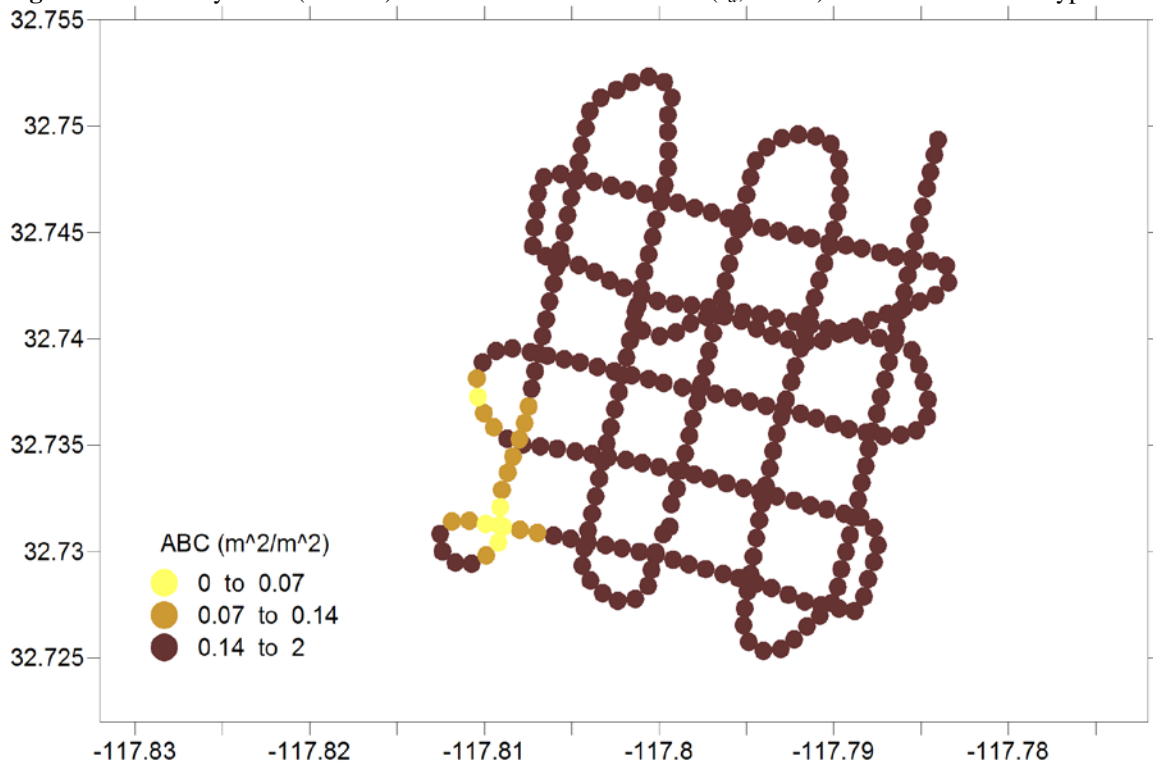

Figure 1.53. Forty-Three Fathom Bank Grid 2 (200304) 3-D image of bathymetry (m) and S_v of rockfishes (dB).

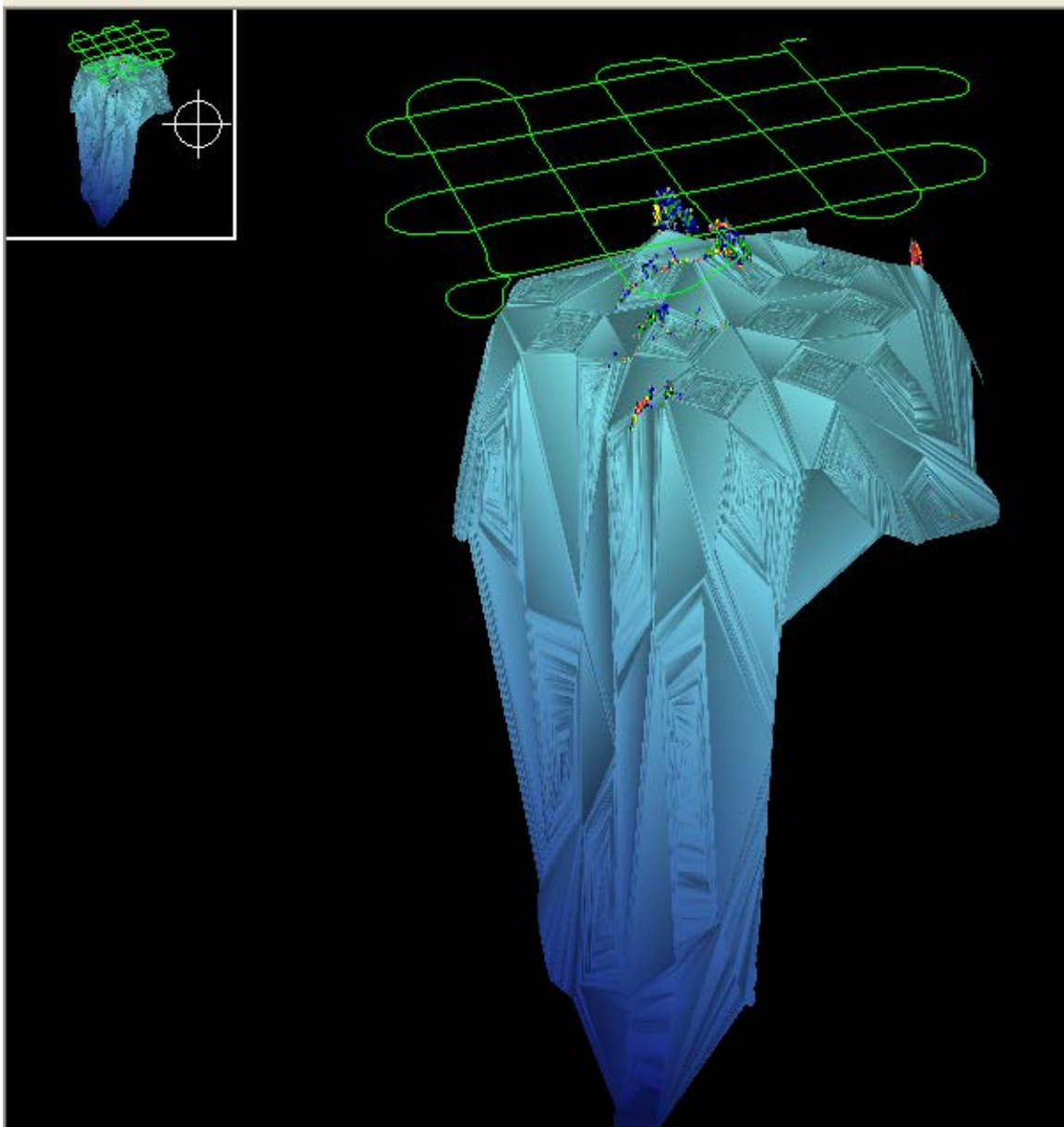

Figure 1.54. Forty-Three Fathom Bank Grid 2 (200304) distribution of s_A ($m^2/n.mi.^2$) attributed to rockfishes.

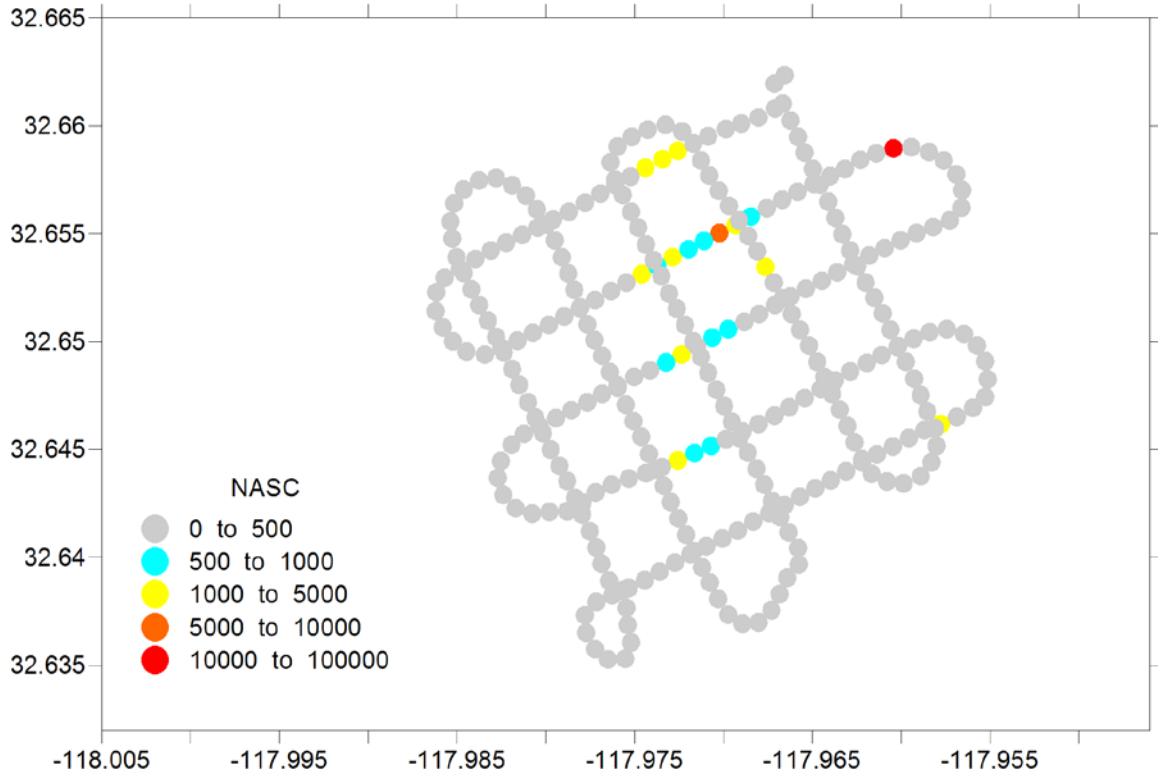

Figure 1.55. Forty-Three Fathom Bank Grid 2 (200304) area backscatter coefficients (s_a ; m^2/m^2) attributed to seabed type.

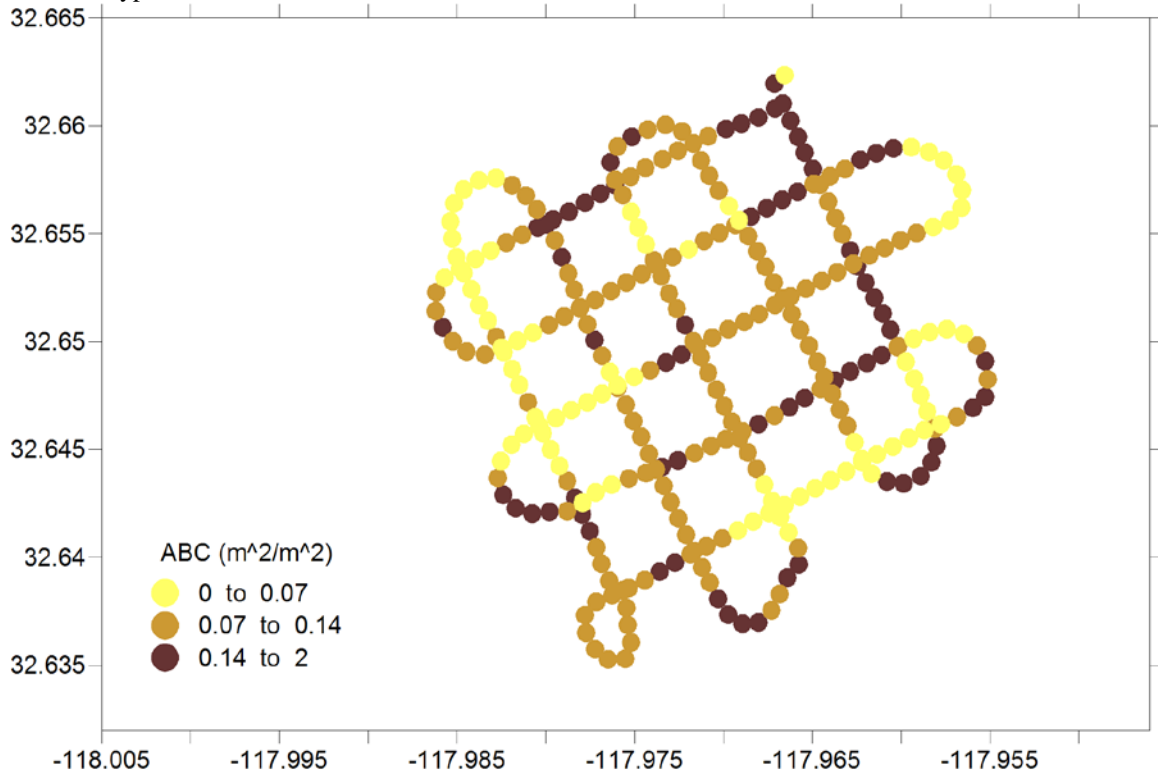

Figure 1.56. Potato Bank (200304) 3-D image of bathymetry (m) and S_v of rockfishes (dB).
[View westwards].

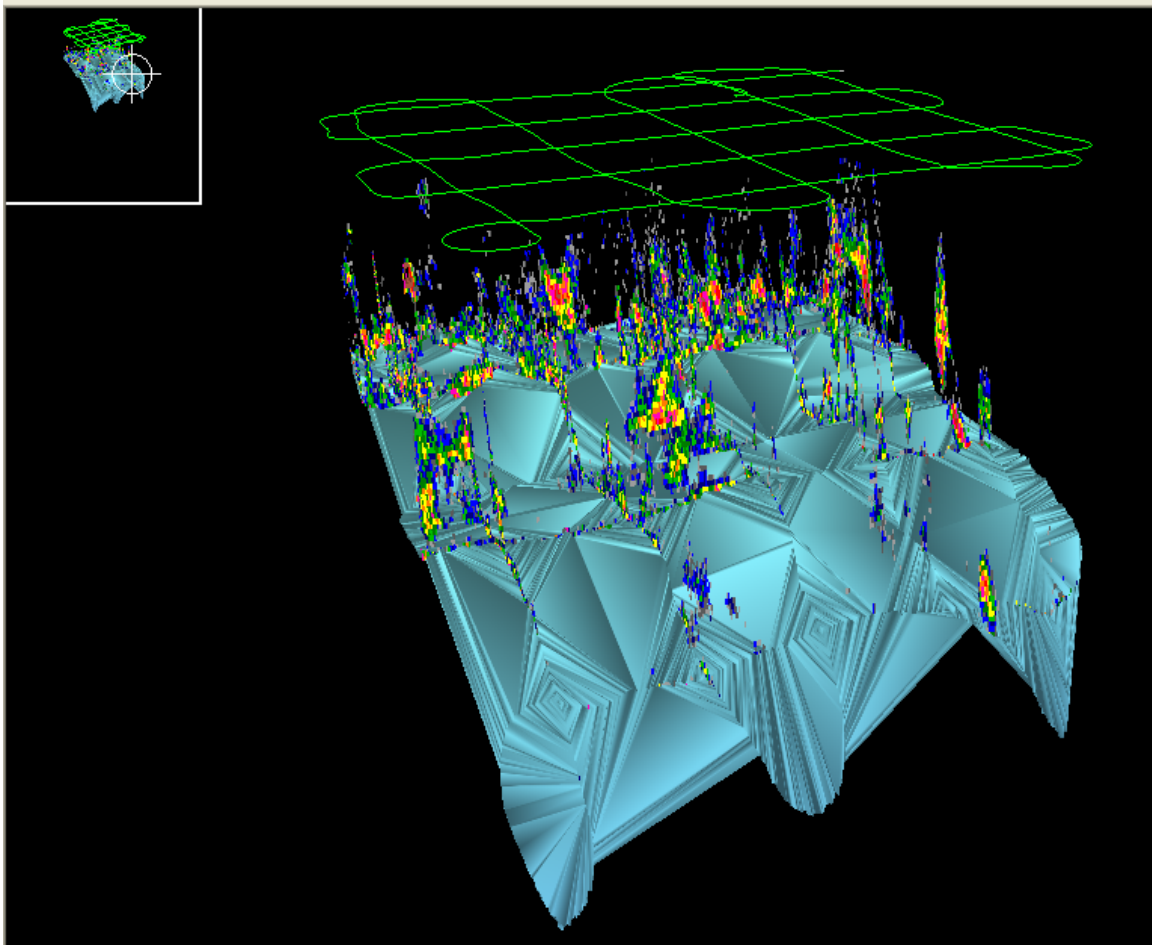

Figure 1.57. Potato Bank (200304) distribution of s_A ($m^2/n.mi.^2$) attributed to rockfishes.

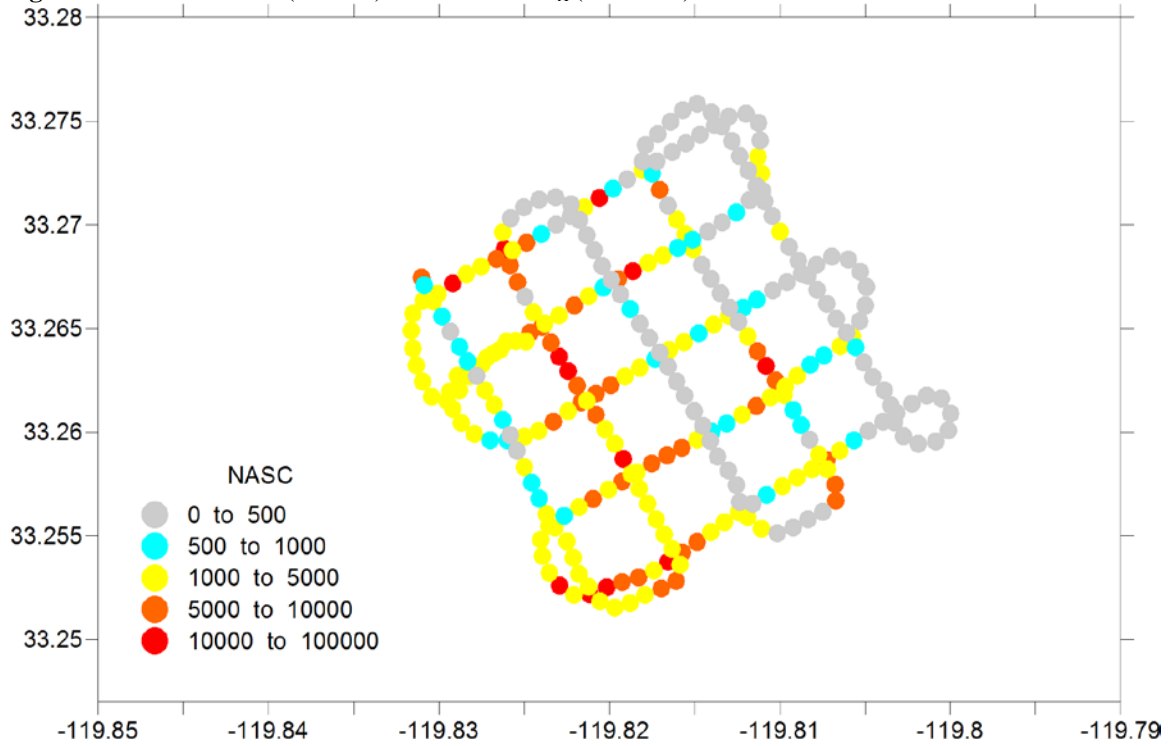

Figure 1.58. Potato Bank (200304) area backscatter coefficients (s_a ; m^2/m^2) attributed to seabed type.

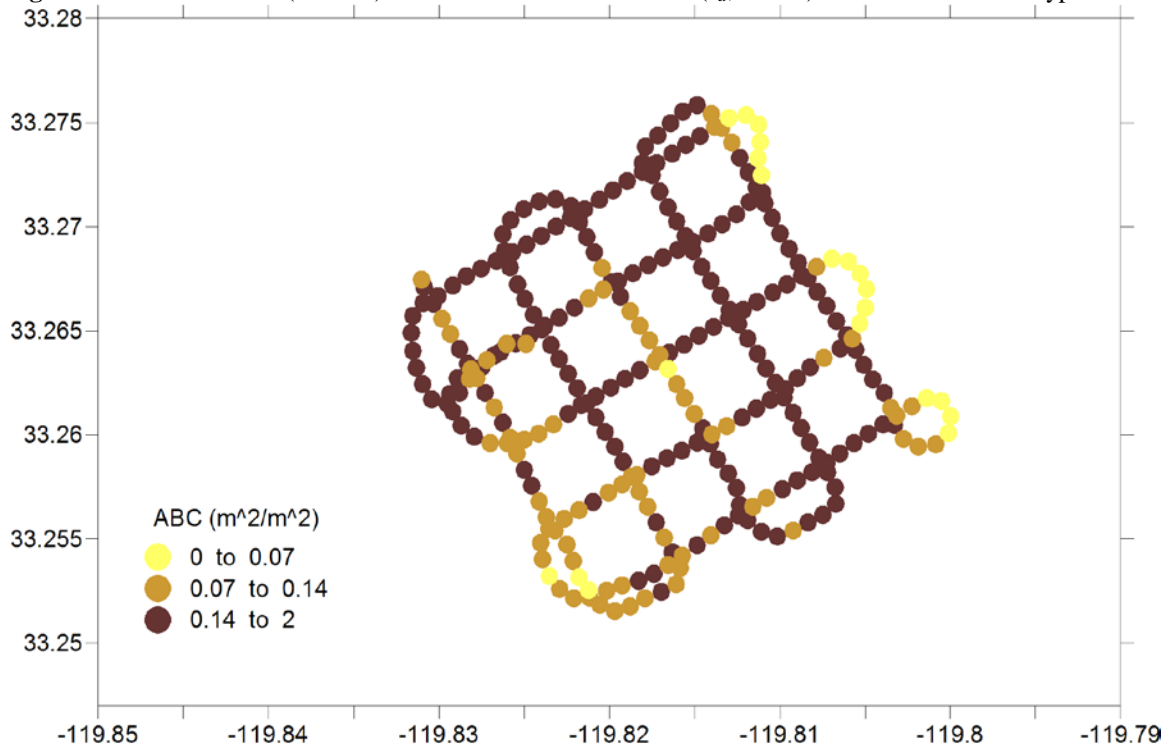

Figure 1.59. San Nicolas Island (210304) 3-D image of bathymetry (m) and S_v of rockfishes (dB).

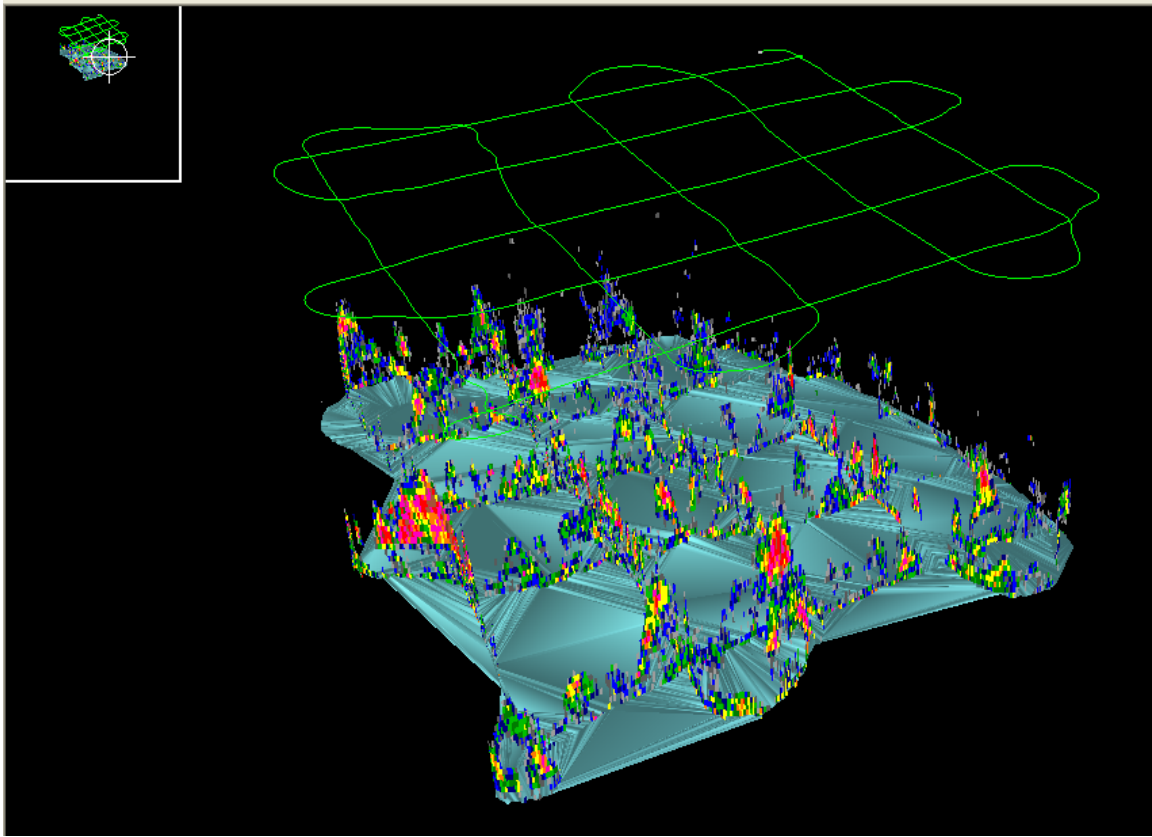

Figure 1.60. San Nicolas Island (210304) distribution of s_A ($m^2/n.mi.^2$) attributed to rockfishes.

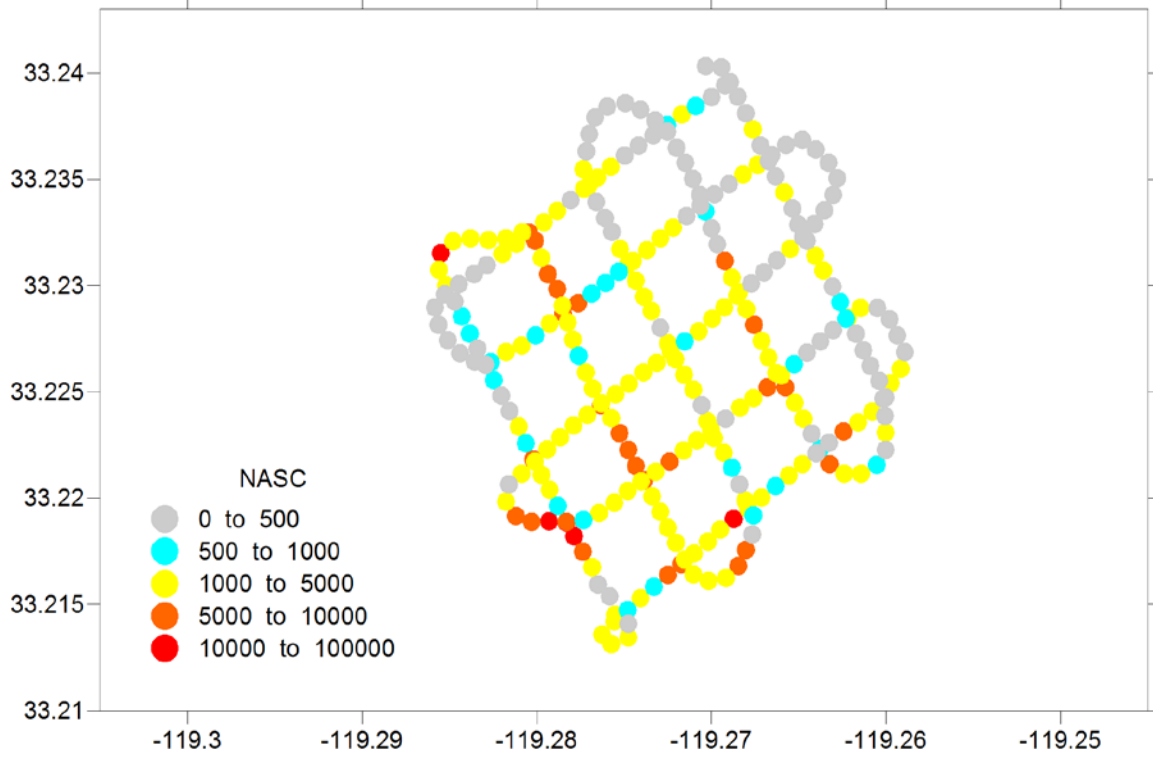

Figure 1.61. San Nicolas Island (210304) area backscatter coefficients (s_a ; m^2/m^2) attributed to seabed type.

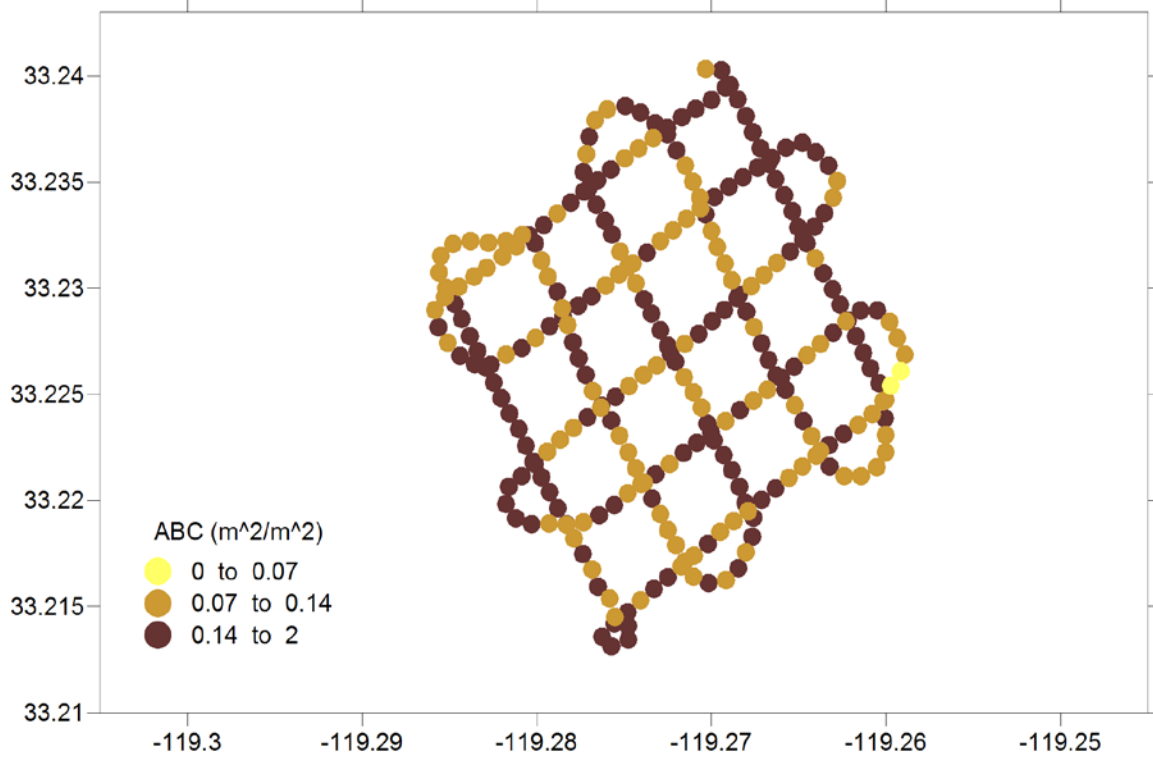

Figure 1.62. Osborne Bank (210304) 3-D image of bathymetry (m) and S_v of rockfishes (dB).

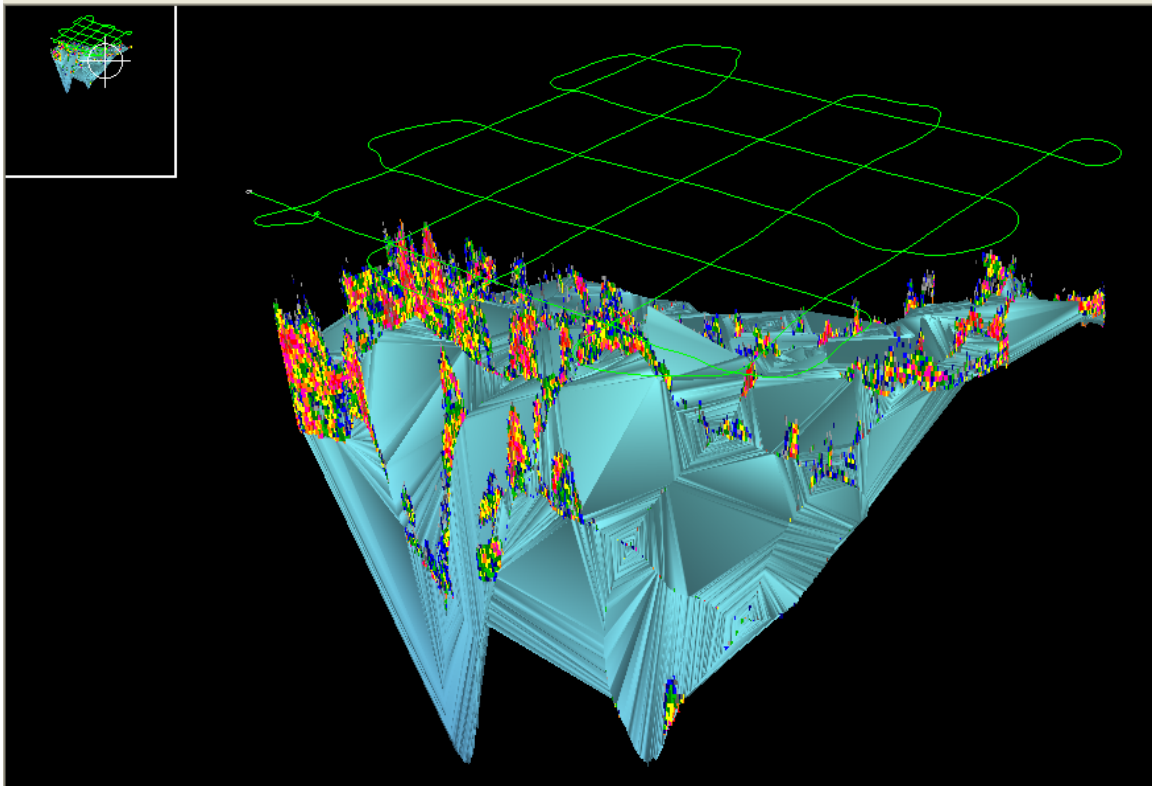

Figure 1.63. Osborne Bank (210304) distribution of s_A ($m^2/n.mi.^2$) attributed to rockfishes.

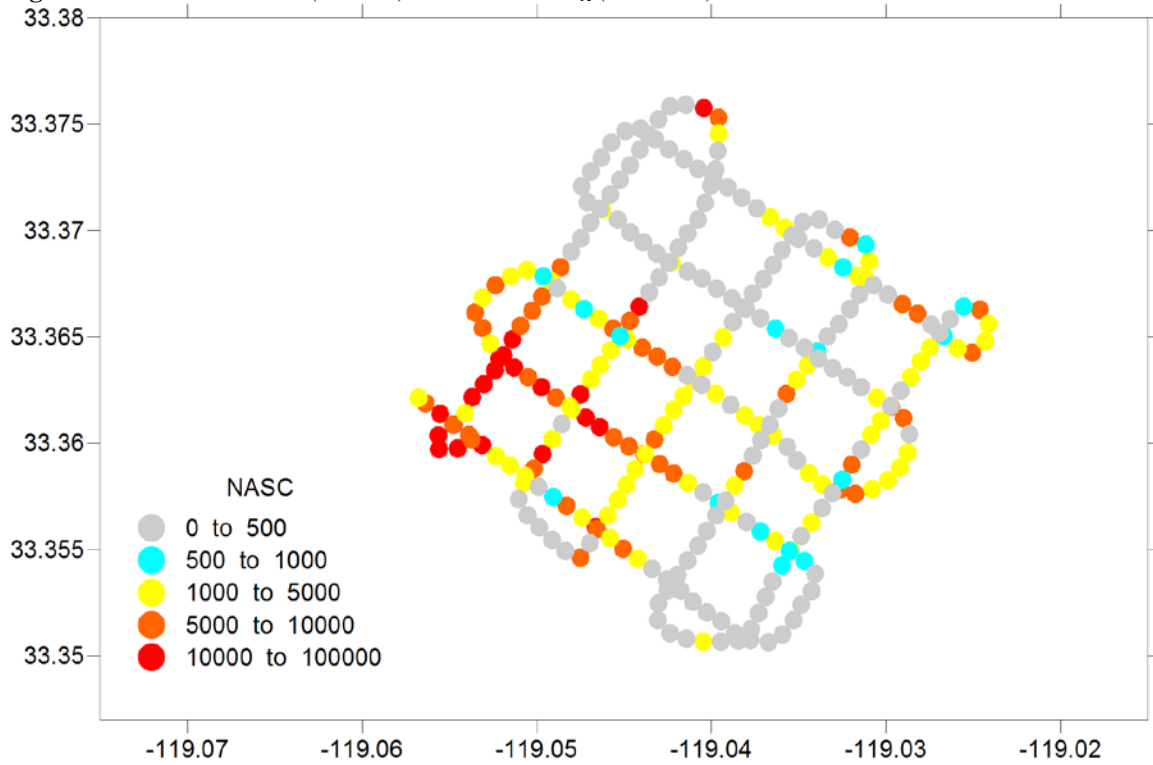
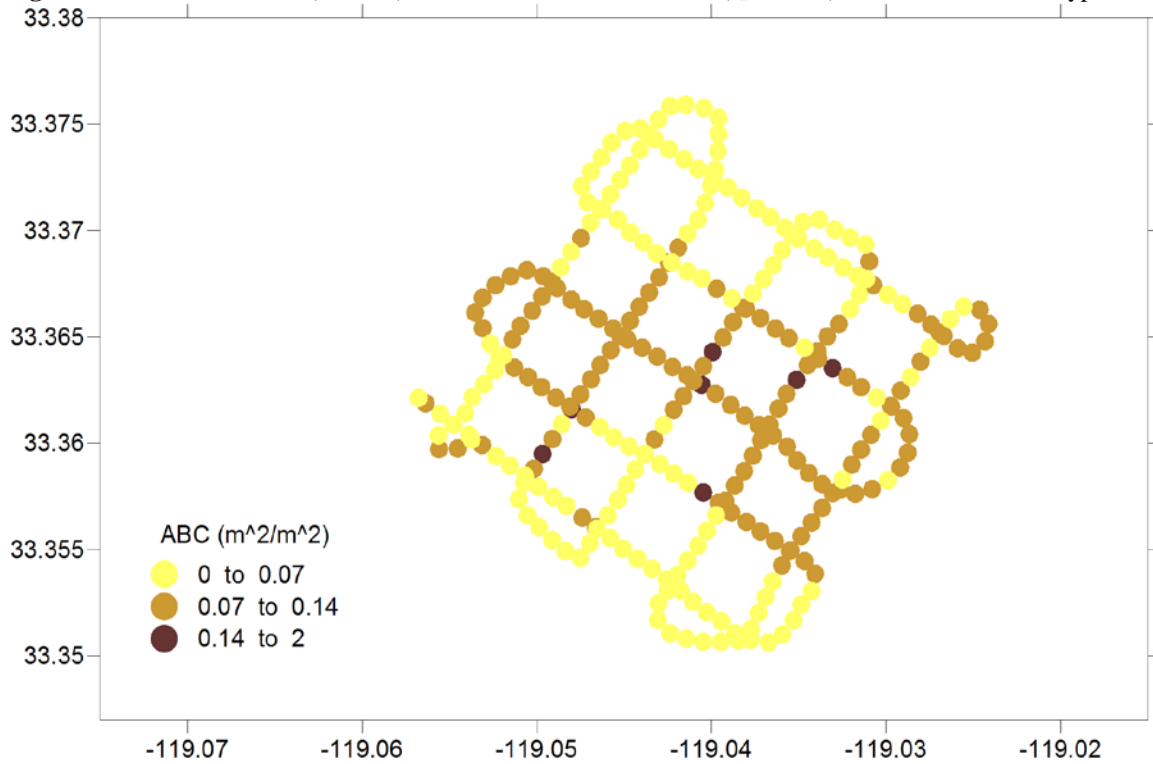

Figure 1.64. Osborne Bank (210304) area backscatter coefficients (s_a ; m^2/m^2) attributed to seabed type.



Cruise Leg 8

Forty-Three Fathom Bank: Three survey grids were performed in comparable areas of the bank but at different times of the day. The first survey was during nighttime (0052 to 0429 PST) and very few fish were observed acoustically (**Figs. 1.65, 1.66** and **1.67**). In contrast, the survey during dawn (0440 to 0816 PST) and mid morning (1032 to 1318 PST) mapped dense aggregations of fish, particularly in the shallowest, central portion of the bank (e.g., **Figs. 1.68, 1.69** and **1.70**). During the morning survey, a few small fish aggregations were also mapped along the bank slopes (**Figs. 1.71, 1.72** and **1.73**).

Lasuen Knoll: This area was surveyed twice: during early morning (0624 to 0832 PST); and in the afternoon (1331 to 1539 PST). Both surveys mapped high densities of fish near the shallowest peaks in the southwestern portion of the bank (**Figs. 1.74, 1.75, 1.76, 1.77, 1.78** and **1.79**). Some of these schools appear to be pelagic and move some between the two surveys.

San Nicolas Island: Again, high densities of fish were ubiquitous in this area (**Figs. 1.80, 1.81** and **1.82**). Again, the highest fish densities were located in the southwestern portion of the area.

Figure 1.65. Forty-Three Fathom Bank Grid 1 (020404) 3-D image of bathymetry (m) and S_v of rockfishes (dB).

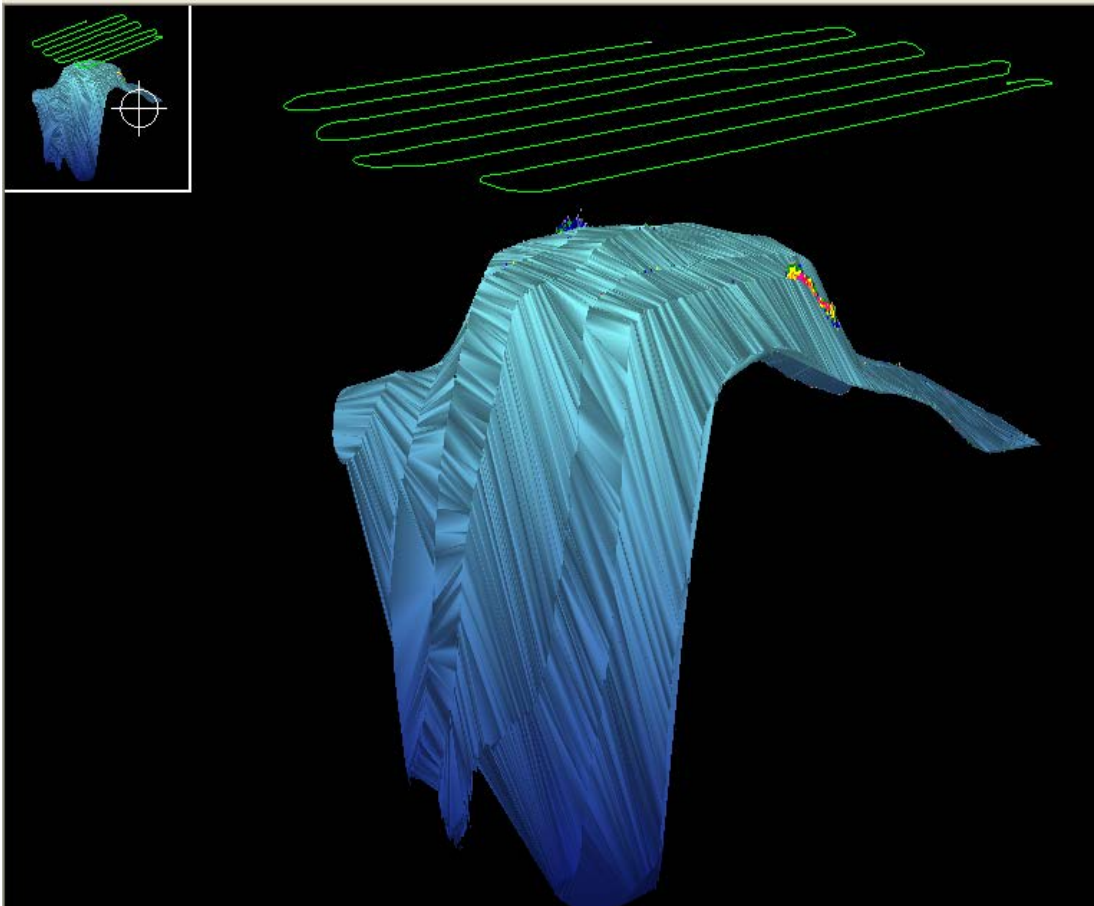

Figure 1.66. Forty-Three Fathom Bank Grid 1 (020404) distribution of s_A ($m^2/n.mi.^2$) attributed to rockfishes.

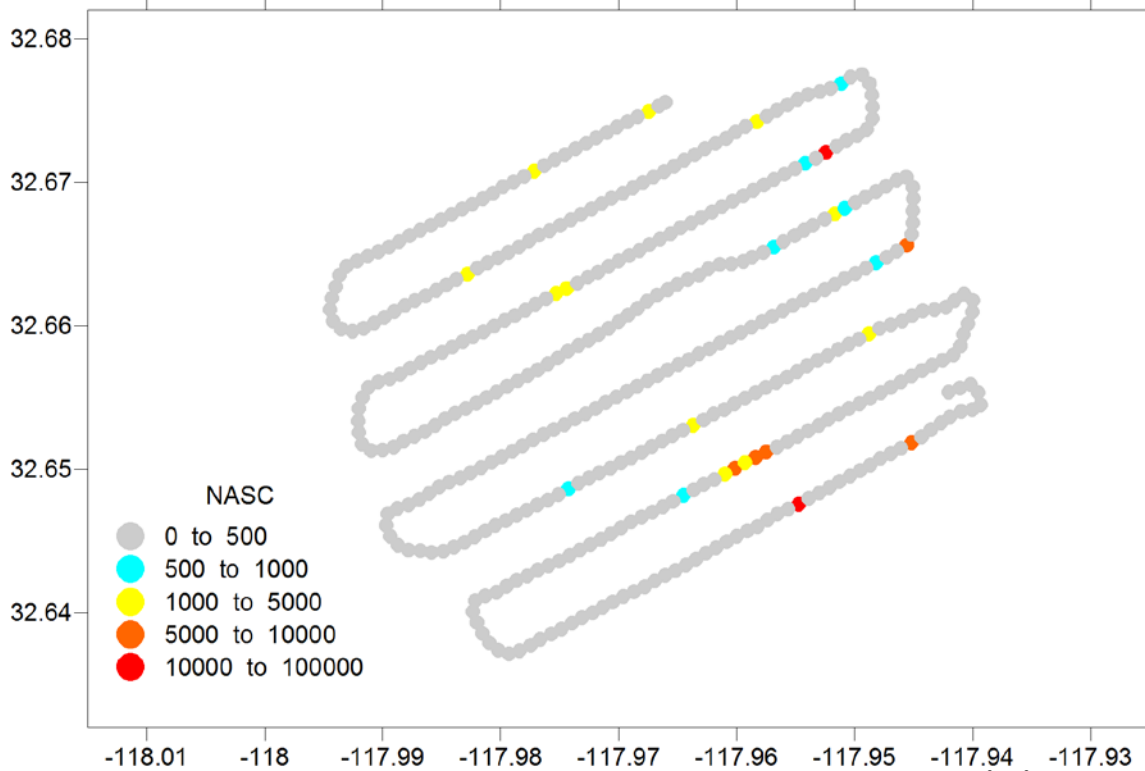

Figure 1.67. Forty-Three Fathom Bank Grid 1 (020404) area backscatter coefficients (s_a ; m^2/m^2) attributed to seabed type.

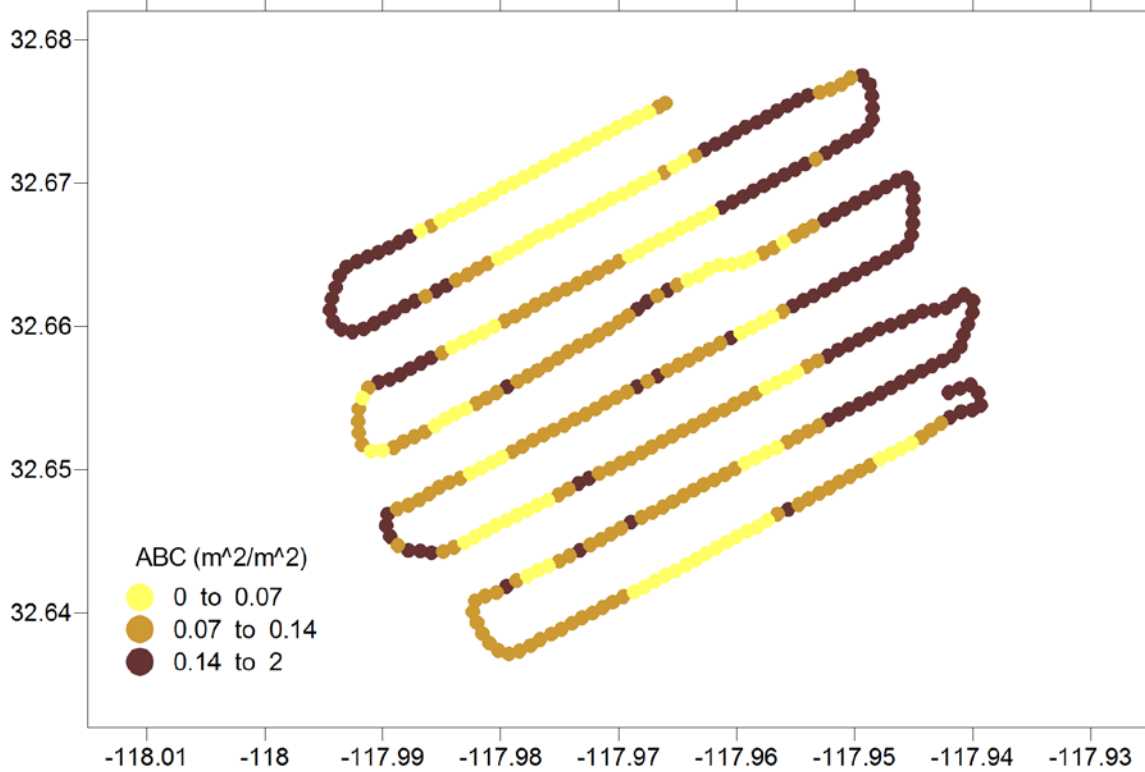

Figure 1.68. Forty-Three Fathom Bank Grid 2 (020404) 3-D image of bathymetry (m) and S_v of rockfishes (dB).

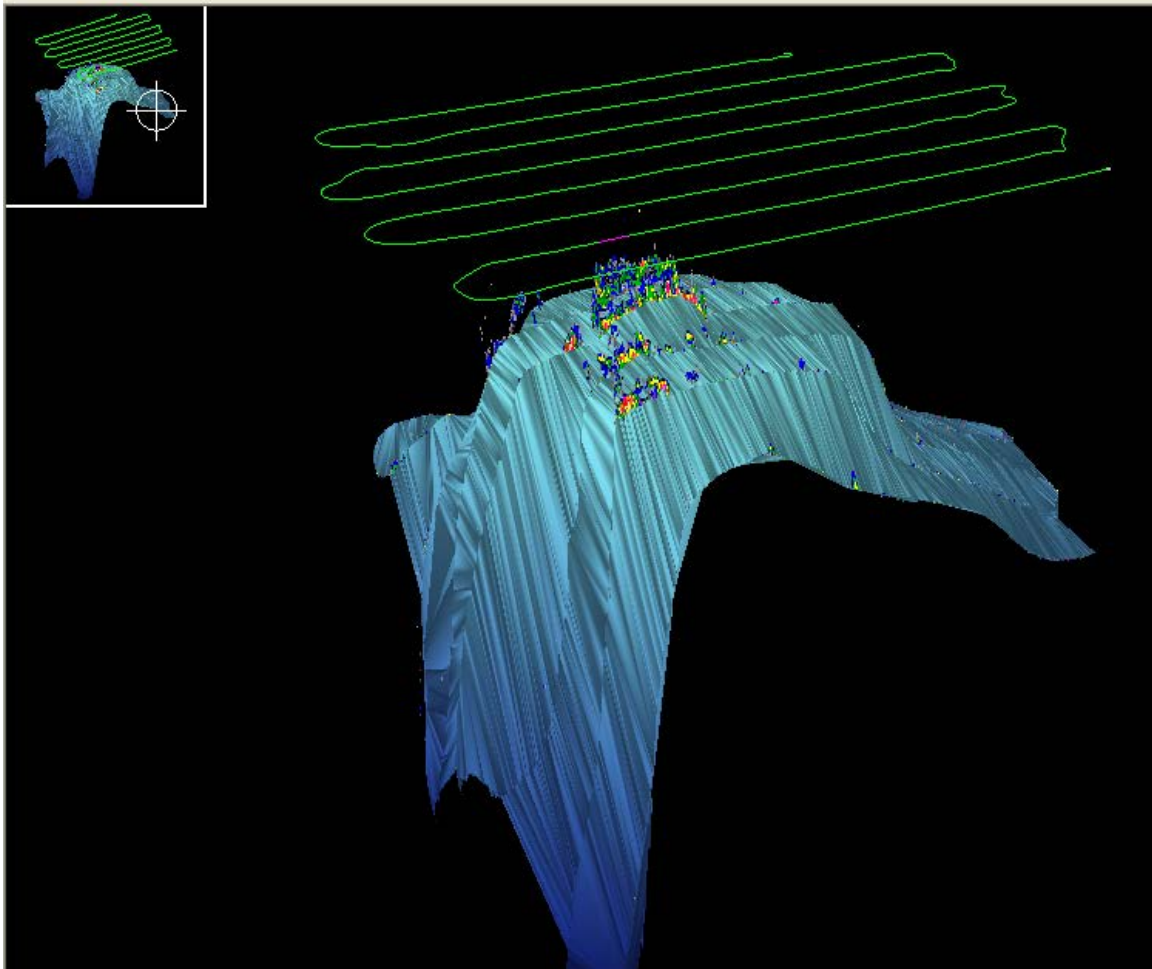

Figure 1.69. Forty-Three Fathom Bank Grid 2 (020404) distribution of s_A ($m^2/n.mi.^2$) attributed to rockfishes.

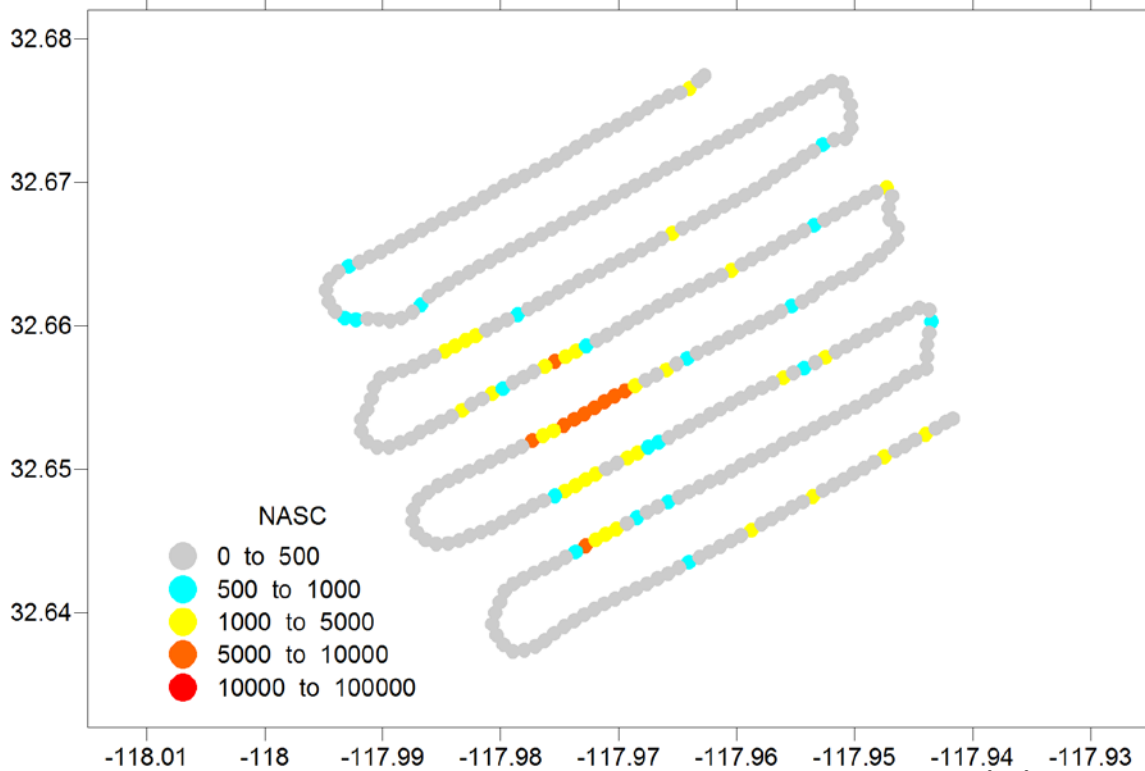

Figure 1.70. Forty-Three Fathom Bank Grid 2 (020404) area backscatter coefficients (s_a ; m^2/m^2) attributed to seabed type.

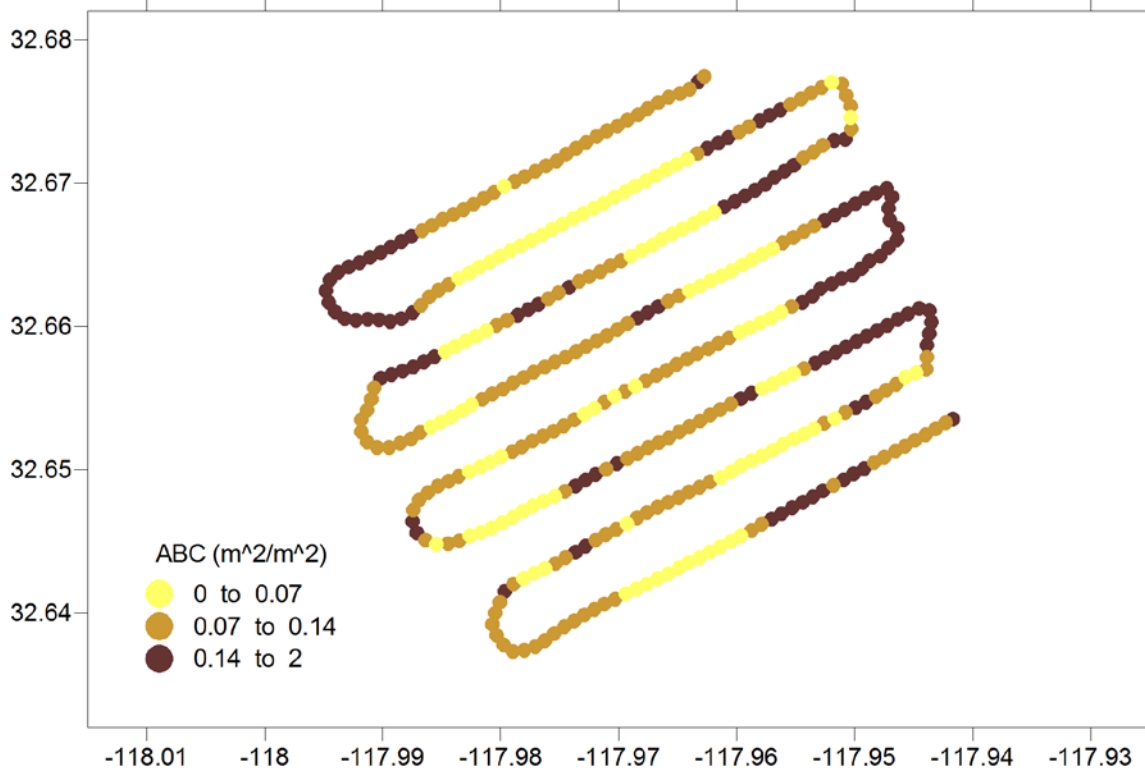

Figure 1.71. Forty-Three Fathom Bank Grid 3 (020404) 3-D image of bathymetry (m) and S_v of rockfishes (dB). [View southwards].

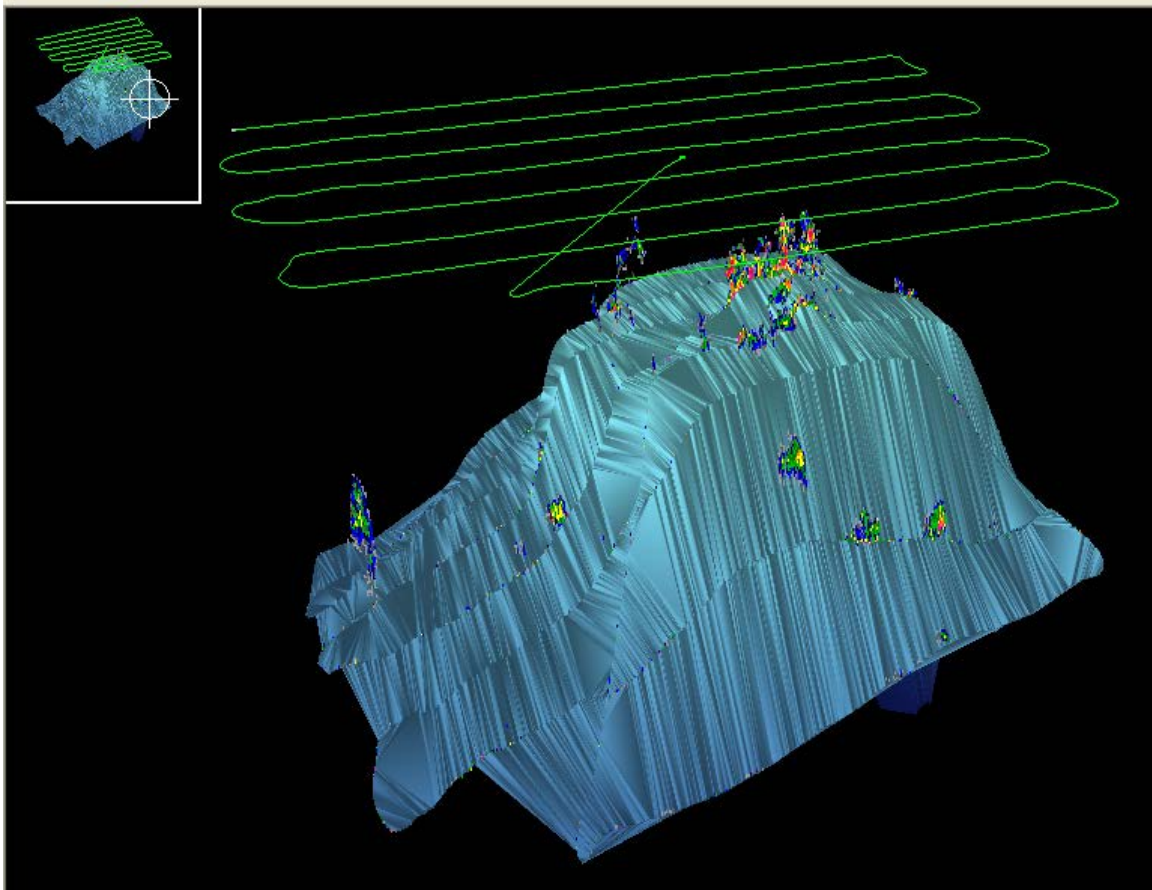

Figure 1.72. Forty-Three Fathom Bank Grid 3 (020404) distribution of s_A ($m^2/n.mi.^2$) attributed to rockfishes.

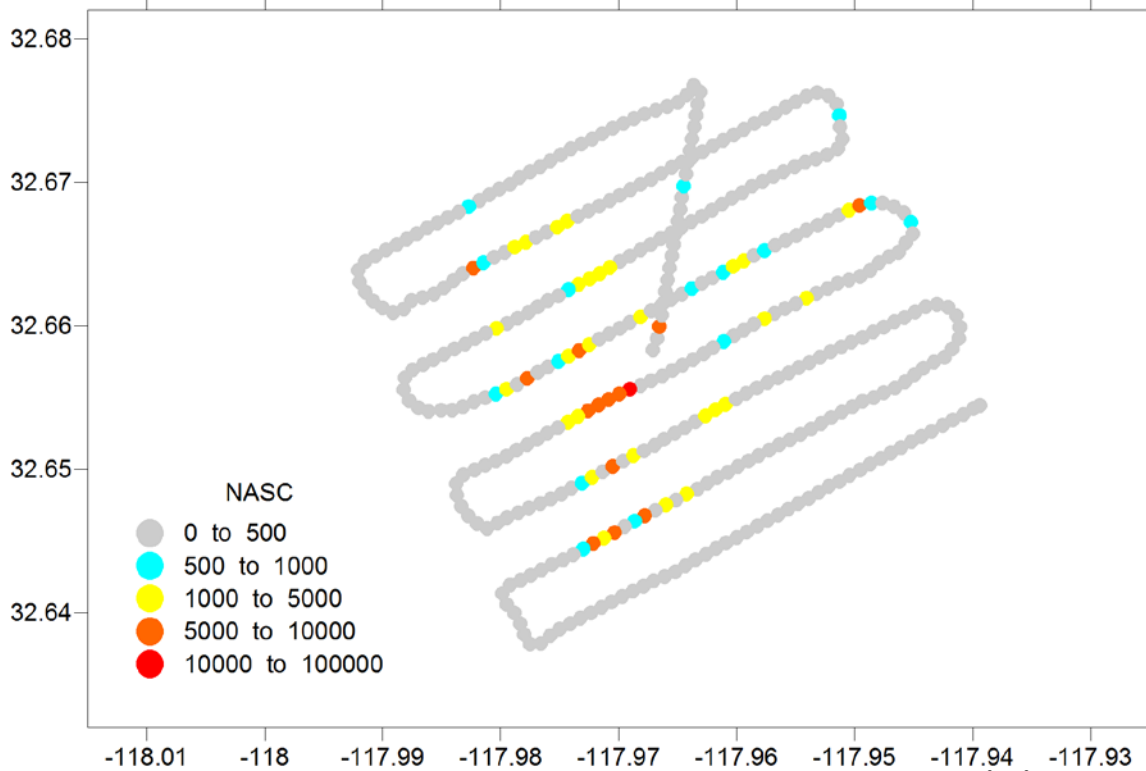

Figure 1.73. Forty-Three Fathom Bank Grid 3 (020404) area backscatter coefficients (s_a ; m^2/m^2) attributed to seabed type.

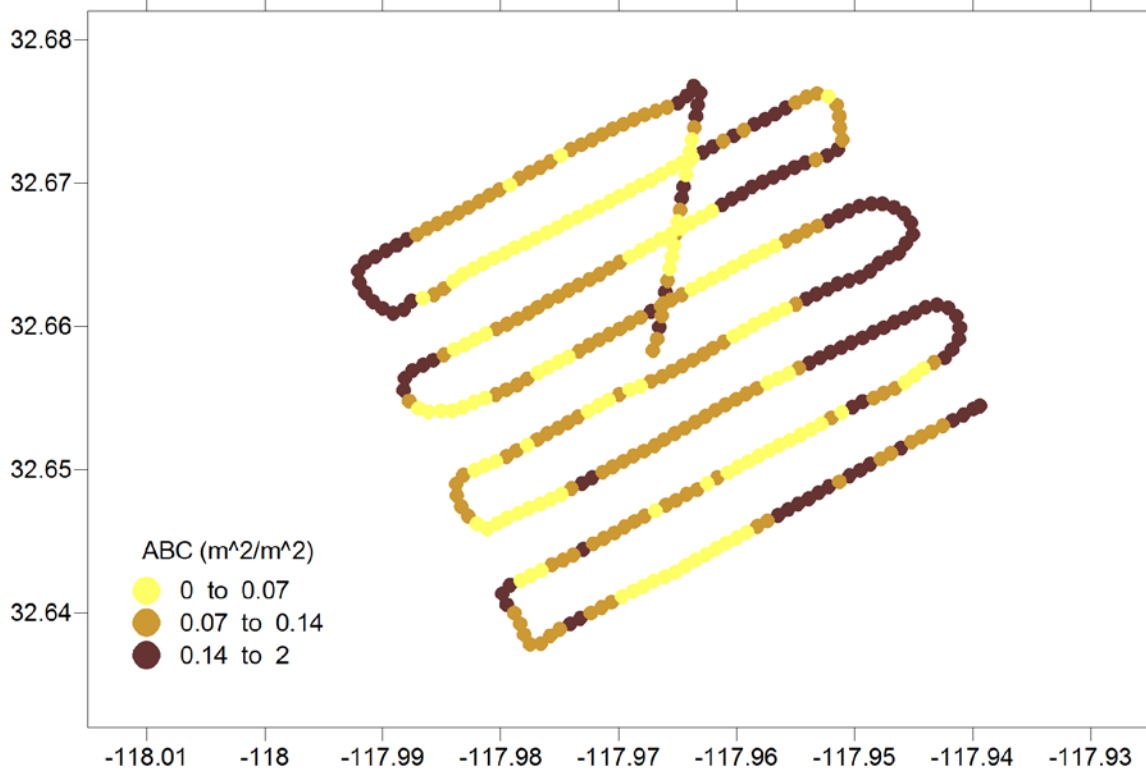

Figure 1.74. Lasuen Knoll Grid 1 (030404) 3-D image of bathymetry (m) and S_v of rockfishes (dB). [View westwards].

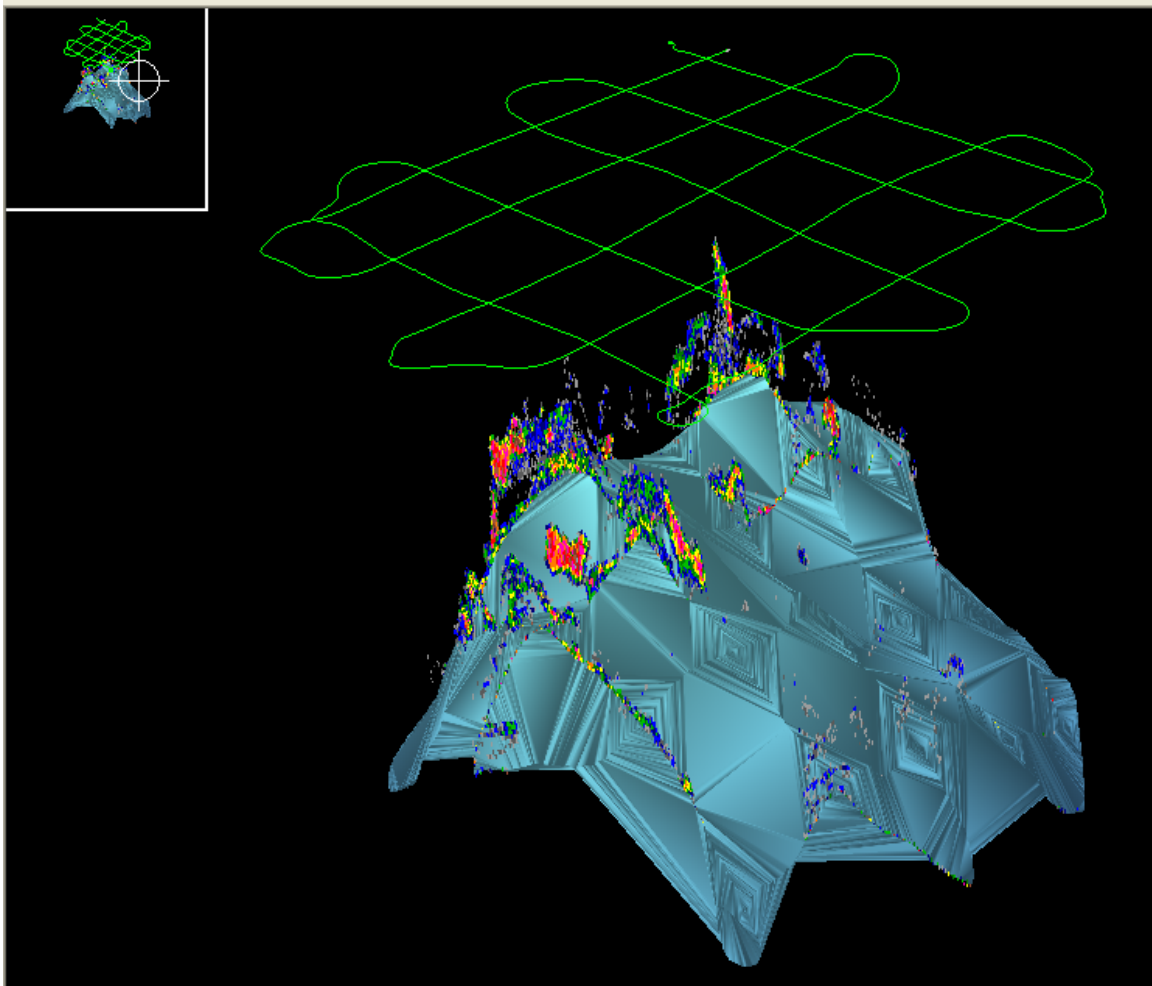

Figure 1.75. Lasuen Knoll Grid 1 (030404) distribution of s_A ($m^2/n.mi.^2$) attributed to rockfishes.

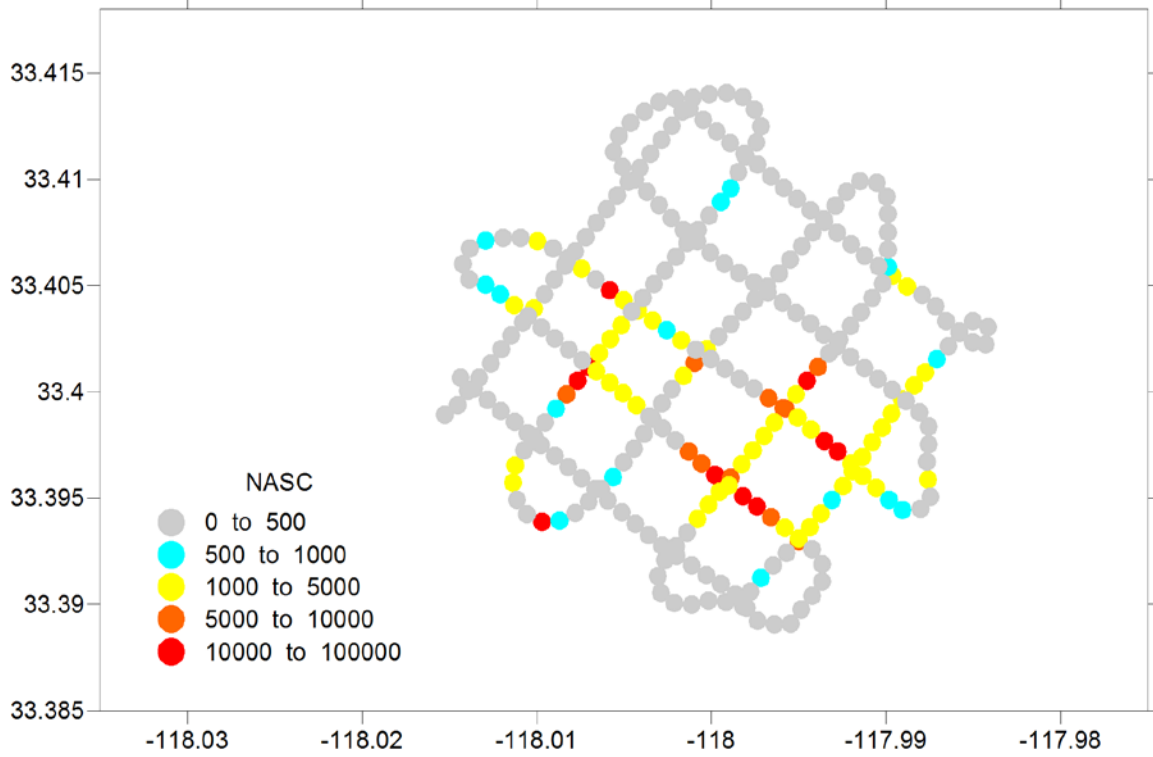

Figure 1.76. Lasuen Knoll Grid 1 (030404) area backscatter coefficients (s_a ; m^2/m^2) attributed to seabed type.

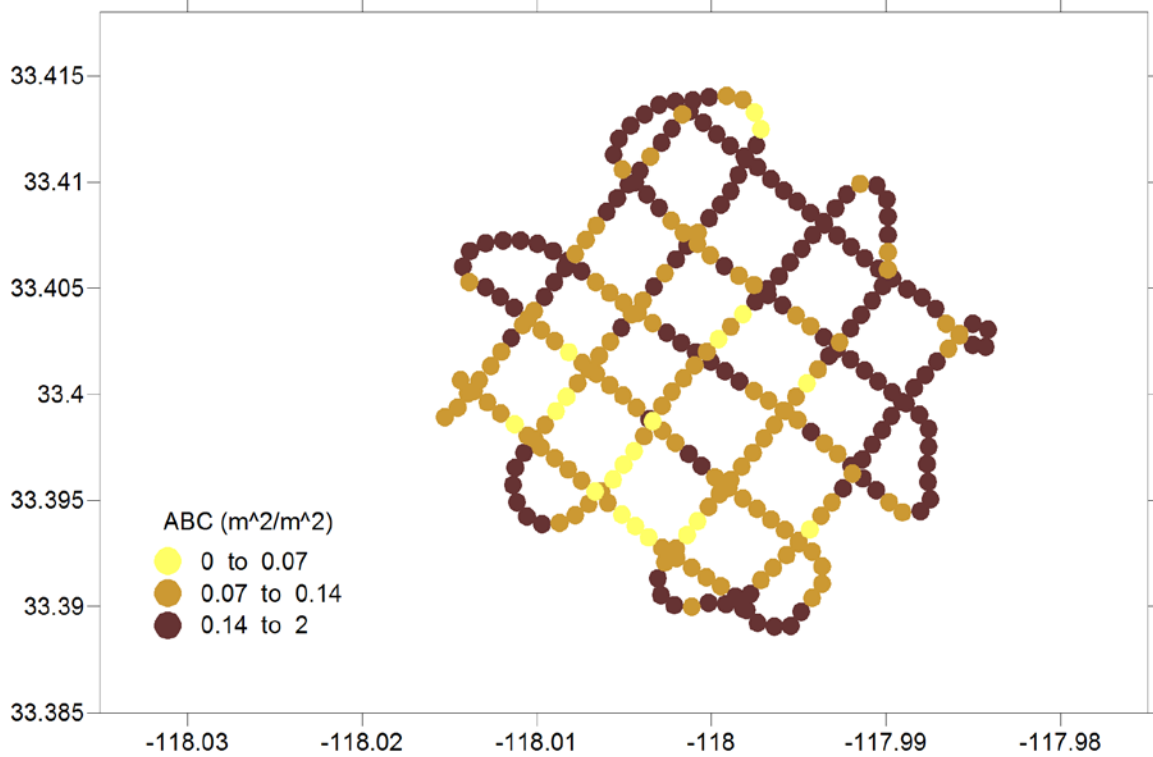

Figure 1.77. Lasuen Knoll Grid 2 (030404) 3-D image of bathymetry (m) and S_v of rockfishes (dB).

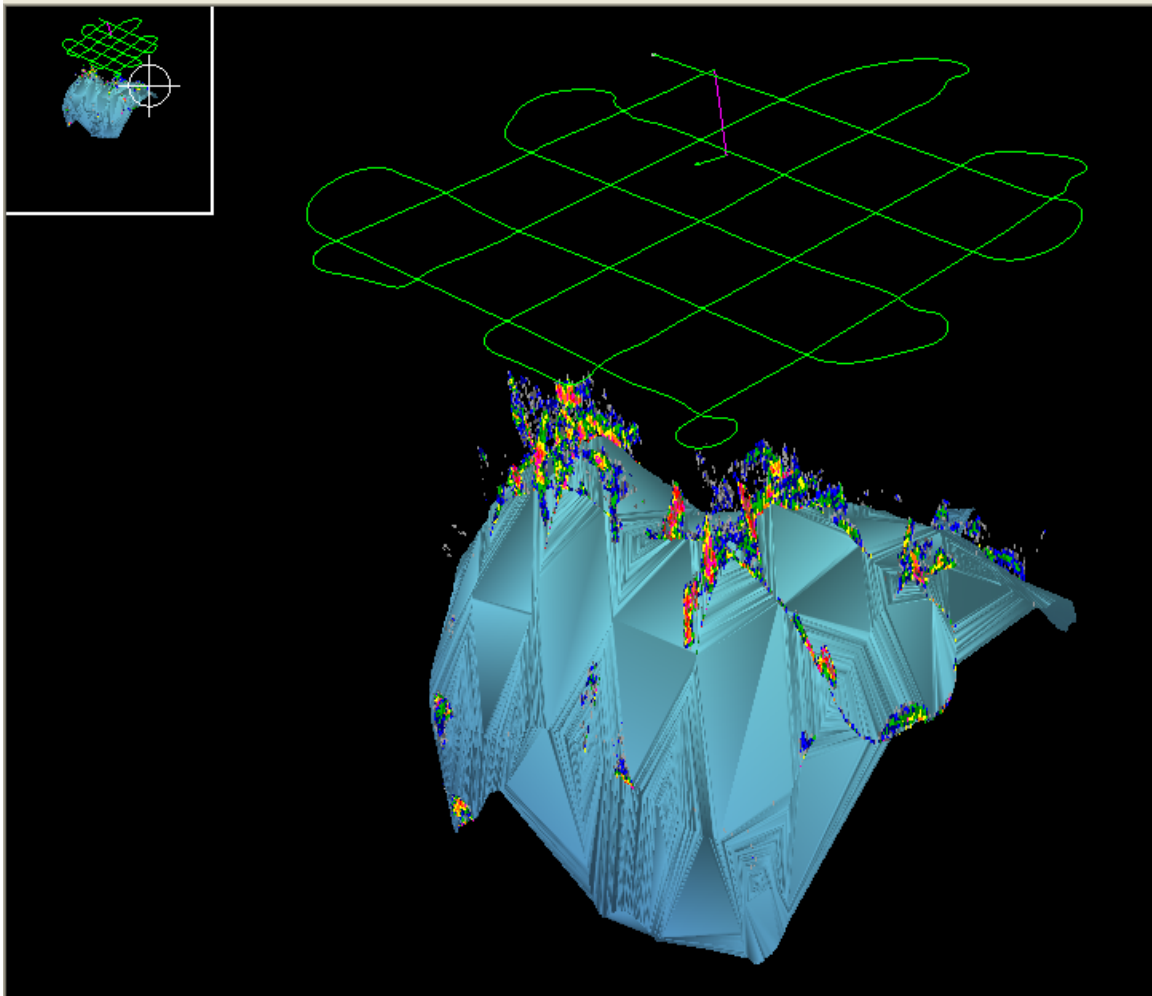

Figure 1.78. Lasuen Knoll Grid 2 (030404) distribution of s_A ($m^2/n.mi.^2$) attributed to rockfishes.

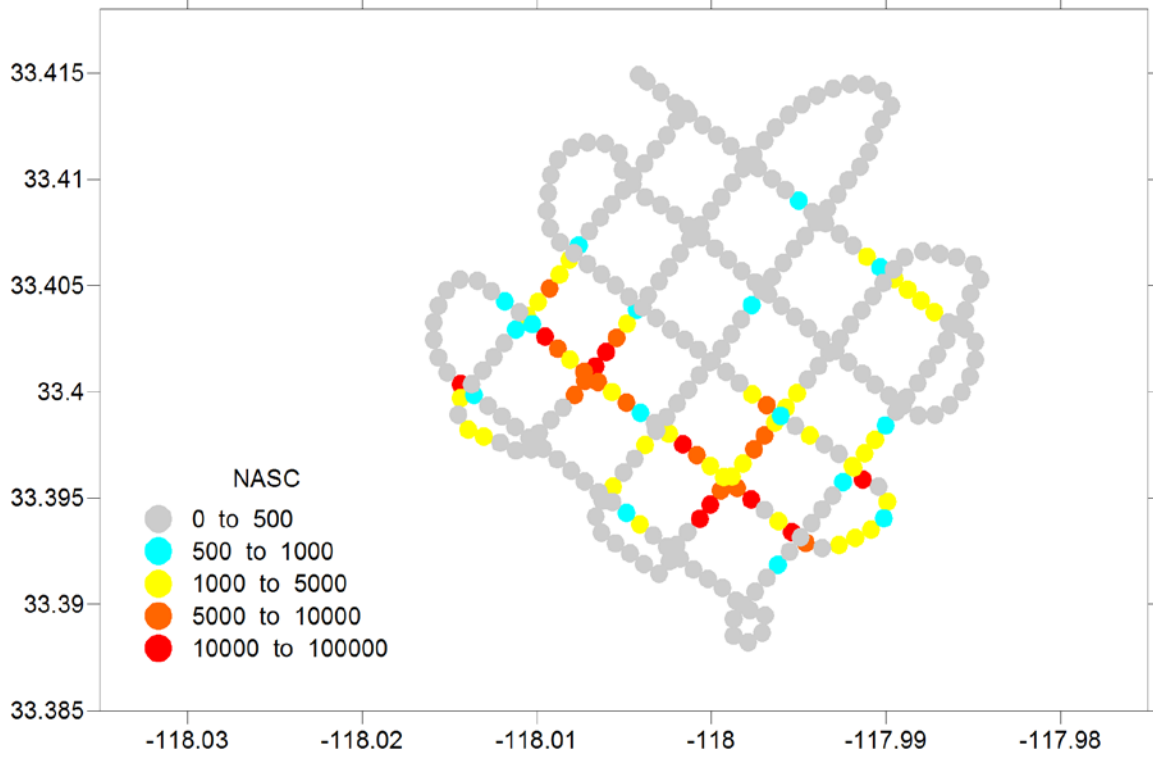

Figure 1.79. Lasuen Knoll Grid 2 (030404) area backscatter coefficients (s_a ; m^2/m^2) attributed to seabed type.

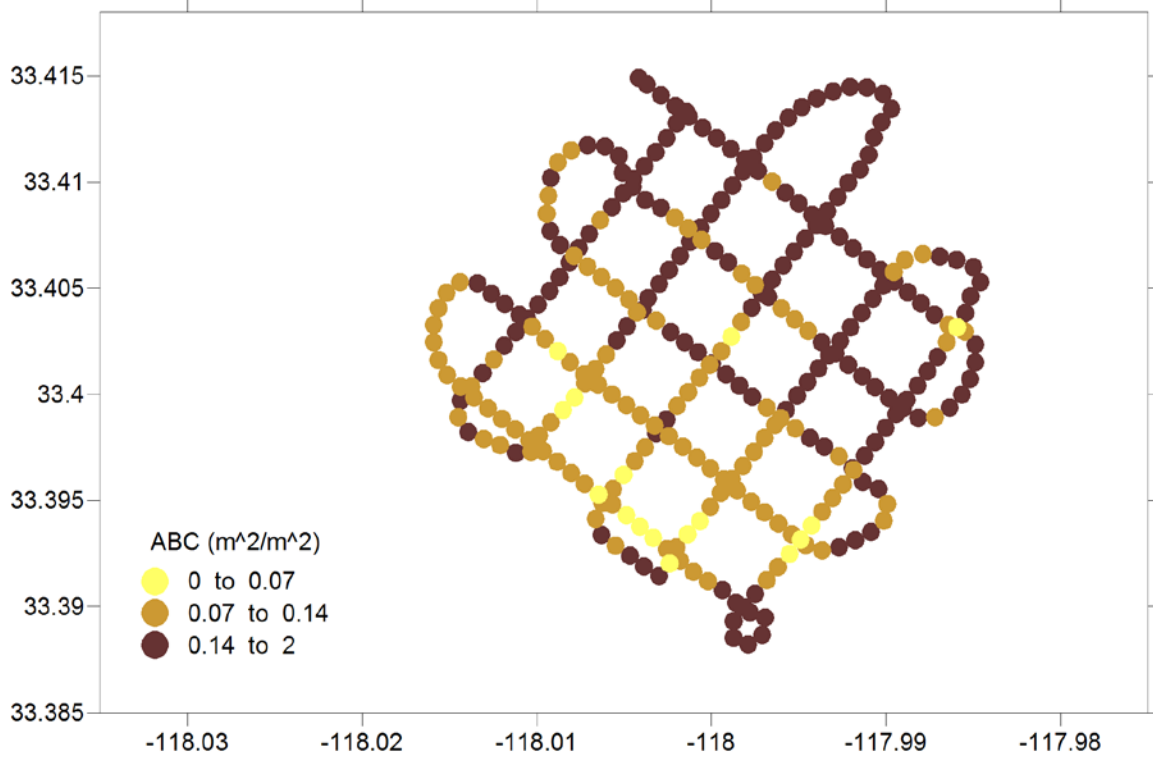

Figure 1.80. San Nicolas Island (040404) 3-D image of bathymetry (m) and S_v of rockfishes (dB).

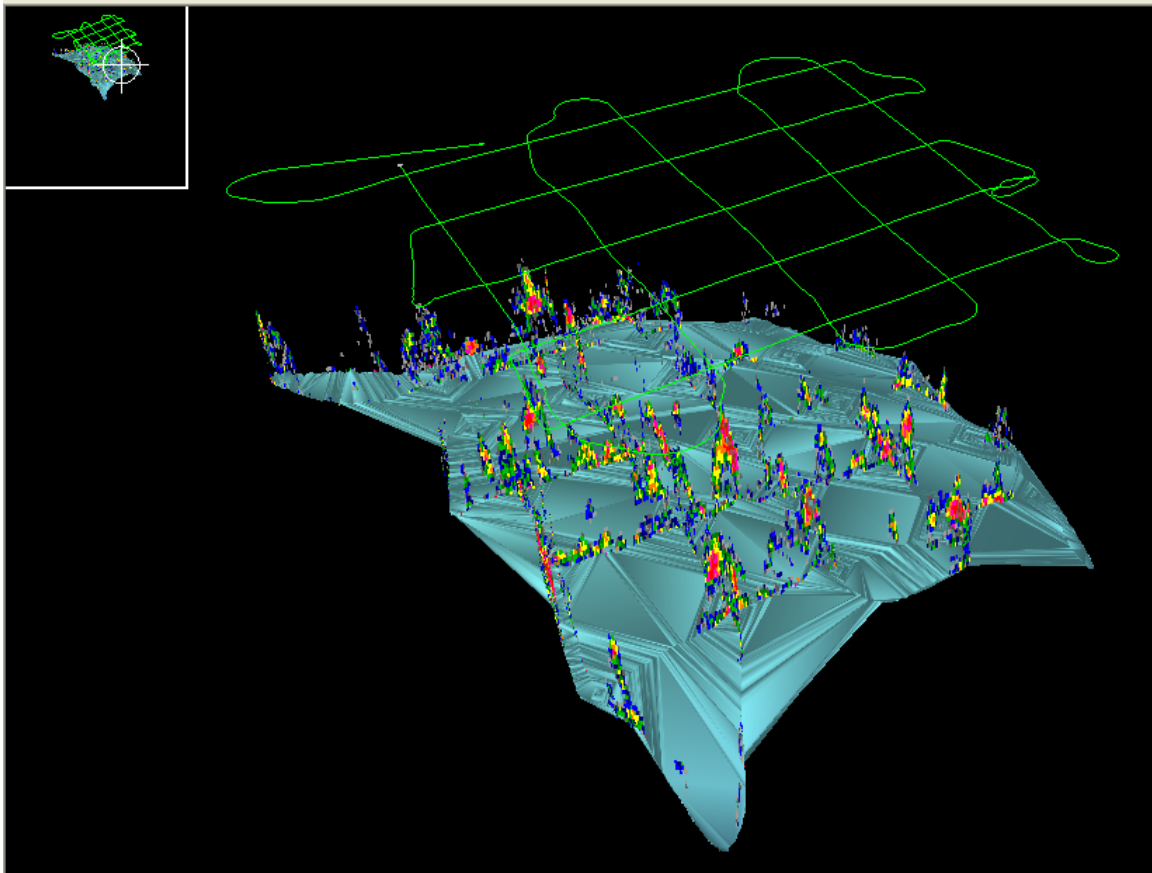

Figure 1.81. San Nicolas Island (040404) distribution of s_A ($m^2/n.mi.^2$) attributed to rockfishes.

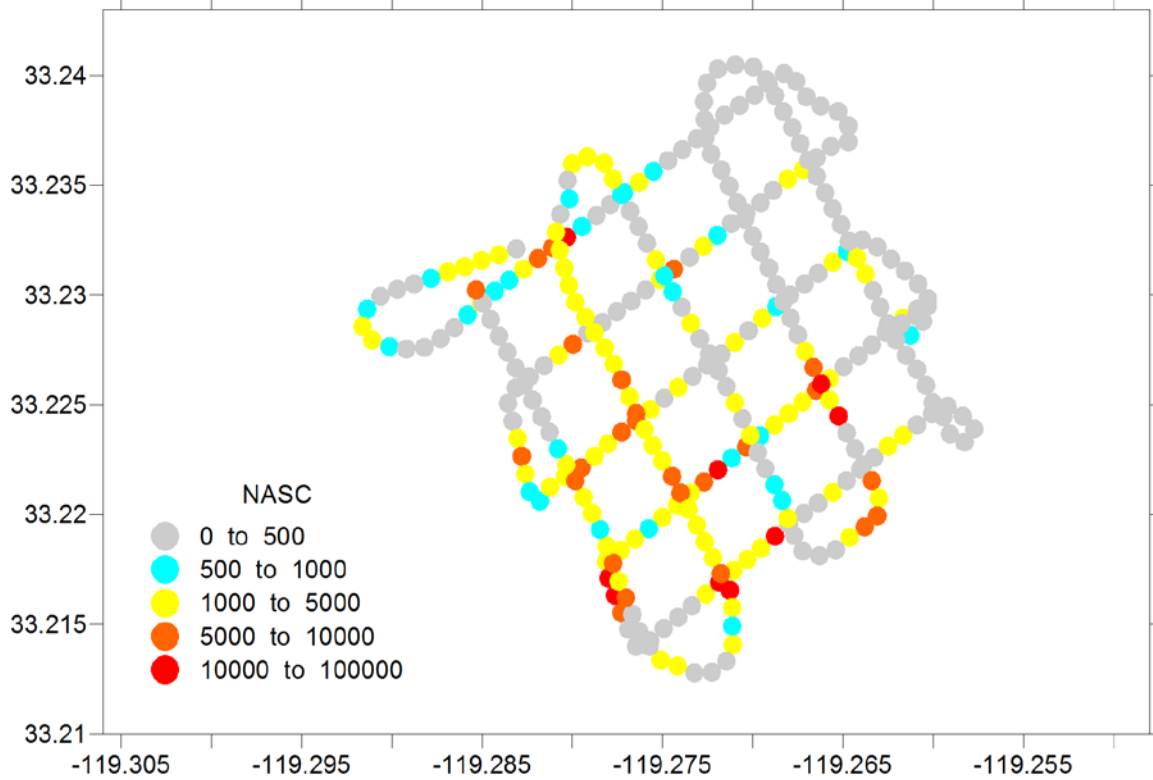
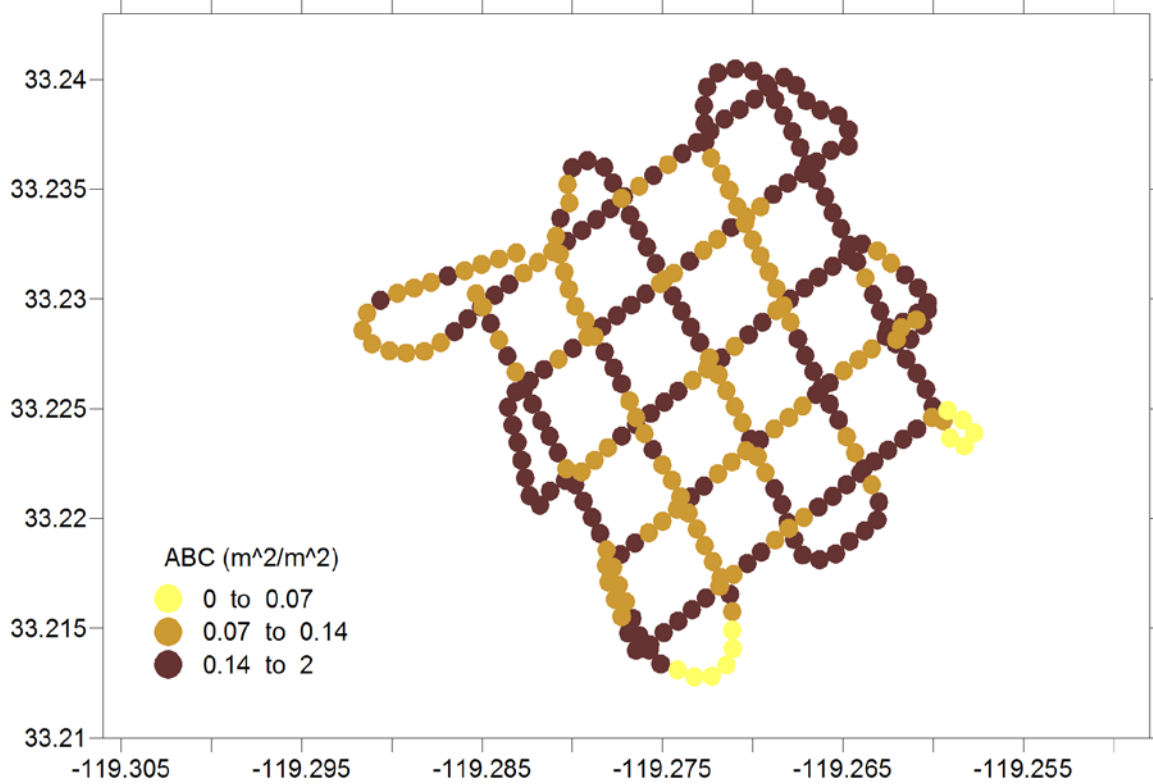
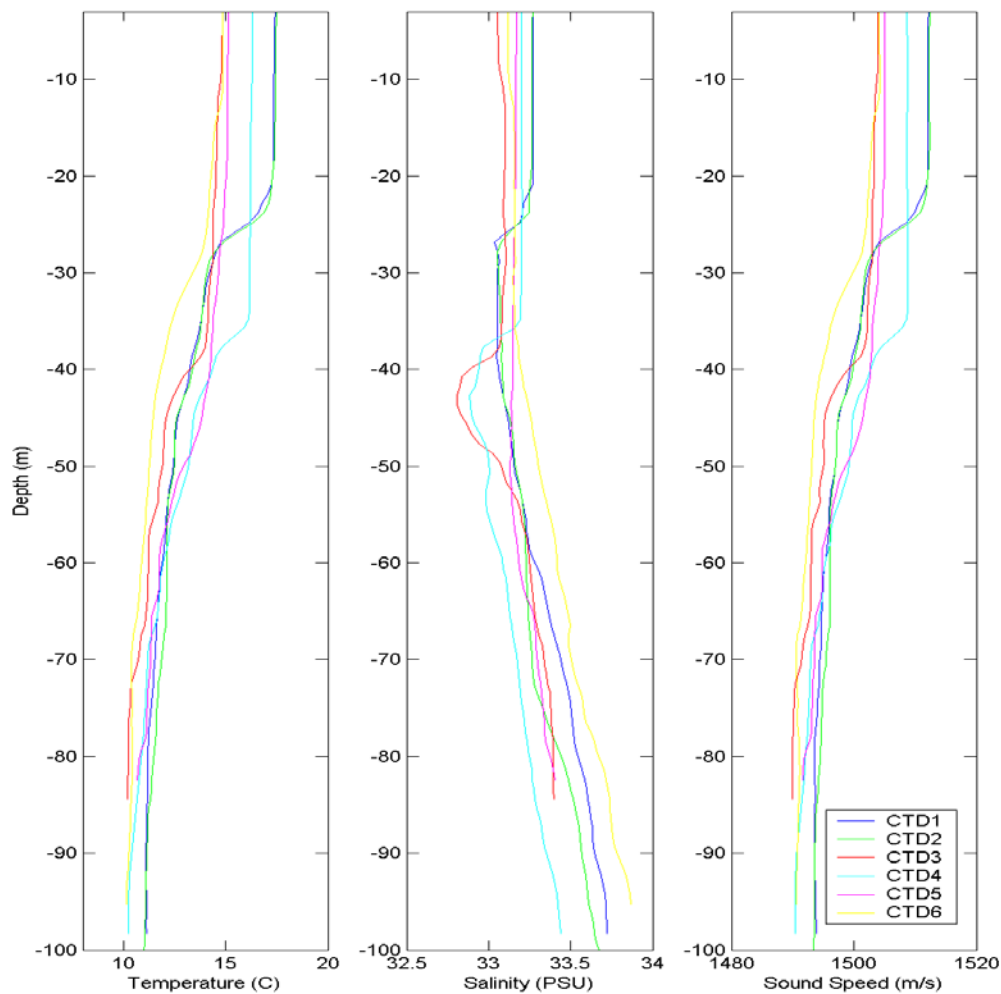

Figure 1.82. San Nicolas Island (040404) area backscatter coefficients (s_a ; m^2/m^2) attributed to seabed type.



CTD Results: All CTD profiles were conducted at Forty-Three Fathom Bank, with the exception of one at Cherry Bank. Casts at Forty-Three Fathom Bank spanned the period from 18 Nov 2003 to 12 Mar 2004. During this period, the temperature and salinity dropped at Forty-Three Fathom Bank from about 17 to 13 °C (**Fig. 1.83**). The mixed layer was shallowest, approximately 25 m depth, during the fall. The thermocline was weak during the winter with relatively stable temperature and increasing salinity below approximately 50 m.

Figure 1.83. Processed CTD profiles for OL07 cruises. All CTDs were cast at Forty-Three Fathoms with the exception of CTD03 at Cherry Bank. CTD01 & 02 were on 18 Nov 2003; CTD03 on 02 Dec 2003, CTD04 on 04 Dec 2003; CTD05 on 07 Mar 2004; CTD06 on 12 Mar 2004. The temperature and salinity dropped at Forty-Three Fathoms from Nov. thru March. Although Cherry Bank (CTD03) is further from shore relative to Forty-Three Fathom Bank (CTD04), it was influenced by a fresher and colder water mass around the same time period.



Target Strength: *TS* measurements versus depth were made at 38, 70, 120, and 200 kHz for six species of rockfish using a hook and line apparatus (**Fig. 1.84**). Individual fish were hooked and brought to the surface under the split-beam transducer. The 3 m separations between targets allowed them to be acoustically resolved (**Fig. 1.85**). Target strengths, and fish species, lengths, and masses were recorded. Measurements were made of 24 bocaccio, 12 vermillion, 7 ocean whitefish, 3 speckled and 1 squarespot rockfish. These measurements and the *TS* analysis will be presented elsewhere.

Figure 1.84. Hook and line apparatus used to make measurements of rockfishes near the seabed. Measurements were made using the pole-mounted four-frequency transducer array. A 38.1 mm diameter tungsten-carbide calibration sphere was positioned 3 m below the hook to provide a reference standard, and a weight was positioned 3 m below that to position the targets stably below the transducers.

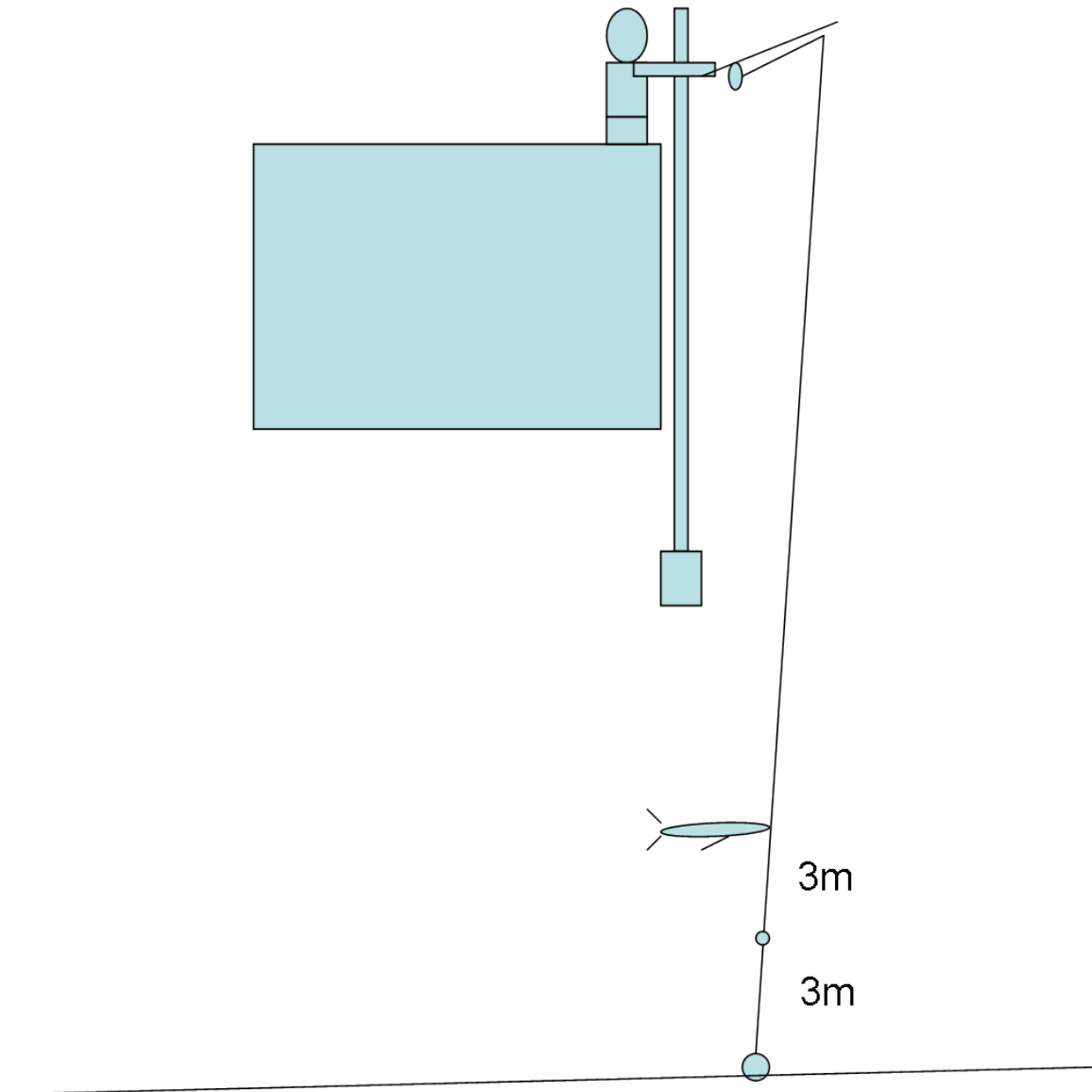
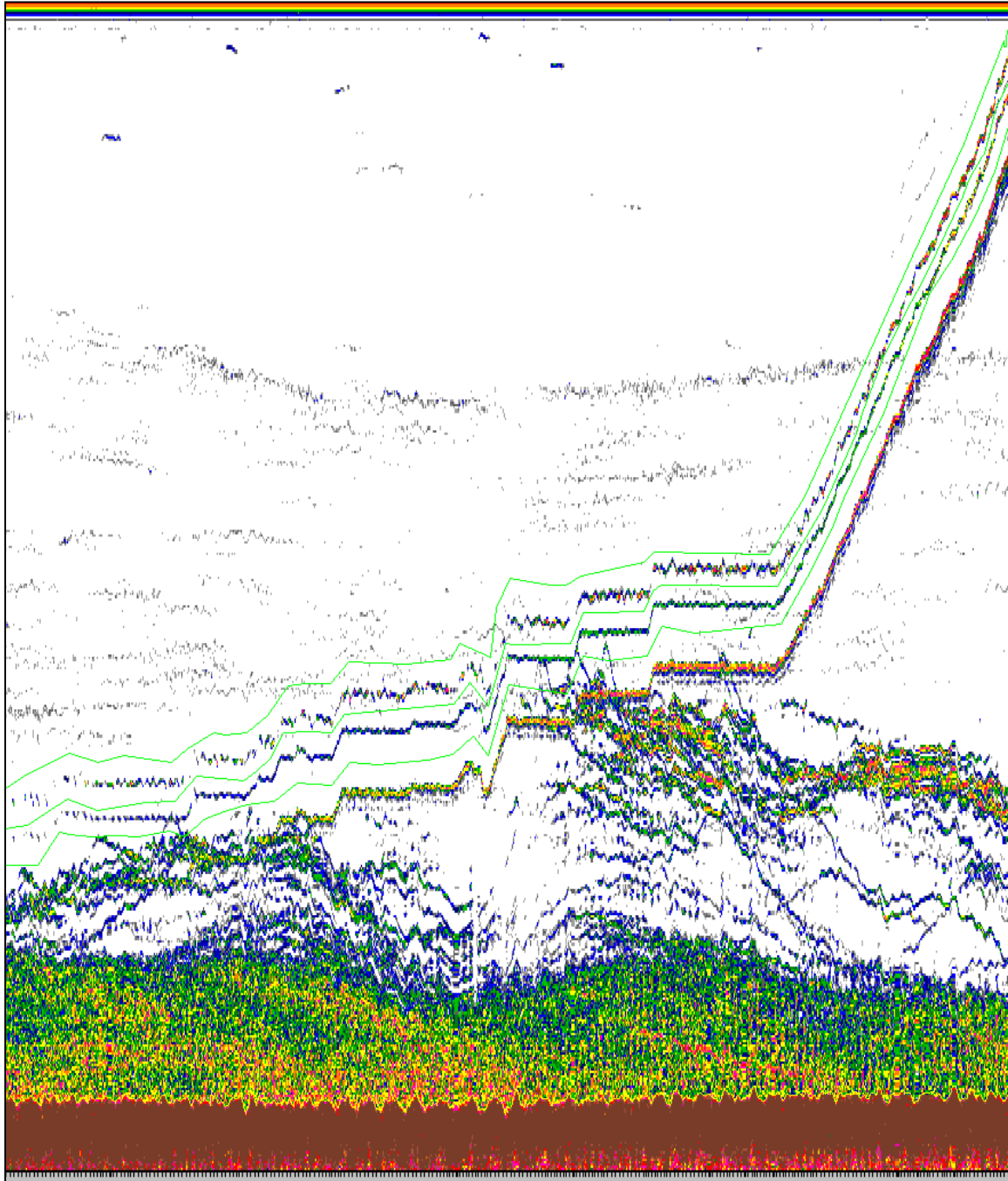

Figure 1.85. Target strength measurements versus depth were made at 38, 70, 120, and 200 kHz for six species of rockfish. Shown are echoes from three targets including: a 38.1 mm diameter tungsten-carbide standard sphere (bottom); and two hooked rockfish (top and middle). Notice the increasing scattering intensities of the rockfishes as the depth decreases and their swimbladder volumes increase.



1.5 Tentative Conclusions

Based on this preliminary investigation, rockfishes in the SCB persistently associate with certain seabed types and features, and may ascend multiple tens of meters off the seabed during daytime. One example of this behavior was documented while the ship was

anchored (seabed depth=104 m) on 4 November 2003 at 0307 GMT, at Forty-three Fathom Bank (32° 39.243'N / 117° 58.383'W). The intention was to observe the behaviors of rockfishes for 24 hours. During this period, the ship swung one complete revolution around the anchor (Fig. 1.86). Relatively no fish were observed during the nighttime hours; and schools of a variety of fish were observed to 40 m above the seabed during daylight hours (Fig. 1.87).

Figure 1.86. The position of *Outer Limits* while on anchor at Forty-three Fathom Bank for 24 hours.

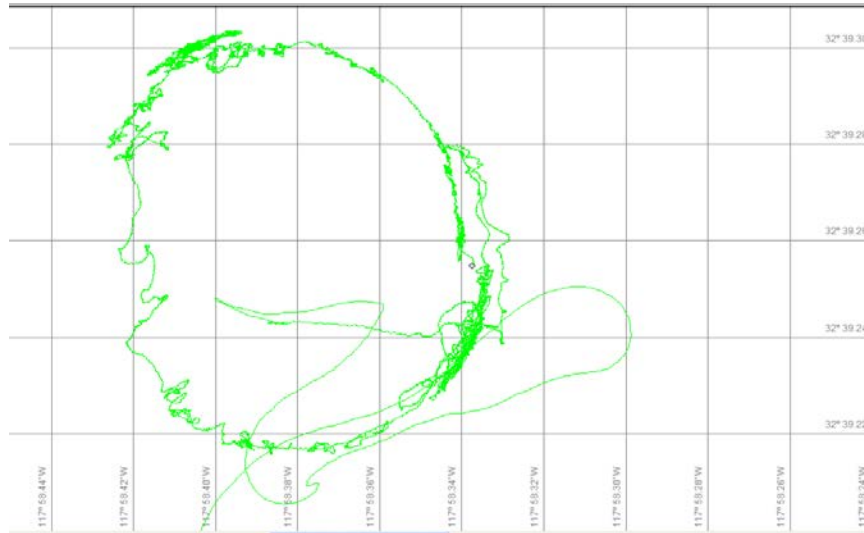
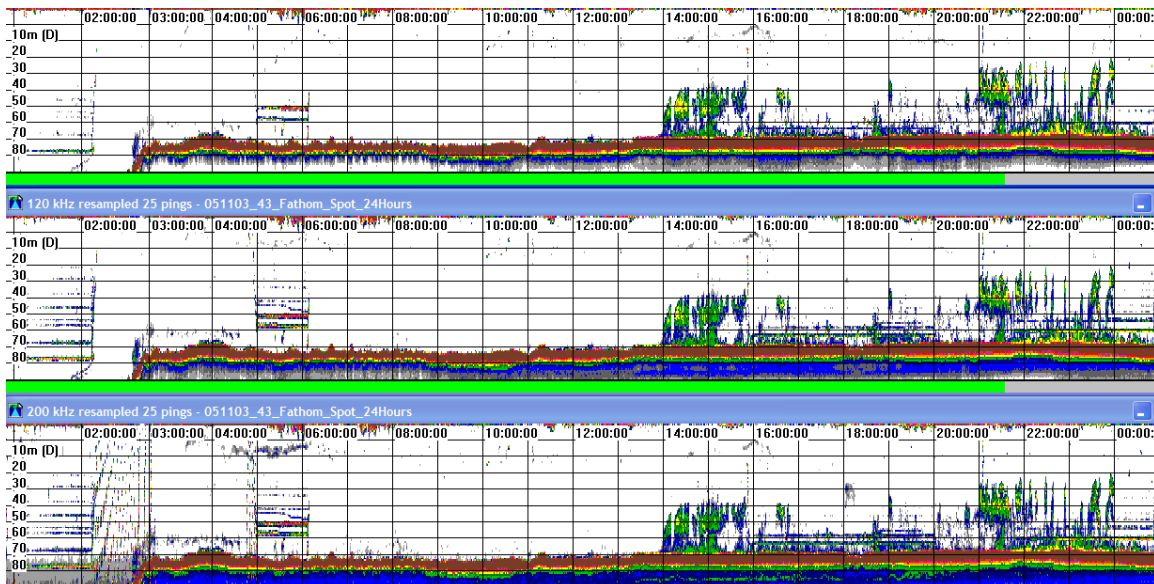
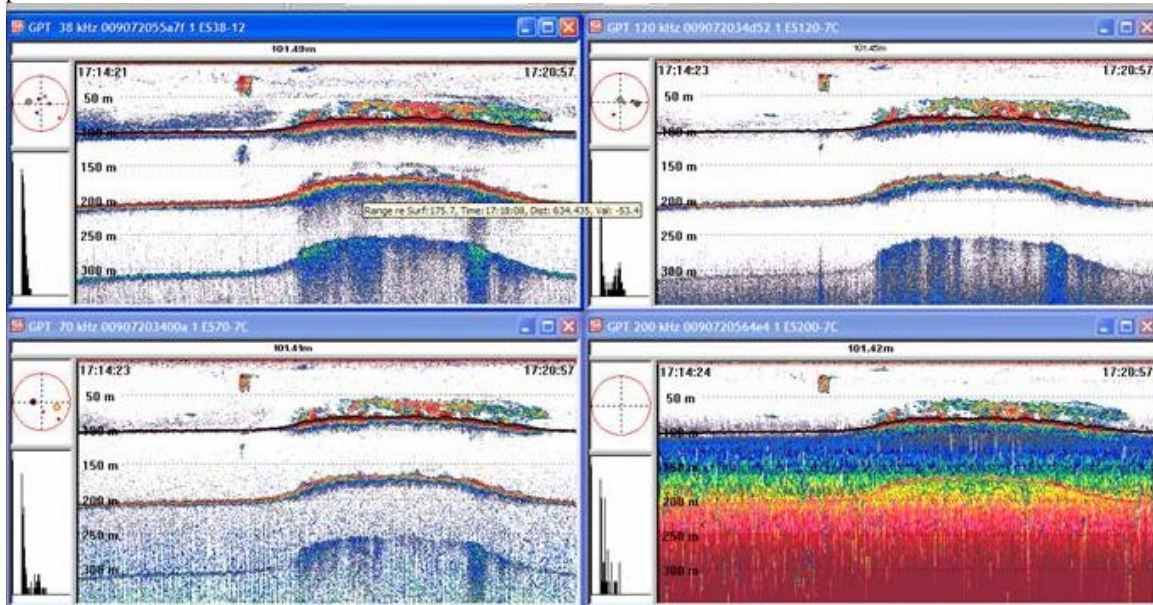

Figure 1.87. Echogram at 70, 120, and 200 kHz (top to bottom) while *Outer Limits* was at anchor for a 24 hour period at Forty-three Fathom Bank on 4 November 2003. During nighttime, the fishes are on or in the seabed and therefore undetectable by the echosounders. In stark contrast, during daytime, the rockfishes rise, many up to 50 m above the seabed.



These characteristics make at least some rockfish species available to acoustic daytime sampling with multi-frequency echosounders. The multiple-frequency acoustic backscatter information (**Fig. 88**) can be used to generate maps of rockfish densities and the seabed. These maps may be used to direct underwater optical sampling. The optical samples identify the species which comprise the acoustic backscatter, and their sizes. These data could be combined to estimate rockfish densities, distributions, and abundances, by species.

Figure 1.88. Four-frequency (38, 70, 120, and 200 kHz) echograms of pelagic fish and rockfish aggregations on the top of the Forty-Three Fathom Bank, 12 March 2004. The frequency-specific backscatter and its position relative to the seabed allows the echo energy to be apportioned to multiple taxa present.



1.6 Problems and Suggestions

Further work is needed to quantify the height above the seabed which is not acoustically sampled (aka dead zone), versus acoustic pulse lengths and beamwidths, and seabed depths, types, and slopes. It is also necessary to know how far off the seabed the various species of rockfishes naturally reside during daytime, and how the various species of rockfishes react to the ROV.

1.7 Disposition of Data

Echosounder (~60 GB), CTD (~2 MB), multi-beam sonar, thermosalinograph (~30 MB), and metadata (~10 MB) are archived by David Demer, Southwest Fisheries Science Center, 8604 La Jolla Shores Drive, La Jolla, CA, 92037, USA, david.demer@noaa.gov.

1.8 Acknowledgements

We thank Captain Ken Franke, the other captains, and the crew of CPFV *Outer Limits* for competently and enthusiastically facilitating this survey. They all gave vigilant attention to the repetitive tasks, provided good food, and were eager to assist. We are also appreciative of the ship for providing the project with cellular and satellite telephone and VHS radio communications.

1.9 References

Love MS, Yoklavich M, Thorsteinson L (2002) *The Rockfishes of the Northeast Pacific*
University of California Press, Ltd., Berkeley and Los Angeles, CA

2. Optical surveys using a remotely operated vehicle (ROV), submitted K. L. Stierhoff and J. L. Butler

2.1 Objectives

The research objective was to conduct visual transect surveys using a remotely operated vehicle (ROV) at offshore banks previously surveyed using multibeam and multi-frequency split-beam acoustic sampling methods described in detail above. These surveys aimed to 1) provide general information on rockfish community structure (e.g., relative abundance, size distributions, and seabed associations) to aid in the apportioning of acoustic backscatter from fish targets, and 2) provide visual data on seabed composition to ground-truth acoustic survey results.

2.2 Accomplishments

A total of 29 ROV transect surveys covering a distance of ~51 km were conducted at 9 nominal sites during daylight hours between 5 November 2003 and 3 April 2004 (**Table 2.1**). Over 151,000 rockfishes and thornyheads (~26 species) were identified and quantified between 0 and 250 m depth. Each observation included the date/time, latitude/longitude, depth, temperature, size class, and seabed association.

Table 2.1. Summary of visual surveys conducted within the acoustic survey areas using the SWFSC remotely operated vehicle (ROV) during the COAST 2003 surveys.

Site name	# of dives	Latitude	Longitude	Avg depth
43 Fathom Bank	11	32.650	-117.970	-96
Cherry Bank	4	32.900	-119.440	-280
Lasuen Knoll	3	33.400	-118.000	-159
NW San Clemente Island	1	32.990	-118.620	-84
Osborne Bank	1	33.360	-119.050	-89
Potato Bank	2	33.260	-119.820	-95
S Tanner Bank	5	28.690	-122.490	-130
San Clemente Island	1	32.940	-118.500	-135
SE San Nicolas Island	1	33.220	-119.270	-87
All sites	29			

2.3 Methods

Visual transect surveys were conducted in areas of high acoustic backscatter, as identified by earlier split-beam acoustic surveys (e.g., **Fig. 1.2**, above), using an ROV (Deep Ocean Engineering, Inc. Phantom DS4) fitted with a forward-looking color-video camera (Sony FCB-IX47C) with 470 lines of horizontal resolution and an 18x optical zoom. For

improved species identification, the ROV was also fitted with a high-resolution-still camera (Insite Pacific, Inc. Scorpio with Nikon Coolpix 995) with 4x zoom. The location of the ROV relative to the ship was estimated using an acoustic transponder. The position of the ROV above the seabed and speed-over-ground was estimated in real-time using an ultra-short baseline (USBL) acoustic tracking system (ORE Offshore TrackPoint II-Plus) and tracking software (Fugro Pelagos, Inc. WinFrog). All other navigational data (e.g., seawater depth and temperature; ROV heading and speed; and camera pitch, roll, and altitude) were synchronously logged at one-to-two second intervals using WinFrog. Since speed data were unreliable and USBL data were often noisy, the distance of each ROV transect (d) was estimated from the relationship between dive duration (t , hours) and total distance in subsequent ROV transects with more accurate distances ($d = 1275.8 * t$, $n = 58$ transects, $r^2 = 0.82$).

All adult rockfishes and thornyheads were identified to the lowest possible taxonomic level and counted (**Table 2.1**). Unidentifiable rockfishes (765 rosy-group rockfish, subgenus *Sebastomus*; and 28,548 other unidentified rockfishes, genus *Sebastes*), were also counted. Although this survey focused on rockfishes and thornyheads, all other observed fishes were also identified and quantified to the lowest level possible taxonomic level (data not shown). Fish lengths were estimated using two pairs of parallel reference lasers (20 and 61cm spacing) mounted on the camera platform, and later grouped into four broad size classes: < 10 cm, 10 – 25 cm, 25 – 60 cm, and >60 cm total length (TL).

2.4 Preliminary Results

A total of 29 ROV transect surveys from 30-250 m depths (**Fig. 2.1**) covering a distance of ~51 km. Approximately 40 hours of video and 2,400 high-resolution still images were collected. Camera pitch and altitude data were not available for these surveys.

A total of 151,205 individual fishes representing 26 rockfish species were identified and quantified (**Table 2.2**). Three species (*S. hopkinsi*, *S. jordani*, and *S. wilsoni*) comprised ~57% of the fish community. These most abundant species were small, schooling or aggregating species. Approximately 19% of the fish community comprised unidentified rockfishes (*Sebastes* or *Sebastomus* sp.), which were likely among the four most abundant species that were identifiable to the species level. Occasionally large, mixed assemblages were encountered, and were assigned to various complexes: *Sebastes* Complex 1 (*S. rufus*, *S. entomelas*, *S. ovalis*, or *S. hopkinsi*, ~6.5%), *Sebastes* Complex 2 (*S. moseri*, *S. wilsoni*, *S. ensifer*, or *S. semicinctus*, ~2%), *Sebastes* Complex 3 (*S. chlorostictus*, or *S. rosenblatti*, < 1%) *Sebastes* Complex 4 (dwarf rockfish complex, <<1%) (**Table 2.2**). The greatest relative abundance (~99%) and species richness (total number of species) were shallower than 150 m (**Table 2.2**). The distribution of individuals by size class was as follows: <10 cm (9%), 10-25 cm (75%), 25-60 cm (16%), and >60 cm (<1%).

Figure 2.1. Distributions of ROV depth during the COAST 2003 survey.

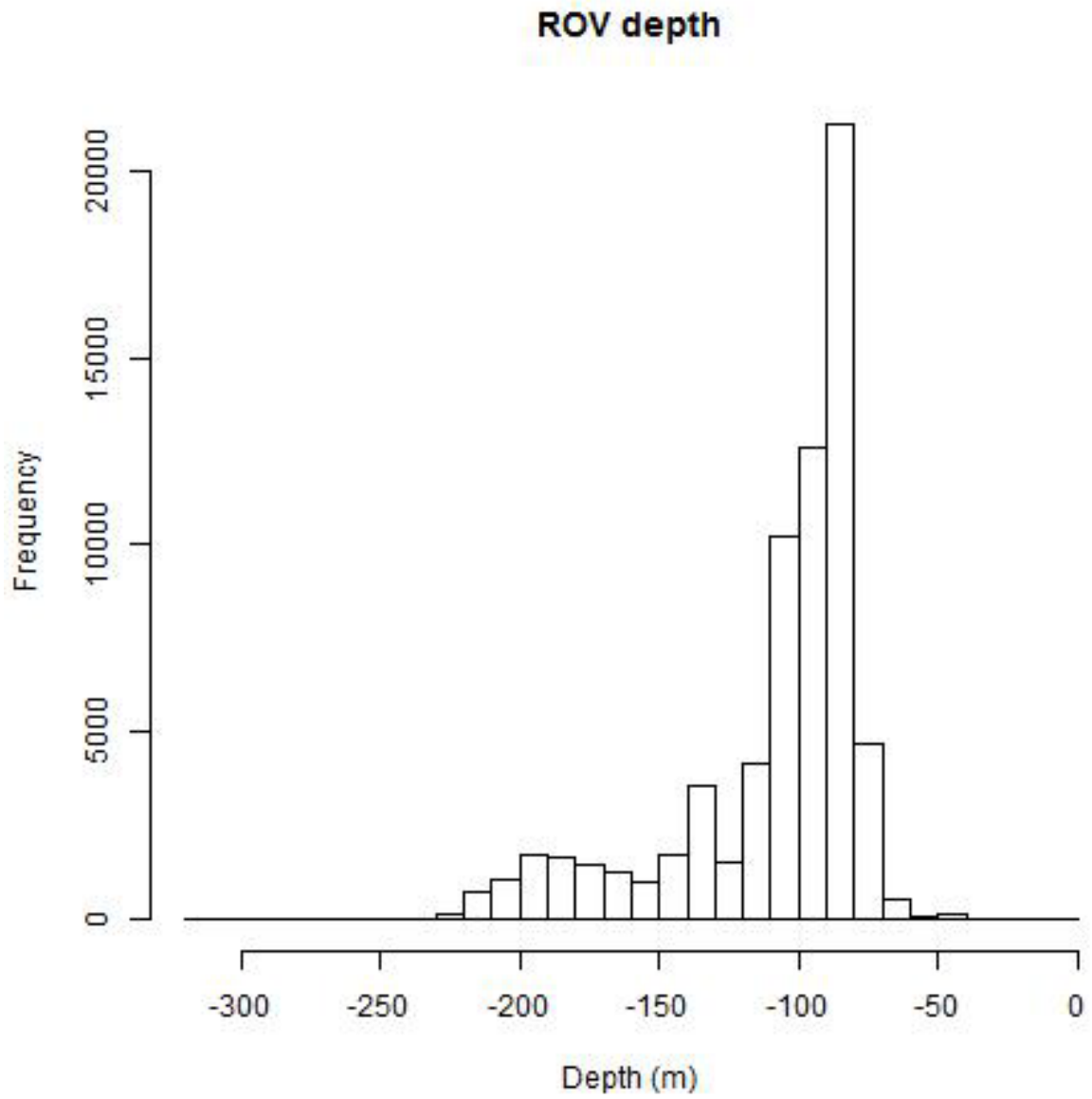

Table 2.2. Relative abundances (number of individuals km⁻¹) by depth of rockfish species during the COAST 2003 surveys. Species are sorted from shallow to deep using the depth stratum where each species was most abundant. The color scale indicates the depth strata where each species is least (green) to most (red) abundant.

Scientific name	Common name	Depth (m)				% total
		50-99	100-149	150-199	200-249	
Sebastes Complex 1	Sebastes Complex 1	505.077	55.649			6.5%
<i>Sebastes semicinctus</i>	Halfbanded rockfish	233.589	7.388			2.8%
<i>Sebastes Complex 2</i>	Sebastes Complex 2	126.925	2.033			1.5%
<i>Sebastes moseri</i>	Whitespeckled rockfish	32.987	11.659			0.5%
<i>Sebastes rosaceus</i>	Rosy rockfish	17.415	1.152			0.2%
<i>Sebastes mystinus</i>	Blue rockfish	1.842				0.1%
<i>Sebastes serranoides</i>	Olive rockfish	1.451				0.1%
<i>Sebastes ruberrimus</i>	Yelloweye rockfish	0.781	0.136			0.1%
<i>Sebastes caurinus</i>	Copper rockfish	0.447				0.1%
<i>Sebastes rosenblatti</i>	Greenblotched rockfish	0.112	0.068			0.1%
<i>Sebastes hopkinsi</i>	Squarespot rockfish	1548.051	150.951	0.138		19.8%
<i>Sebastes sp.</i>	Rockfish-unidentified	1071.607	617.633	15.118	4.290	18.9%
<i>Sebastes wilsoni</i>	Pygmy rockfish	482.862	171.286	0.276		7.4%
<i>Sebastes ovalis</i>	Speckled rockfish	297.721	24.198	0.069		3.8%
<i>Sebastomus sp.</i>	Rosy-group rockfish	31.089	11.049	2.140	3.337	0.5%
<i>Sebastes constellatus</i>	Starry rockfish	11.331	2.372	0.138		0.2%
<i>Sebastes jordani</i>	Shortbelly rockfish	1129.433	1691.713	4.763		29.9%
<i>Sebastes ensifer</i>	Swordspine rockfish	61.286	316.408	82.146	13.348	4.6%
<i>Sebastes paucispinis</i>	Bocaccio	64.132	64.800	5.315		1.4%
<i>Sebastes Complex 4</i>	Sebastes Complex 4	15.294	44.940			0.6%
<i>Sebastes miniatus</i>	Vermilion rockfish	3.182	32.061	1.726		0.4%
<i>Sebastes levis</i>	Cowcod	3.684	22.368	1.381		0.3%
<i>Sebastes rufinanus</i>	Dwarf-red rockfish	4.409	8.473			0.1%
<i>Sebastes chlorostictus</i>	Greenspotted rockfish	4.856	6.439	0.483		0.1%
<i>Sebastes rubrivinctus</i>	Flag rockfish	1.786	2.237	0.414		0.1%
<i>Sebastes gilli</i>	Bronzespotted rockfish		1.288	0.069		0.1%
<i>Sebastes Complex 3</i>	Sebastes Complex 3		0.542			0.1%
<i>Sebastes helvomaculatus</i>	Rosethorn rockfish		0.339			0.1%
<i>Sebastes goodei</i>	Chilipepper rockfish	0.056	0.068			0.1%
<i>Sebastes pinniger</i>	Canary rockfish		0.068			0.1%
<i>Sebastes rufus</i>	Bank rockfish	2.512	7.998	4.349	2.622	0.2%
<i>Sebastes elongatus</i>	Greenstripe rockfish	0.167	2.779	1.519	0.238	0.1%
All species		5654.084	3258.097	120.0438	23.8356	
Number of species		28	29	16	5	

Many of the rockfish species occurred over a wide range of seabed types (**Table 2.3**), from sand to high-relief reef. However, most species (~87% of individuals) were most commonly observed over hard seabeds with low- to high-relief (cobble or larger). The greatest species richness (total number of species) occurred in in the cobble seabed type, but a large number of species were observed over all seabed types except low-relief reef.

Table 2.3. Relative abundances (% of total observations) by seabed type of rockfish species during the COAST 2003 surveys. Species are sorted by seabed type, from low- (sand) to high-relief (high-relief reef) seabeds, where each species was most abundant. The color scale indicates the seabed type where each species is least (green) to most (red) abundant.

Scientific name	Common name	Sand	Cobble	Boulder	Low-relief reef	High-relief reef	% total
<i>Sebastes elongatus</i>	Greenstripe rockfish	80.4%		19.6%			0.1%
<i>Sebastes helvomaculatus</i>	Rosethorn rockfish	100.0%					0.1%
<i>Sebastes rosenblatti</i>	Greenblotched rockfish	100.0%					0.1%
<i>Sebastes caurinus</i>	Copper rockfish	25.0%	75.0%				0.1%
<i>Sebastes wilsoni</i>	Pygmy rockfish	9.1%	51.0%	14.4%	0.9%	24.5%	8.6%
<i>Sebastes semicinctus</i>	Halfbanded rockfish	12.6%	66.0%	18.1%	0.7%	2.7%	7.2%
Sebastes Complex 2	Sebastes Complex 2		86.8%	12.3%		0.9%	4.2%
<i>Sebastes chlorostictus</i>	Greenspotted rockfish	41.1%	5.3%	52.6%		1.1%	0.2%
<i>Sebastes ensifer</i>	Swordspine rockfish	12.2%	25.4%	38.5%	1.8%	22.2%	2.3%
Sebastes Complex 1	Sebastes Complex 1	50.6%		2.2%		47.2%	1.1%
<i>Sebastes miniatus</i>	Vermilion rockfish	25.3%	0.8%	70.9%	0.2%	2.8%	0.9%
<i>Sebastes levis</i>	Cowcod		0.6%	93.1%		6.3%	0.6%
<i>Sebastes sp.</i>	Rosy-group rockfish	4.1%	4.5%	82.2%	1.2%	7.9%	0.4%
<i>Sebastes rufinanus</i>	Dwarf-red rockfish		37.1%	41.1%		21.7%	0.3%
<i>Sebastes rufus</i>	Bank rockfish	9.1%		90.9%			0.2%
<i>Sebastes rubrivinctus</i>	Flag rockfish	15.4%	3.8%	73.1%		7.7%	0.1%
<i>Sebastes gilli</i>	Bronzespotted rockfish			100.0%			0.1%
<i>Sebastes serranoides</i>	Olive rockfish			58.8%		41.2%	0.1%
<i>Sebastes sp.</i>	Rockfish-identified	13.1%	6.2%	37.4%	6.4%	36.9%	19.5%
<i>Sebastes jordani</i>	Shortbelly rockfish	0.8%	39.0%	5.8%		54.4%	16.8%
<i>Sebastes paucispinis</i>	Bocaccio	16.7%	2.1%	60.3%		20.9%	2.2%
<i>Sebastes constellatus</i>	Starry rockfish	3.0%	7.0%	52.0%		38.0%	0.2%
<i>Sebastes hopkinsi</i>	Squarespot rockfish	19.4%	6.6%	23.5%	0.1%	50.4%	32.8%
<i>Sebastes ovalis</i>	Speckled rockfish	16.6%	3.1%	19.6%	0.1%	60.6%	1.4%
<i>Sebastes moseri</i>	Whitespeckled rockfish			36.5%		63.5%	0.7%
<i>Sebastes rosaceus</i>	Rosy rockfish	20.8%	2.8%	22.2%	1.4%	52.8%	0.1%
<i>Sebastes ruberrimus</i>	Yelloweye rockfish	20.0%				80.0%	0.1%
Number of species		21	18	23	9	21	

2.5 Tentative Conclusions

The preliminary results from the ROV surveys provided information on the species composition, depth distribution, and seabed associations of rockfishes and thornyheads in the acoustic survey areas. The images collected with cameras on the ROV also provided information about the proportions of various rockfish species present in each survey area, and their length distributions throughout the SCB. These estimates of species proportions and lengths are used to convert the acoustic backscatter from rockfishes to estimates of their abundances, by species. The geolocated observations of seabed type are being used to ground-truth model results that predict seabed type from multiple-frequency echo amplitude and interferometric-phase information.

2.6 Problems and Suggestions

The use of high-definition (HD) video could greatly improve the ability of analysts to identify more fishes without the aid of still images, thereby improving the time efficiency of video analysis, and would likely allow for the identification of many species that were only able to be identified as *Sebastes* or *Sebastomus* sp. Methods are being developed that allowed for better and more length estimates of fishes (e.g., stereo images or video). These could reduce error associated with the calculation of species-specific biomass using the visual and acoustic data.

2.7 Disposition of Data

Video and still camera images, and ROV metadata are archived by John Butler (john.butler@noaa.gov), NOAA Fisheries, Southwest Fisheries Science Center, 8604 La Jolla Shores Drive, La Jolla, CA, 92037, USA.

2.8 Acknowledgements

The analysis of video footage was done by S. Mau, D. Murfin, D. Pinkard-Meier, K. Stierhoff, and M. Wilson.

RECENT TECHNICAL MEMORANDUMS

SWFSC Technical Memorandums are accessible online at the SWFSC web site (<http://swfsc.noaa.gov>). Copies are also available from the National Technical Information Service, 5285 Port Royal Road, Springfield, VA 22161 (<http://www.ntis.gov>). Recent issues of NOAA Technical Memorandums from the NMFS Southwest Fisheries Science Center are listed below:

- NOAA-TM-NMFS-SWFSC-486 Spawning biomass of Pacific sardine (*Sardinops sagax*) off U.S. in 2011. N.C.H. LO, B.J. MACEWICZ, and D.A. GRIFFITH (November 2011)
- 487 Assessment of the Pacific sardine resource in 2011 for U.S. management in 2012. K.T. HILL, P.R. CRONE, N.C.H. LO, B. MACEWICZ, E. DORVAL, J.D. McDANIEL, and Y. GU (November 2011)
- 488 U.S. Pacific marine mammal stock assessments: 2011. J.V. CARRETTA, K.A. FORNEY, E. OLESON, K. MARTIEN, M.M. MUTO, M.S. LOWRY, J. BARLOW, J. BAKER, B. HANSON, D. LYNCH, L. CARSWELL, R.L. BROWNELL Jr., J. ROBBINS, D.K. MATTILA, K. RALLS, and M.C. HILL (April 2012)
- 489 The Winter-Run Harvest Model (WRHM). M.R. O'FARRELL, S.D. ALLEN, and M.S. MOHR (May 2012)
- 490 Density and spatial distribution patterns of cetaceans in the central North Pacific based on habitat models. E.A. BECKER, K.A. FORNEY, D.G. FOLEY, and J. BARLOW (June 2012)
- 491 Sacramento River winter Chinook cohort reconstruction: analysis of ocean fishery impacts. M.R. O'FARRELL, M.S. MOHR, A.M. GROVER, and W.H. SATTERTHWAITTE (August 2012)
- 492 Ichthyoplankton and station data for surface (Manta) and oblique (Bongo) plankton tows for California Cooperative Oceanic Fisheries Investigations Cruises and California Current Ecosystem Survey in 2009. A.R. THOMPSON, W. WATSON, and S.M. MANION (July 2012)
- 493 A description of the tuna-porpoise observer data collected by the U.S. National Marine Fisheries Service 1971 to 1990. A.R. JACKSON (November 2012)
- 494 California Coastal Chinook salmon: status, data, and feasibility of alternative fishery management strategies. M.R. O'FARRELL, W.H. SATTERTHWAITTE, and B.C. SPENCE (November 2012)
- 495 Cruise report for the Vaquita Expedition 2008 conducted aboard NOAA Ship *David Starr Jordan*, *R/V Koipai YÚ-XÁ*, and the *Vaquita Express*. A HENRY, B. TAYLOR, L. ROJAS-BRACHO, S. RANKIN, A. JARAMILLO-LEGORETTA, T. AKAMATSU, J. BARLOW, T. GERRODETTE, C. HALL, A. JACKSON, J. REDFERN, R. SWIFT, and N. TREGENZA (September 2012)